

PVC FITTINGS & VALVES



Technical Catalogue

INTRODUCTION

Plasson's innovative products revolutionized the way of connecting polyethylene pipes in the 1960's. We started with fittings for agricultural irrigation and later developed products for urban water distribution.

High pressure PVC Fittings and Valves are part of Plasson's wide range of products. Plasson has achieved superior designs and products and a genuine commitment to quality, delivery and service.

Plasson continues to strive for the future environment. By buying Plasson products you help us invest in our vision of a world where clean, pure water will be everyone's birthright.

INTRODUCTION

CEMENTED FITTINGS	8-17
ADAPTOR FITTINGS	18-24
THREADED FITTINGS	25-31
FITTINGS ACCESSORIES	32-35
VALVES NORMAL SUPPORT	36-37
VALVES THREADED SUPPORT	38-43
CHECK VALVES	44-45
FOOT VALVES	46
AIR RELEASE VALVES	47
VALVES ACCESSORIES	48-52
TECHNICAL SPECIFICATIONS - FITTINGS	53-54
TECHNICAL SPECIFICATIONS - VALVES	55-56
ASSEMBLY INSTRUCTIONS	57-62

PRODUCT LIST

5010 - 050100
Socket - Cemented
page 8



5450 - 054500
45° Elbow - Cemented
page 14



5020 - 050200
Reducing Socket
Male - Female - Cemented
page 9



5500 - 055000
Flange Adaptor with O-Ring Cemented
page 14



5040 - 050400
90° Tee - Cemented
page 10



5510 - 055100
Stub Flat Face to fit
Cemented
page 15

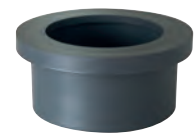

5050 - 050500
90° Elbow - Cemented
page 10



5520 - 055200
Stub Serrated
Cemented
page 15

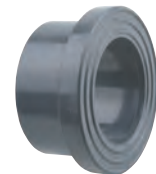

5070 - 050700
End Cap - Cemented
page 11



5900 - 059000
Loose Flange
page 16



5080 - 050800
Union - Cemented
page 11



5910 - 059100
Blind Flange
page 16



5090 - 050900
Short Reducing Bushing - Cemented
page 12

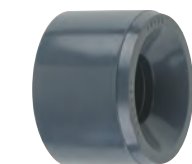

5920 - 059200
Fixed Flange
page 17



5140 - 051400
90° Reducing Tee
Cemented
page 13



5012 - 050102
Socket Adaptor
Cemented Threaded
page 18



5360 - 053600
Hose Adaptor
Cemented
page 13



5022 - 050202
Reducer Adaptor
M - F - Cemented Threaded
page 18



PRODUCT LIST

5032 - 050302
Adaptor Socket
M - F - Cemented - Threaded
page 18



5142 - 051402
90° Reducing Tee
Cemented - Threaded
page 21



5042 - 050402
90° Tee
Cemented Threaded
page 19



5712 - 057102
Socket Adaptor Cemented
Threaded with Reinforcing Ring
page 22



5052 - 050502
90° Elbow
Cemented Threaded
page 19



5722 - 057202
Reducer Adaptor with Reinforcing Ring Male
Cemented - Female - Threaded
page 22

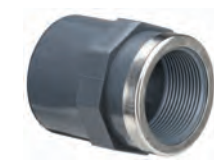

5062 - 050602
Adaptor
M - F - Cemented - M - Threaded
page 19



5742 - 057402
90° Tee with Reinforcing Ring Cemented Threaded
page 23



5082 - 050802
Union Adaptor
F - Cemented - Threaded
page 20



5752 - 057502
90° Elbow with Reinforcing Ring Cemented Threaded
page 23



5212 - 052102
Adaptor
M - F - Cemented - M - Threaded
page 20



5732 - 057302
Adaptor Socket
Reinforcing Ring M - F
page 24



5222 - 052202
Bushing Adaptor
M - F - Cemented - M - Threaded
page 20



5011 - 050101
Socket - Threaded
page 25



5362 - 053602
Hose Adaptor
With Threaded Nut
page 21



5013 - 050103
Reducing Socket
Female - Female - Threaded
page 25



5452 - 054502
45° Elbow
Cemented - Threaded
page 21



5021 - 050201
Reducer
Male - Female - Threaded
page 26



PRODUCT LIST

5041 - 050401
90° Tee

Threaded
page 26



5361 - 053601
Hose Adaptor

Threaded
page 30



5051 - 050501
90° Elbow

Threaded
page 27



5221 - 052201
Nipple Socket

Male - Female - Threaded
page 30



5061 - 050601
Nipple

Threaded
page 27



5451 - 054501
45° Elbow

Threaded
page 31



5071 - 050701
Cap

Threaded
page 27



5921 - 059201
Fixed Flange

Threaded
page 31



5081 - 050801
Union Female

Threaded
page 28



5480 - 054800
Nut for Unions:

page 32



5083 - 050803
Union Male - Female

Cemented Threaded
page 28



5580 - 055800
Bushing for Union:

page 32



5084 - 050804
Union

Male - Female - Threaded
page 28



5581 - 055801
Bushing for Unions:

page 32



5161 - 051601
Reducing Nipple

Threaded
page 29



5583 - 055803
Male Threaded Union bush

page 33



5171 - 051701
Plug

Threaded
page 30



5680 - 056800
End for Unions:

page 33



PRODUCT LIST

5681 - 056801
End for Unions



page 33

1140 - 11140
Two Nut Valve



Cemented
page 38

5690 - 056090
O-Ring for Item



page 34

1141 - 11141
Two Nut Valve



Threaded
page 38

5629 - 056290
Seal



page 34

1140A
Two Nut Valve
Cemented - Potable water
page 39



O-R - 056390
O-Ring for Unions



page 35

1141A
Two Nut Valve
Threaded - Potable water
page 39



1150 - 11150
Two Nut Valve
Cemented
page 36



1240 - 11240
1270 - 11270*
Bistop Valve Cemented
page 40



1151 - 11151
Two Nut Valve
Threaded
page 36



1241 - 11241
1271 - 11271*
Bistop Valve Threaded
page 40



1350 - 11350
One Nut Valve
Cemented
page 37



1340 - 11340
One Nut Valve
Cemented
page 41



1351 - 11351
One Nut Valve
Threaded
page 37



1341 - 11341
One Nut Valve
Threaded
page 41



1361 - 11361
One Nut Valve
Male - Female - Threaded
page 37



1371 - 11371
One Nut Valve
Male - Female - Threaded
page 42



PRODUCT LIST

1379 - 11379

Compression Valve

Female - Threaded - Compression

page 42



1631 - 11631

1691 - 11691

Air Release Valve Threaded

page 47



1148 - 111480

Two Nut Valve

PE End Connector

page 43



EI - 11110

Valve End

Cemented

page 48



1378 - 11378

Compression Valve

PE End

Connector

page 43



EF - 11111

Valve End

Threaded

page 48



1180 - 11080 1160 - 11060

1190 - 11090 1000 - 11000

Check Valve Cemented

page 44



MB - 11112

Blue Handle

page 49



1181 - 11081 1161 - 11061

1191 - 11091 1001 - 11001

Check Valve Threaded

page 44



MR - 11113

Red Handle

page 49



5048 - 050408

Knocker Tee

Cemented

page 45



MBA

BlueA Handle

page 49



1640 - 11640

1600 - 11600

Foot Valve Cemented

page 46



GH - 11114

Valve Nut

page 50



1641 - 11641

1601 - 11601

Foot Valve Threaded

page 46



PEI - 1115.207

PE End Connector

page 50



1630 - 11630

1690 - 11690

Air Release Valve Cemented

page 47



PVC CEMENTED FITTINGS

Socket - Cemented

Cod MG
5010

Cod Plasson
050100

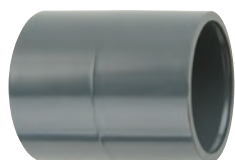

Quality	Cod MG	Cod Plasson	d	E	H	I	Z	Weight	PN	Pack
U C K	5010016	050100016	16	21	30	14	2	7	16	2500
U C K	5010020	050100020	20	25	35	16	3	8	16	1500
U C K	5010025	050100025	25	30	42	19	4	11	16	1000
U C K	5010032	050100032	32	38	48	22	4	20	16	600
U C K	5010040	050100040	40	48	56	26	4	42	16	300
U C K	5010050	050100050	50	58	66	31	4	64	16	180
U C K	5010063	050100063	63	73	80	38	4	119	16	100
U C K	5010075	050100075	75	88	93	44	5	234	16	100
U C K	5010090	050100090	90	104	108	51	6	325	16	60
U C	5010110	050100110	110	126	128	61	6	525	16	28
U	5010125	050100125	125	143	145	69	7	803	16	24
U	5010140	050100140	140	161	160	76	8	1074	16	18
U	5010160	050100160	160	181	181	86	9	1339	16	9
U	5010200	050100200	200	228	224	106	12	2778	10	4
	5010225	050100225	225	250	257	119	19	3670	10	3
	*5010250	*050100250	250	287	275	133	10	5800	10	2
	*5010280	*050100280	280	320	304	147	10	7750	10	1
	*5010315	*050100315	315	355	342	165	12	9820	10	1

Quality certifications : U= UNI-IIP, C= NF-CSTB, K = Kiwa

* DELIVERY PROGRAM

PVC CEMENTED FITTINGS

Reducing Socket
Male - Female - Cemented

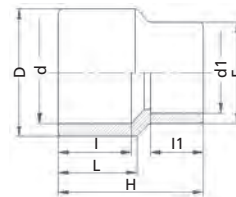

Cod MG
5020

Cod Plasson
050200

Cod MG	Cod Plasson	Dxdxd1	L	I	I1	E	H	Weight	PN	Pack
5020020016	050200020016	20 x 16 x 16	16	14	14	20	36	6	16	3000
5020025016	050200025016	25 x 20 x 16	19	16	14	22	39	10	16	1500
5020025020	050200025020	25 x 20 x 20	19	16	16	25	42	10	16	1500
5020032016	050200032016	32 x 25 x 16	22	19	14	22	41	15	16	1000
5020032020	050200032020	32 x 25 x 20	22	19	19	25	45	16	16	1000
5020032025	050200032025	32 x 25 x 25	22	19	19	31	50	20	16	800
5020040016	050200040016	40 x 32 x 16	26	22	14	22	50	23	16	800
5020040020	050200040020	40 x 32 x 20	26	22	16	26	52	26	16	700
5020040025	050200040025	40 x 32 x 25	26	24	19	32	49	27	16	500
5020040032	050200040032	40 x 32 x 32	26	22	29	39	57	35	16	500
5020050020	050200050020	50 x 40 x 20	31	26	16	27	61	50	16	400
5020050025	050200050025	50 x 40 x 25	31	26	19	33	62	50	16	300
5020050032	050200050032	50 x 40 x 32	33	26	22	40	65	55	16	300
5020050040	050200050040	50 x 40 x 40	31	26	26	49	69	65	16	300
5020063025	050200063025	63 x 50 x 25	38	31	19	32	72	88	16	170
5020063032	050200063032	63 x 50 x 32	38	31	22	40	76	93	16	170
5020063040	050200063040	63 x 50 x 40	38	33	26	49	79	100	16	150
5020063050	050200063050	63 x 50 x 50	34	31	47	61	85	123	16	150
5020075032	050200075032	75 x 63 x 32	44	38	22	40	86	120	16	190
5020075040	050200075040	75 x 63 x 40	44	38	26	49	87	130	16	170
5020075050	050200075050	75 x 63 x 50	44	41	42	61	92	150	16	150
5020075063	050200075063	75 x 63 x 63	44	38	38	73	100	163	16	110
5020090040	050200090040	90 x 75 x 40	51	44	26	49	99	225	16	110
5020090050	050200090050	90 x 75 x 50	51	44	31	62	103	232	16	100
5020090063	050200090063	90 x 75 x 63	51	44	38	74	111	259	16	100
5020090075	050200090075	90 x 75 x 75	51	44	44	89	117	290	16	80
5020110050	050200110050	110 x 90 x 50	61	51	31	61	117	410	16	80
5020110063	050200110063	110 x 90 x 63	61	51	38	76	125	441	16	65
5020110075	050200110075	110 x 90 x 75	61	51	44	90	133	490	16	35
5020110090	050200110090	110 x 90 x 90	61	51	51	106	138	545	16	45
5020125063	050200125063	125 x 110 x 63	69	61	38	78	121	460	16	44
5020125075	050200125075	125 x 110 x 75	69	61	44	90	125	460	16	44
5020125090	050200125090	125 x 110 x 90	69	61	51	104	126	460	16	44
5020125110	050200125110	125 x 110 x 110	69	61	61	123	127	440	16	32
5020140110	050200140110	140 x 125 x 110	76	69	61	130	149	645	16	24
5020160110	050200160110	160 x 140 x 110	86	76	61	130	157	825	16	25
5020160125	050200160125	160 x 140 x 125	86	76	69	145	160	890	16	18
5020225160	050200225160	225 x 200 x 160	119	106	86	185	230	2100	10	6

PVC CEMENTED FITTINGS

90° Tee - Cemented

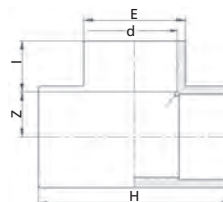

Cod MG
5040

Cod Plasson
050400

Quality	Cod MG	Cod Plasson	d	E	H	l	Z	Weight	PN	Pack
U C K	5040016	050400016	16	23	46	14	9	18	16	1500
U C K	5040020	050400020	20	27	55	16	12	22	16	700
U C K	5040025	050400025	25	30	65	19	14	44	16	500
U C K	5040032	050400032	32	40	78	22	17	54	16	250
U C K	5040040	050400040	40	48	99	26	23	97	16	130
U C K	5040050	050400050	50	62	118	28	28	208	16	80
U C K	5040063	050400063	63	73	145	38	35	372	16	56
U C K	5040075	050400075	75	90	169	44	41	540	16	35
U C K	5040090	050400090	90	108	199	51	49	970	16	24
U C	5040110	050400110	110	129	239	61	59	1510	16	14
U	5040125	050400125	125	148	270	69	66	2234	16	9
U	5040140	050400140	140	162	298	76	73	2650	16	6
U	5040160	050400160	160	184	339	86	84	3793	10	3
	*5040200	*050400200	200	232	420	106	102	7200	10	2
	*5040225	*050400225	225	258	465	119	114	9700	10	1
	*5040250	*050400250	250	286	519	132.5	127	12070	10	1
	*5040280	*050400280	280	319	579	147.5	142	17480	10	1
	*5040315	*050400315	315	360	648	165	159	24350	10	1

Quality certifications : U= UNI-IIP, C= NF-CSTB, K = Kiwa

* DELIVERY PROGRAM

90° Elbow - Cemented

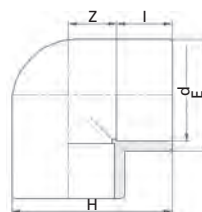

Cod MG
5050

Cod Plasson
050500

Quality	Cod MG	Cod Plasson	d	E	H	l	Z	Weight	PN	Pack
U C K	5050016	050500016	16	23	35	14	9	13	16	1800
U C K	5050020	050500020	20	25	41	16	12	21	16	1000
U C K	5050025	050500025	25	31	48	19	14	32	16	600
U C K	5050032	050500032	32	39	58	22	17	40	16	350
U C K	5050040	050500040	40	47	73	26	23	69	16	200
U C K	5050050	050500050	50	59	88	32	27	125	16	130
U C K	5050063	050500063	63	73	110	38	35	300	16	60
U C K	5050075	050500075	75	90	130	44	41	450	16	50
U C K	5050090	050500090	90	108	154	51	49	730	16	30
U C	5050110	050500110	110	132	186	61	59	1232	16	17
U	5050125	050500125	125	148	211	69	66	1668	16	12
U	5050140	050500140	140	162	230	76	73	1970	16	9
U	5050160	050500160	160	184	262	86	84	2850	16	5
	*5050200	*050500200	200	232	324	106	102	5850	10	3
	*5050225	*050500225	225	258	362	119	114	7500	10	2
	*5050250	*050500250	250	286	445	132	188	12150	10	1
	*5050280	*050500280	280	316	496	146	210	15620	10	1
	*5050315	*050500315	315	358	559	162	239	23500	10	1

Quality certifications : U= UNI-IIP, C= NF-CSTB, K = Kiwa

* DELIVERY PROGRAM

PVC CEMENTED FITTINGS

End Cap - Cemented

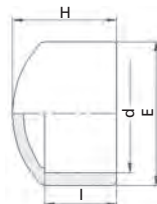

Cod MG
5070

Cod Plasson
050700

Quality	Cod MG	Cod Plasson	d	E	H	l	Weight	PN	Pack
U C K	5070016	050700016	16	21	20	14	5	16	3000
U C K	5070020	050700020	20	25	24	16	10	16	2500
U C K	5070025	050700025	25	30	28	19	16	16	1400
U C K	5070032	050700032	32	38	32	22	28	16	1000
U C K	5070040	050700040	40	48	42	26	51	16	500
U C K	5070050	050700050	50	58	47	31	60	16	320
U C K	5070063	050700063	63	73	57	38	106	16	150
U C K	5070075	050700075	75	88	63	44	179	16	75
U C K	5070090	050700090	90	104	73	51	270	16	45
U C	5070110	050700110	110	126	85	61	416	16	25
U	5070125	050700125	125	143	98	69	640	16	40
U	5070140	050700140	140	161	108	76	905	16	30
U	5070160	050700160	160	181	123	86	1160	16	20

Quality certifications : U= UNI-IIP, C= NF-CSTB, K = Kiwa

Union - Cemented

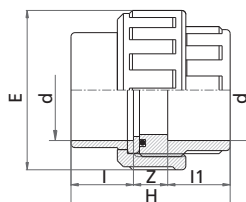

Cod MG
5080

Cod Plasson
050800

Cod MG	Cod Plasson	d	E	H	l	L1	Z	Weight	PN	Pack
5080016	050800016	16	34	39	14	14	11	9	16	1200
5080020	050800020	20	42	45	16	16	13	15	16	580
5080025	050800025	25	52	51	19	19	13	24	16	400
5080032	050800032	32	59	58	22	22	13	91	16	250
5080040	050800040	40	66	67	26	26	15	140	16	150
5080050	050800050	50	79	79	31	31	17	177	16	100
5080063	050800063	63	96	95	38	38	19	305	16	60
5080075	050800075	75	118	110	44	44	22	210	10	45
5080090	050800090	90	132	125	51	51	23	345	10	30
5080110	050800110	110	151	145	61	61	23	525	10	18

PVC CEMENTED FITTINGS

**Short Reducing
Bushing - Cemented**

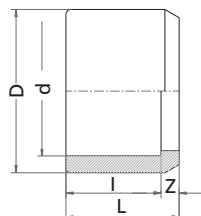
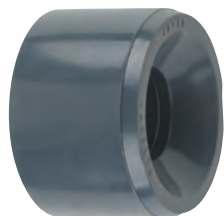

Cod MG
5090

Cod Plasson
050900

Quality	Cod MG	Cod Plasson	Dxd	L	l	z	Weight	PN	Pack
U C	5090020016	050900020016	20 x 16	16	14	2	3	16	4500
U	5090025016	050900025016	25 x 16	19	14	5	8	16	3000
U C	5090025020	050900025020	25 x 20	19	16	3	5	16	3000
U	5090032016	050900032016	32 x 16	22	14	8	15	16	1800
U	5090032020	050900032020	32 x 20	22	16	6	15	16	1800
U C	5090032025	050900032025	32 x 25	22	19	3	10	16	1800
U	5090040020	050900040020	40 x 20	26	16	10	25	16	1100
U	5090040025	050900040025	40 x 25	26	23	6	27	16	1000
U C	5090040032	050900040032	40 x 32	26	22	4	17	16	1000
U	5090050025	050900050025	50 x 25	31	19	12	43	16	550
U	5090050032	050900050032	50 x 32	31	22	9	50	16	550
U C	5090050040	050900050040	50 x 40	31	26	5	32	16	600
U	5090063032	050900063032	63 x 32	38	22	16	76	16	150
U	5090063040	050900063040	63 x 40	38	26	12	83	16	300
U C	5090063050	050900063050	63 x 50	38	34	6	60	16	300
U	5090075040	050900075040	75 x 40	44	26	18	121	16	126
U	5090075050	050900075050	75 x 50	44	31	13	95	16	126
U C	5090075063	050900075063	75 x 63	44	38	6	80	16	126
U	5090090050	050900090050	90 x 50	51	31	20	195	16	80
U	5090090063	050900090063	90 x 63	51	38	13	183	16	80
U C	5090090075	050900090075	90 x 75	51	44	7	141	16	80
U	5090110063	050900110063	110 x 63	61	38	23	344	16	40
U	5090110075	050900110075	110 x 75	61	44	17	315	16	40
U C	5090110090	050900110090	110 x 90	61	51	10	265	16	40
U	5090125075	050900125075	125 x 75	69	44	25	450	16	60
U	5090125090	050900125090	125 x 90	69	51	18	430	16	60
U	5090125110	050900125110	125 x 110	69	61	8	265	16	60
	5090140090	050900140090	140 x 90	76	51	25	590	16	48
	5090140110	050900140110	140 x 110	76	61	15	447	16	48
	5090140125	050900140125	140 x 125	76	69	7	326	16	48
	5090160110	050900160110	160 x 110	86	61	25	775	16	30
	5090160125	050900160125	160 x 125	86	69	17	725	16	30
	5090160140	050900160140	160 x 140	86	76	10	560	16	36
	5090200160	050900200160	200 x 160	106	86	20	1400	10	15
	5090200180	050900200180	200 x 180	106	96	22	1350	10	10
	5090225160	050900225160	225 x 160	119	86	33	2450	10	10
	5090225200	050900225200	225 x 200	119	106	13	1406	10	10
	*5090250160	*050900250160	250 x 160	134	87	47	2184	10	8
	*5090250200	*050900250200	250 x 200	134	107	27	2700	10	8
	*5090250225	*050900250225	250 x 225	132	120	12	2100	10	6
	*5090280225	*050900280225	280 x 225	147	120	27	3090	10	6
	*5090280250	*050900280250	280 x 250	147	132	15	2520	10	6
	*5090315200	*050900315200	315 x 200	165	107	58	8550	10	4
	*5090315225	*050900315225	315 x 225	165	132	33	8085	10	4
	*5090315250	*050900315250	315 x 250	165	132	33	4100	10	4
	*5090315280	*050900315280	315 x 280	165	149	16	4630	10	4

Quality certifications : U = UNI-IIP, C = NF-CSTB

* DELIVERY PROGRAM

PVC CEMENTED FITTINGS

90° Reducing Tee Cemented

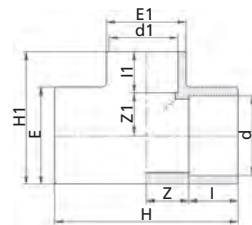

Cod MG
5140

Cod Plasson
051400

Cod MG	Cod Plasson	dxd1xd	E	E1	I	I1	Z	Z1	H	H1	Weight	PN	Pack
5140025020	051400025020	25 x 20 x 25	33	27	19	16	14	12.5	66	45	36	16	500
5140032020	051400032020	32 x 20 x 32	42	33	22	16	17	27.5	78	54	69	16	300
5140032025	051400032025	32 x 25 x 32	41	33	22	19	17	17.5	78	57	63	16	300
5140040020	051400040020	40 x 20 x 40	50	30	26	16	23.5	22	99	63	104	16	180
5140040025	051400040025	40 x 25 x 40	50	37	26	24	23.5	22	99	66	110	16	160
5140040032	051400040032	40 x 32 x 40	50	44	26	22	23.5	22	99	72	120	16	150
5140050025	051400050025	50 x 25 x 50	62	37	31	24	28	27.5	118	77	188	16	80
5140050032	051400050032	50 x 32 x 50	61	41	31	22	28	27.5	118	80	190	16	80
5140050040	051400050040	50 x 40 x 50	61	50	31	26	28	27.5	118	84	180	16	80
5140063032	051400063032	63 x 32 x 63	77	41	38	22	34	34.5	144	95	335	16	56
5140063040	051400063040	63 x 40 x 63	77	50	38	26	34	34.5	144	99	340	16	56
5140063050	051400063050	63 x 50 x 63	77	61	38	31	34	34.5	144	104	350	16	56

Hose Adaptor Cemented

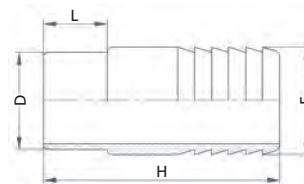

Cod MG
5360

Cod Plasson
053600

Cod MG	Cod Plasson	d	E	H	L	Weight	PN	Pack
5360012	053600012	12	12	48	10	4	16	7200
5360016	053600016	16	16	58	14	8	16	3600
5360020	053600020	20	20	65	17	15	16	2000
5360025	053600025	25	25	75	19	26	16	1200
5360032	053600032	32	30	88	22	33	16	600
5360040	053600040	40	40	95	26	60	16	320
5360050	053600050	50	50	102	31	120	16	200
5360063	053600063	63	60	118	38	163	16	120

PVC CEMENTED FITTINGS

45° Elbow - Cemented

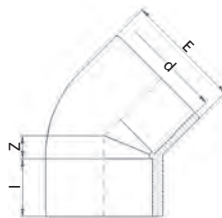

Cod MG
5450

Cod Plasson
054500

Quality	Cod MG	Cod Plasson	d	E	Z	l	Weight	PN	Pack
U C K	5450016	054500016	16	23	5	14	11	16	1800
U C K	5450020	054500020	20	26	5	16	12	16	1400
U C K	5450025	054500025	25	31	6	19	20	16	850
U C K	5450032	054500032	32	39	8	22	32	16	450
U C K	5450040	054500040	40	50,4	10	26,8	69	16	250
U C K	5450050	054500050	50	60	12	31,9	106	16	120
U C K	5450063	054500063	63	74,9	15	39	193	16	80
U C K	5450075	054500075	75	91	17	44	366	16	65
U C K	5450090	054500090	90	109	21	51	567	16	35
U C	5450110	054500110	110	129	25	61	850	16	21
U	5450125	054500125	125	148	28	69	1320	16	14
U	5450140	054500140	140	163	31	76	1620	16	12
U	5450160	054500160	160	184	35	86	2180	16	6
	*5450200	*054500200	200	232	45	106	5000	10	3
	*5450225	*054500225	225	258	50	119	6200	10	2
	*5450250	*054500250	250	287	58	131,5	7680	10	2
	*5450280	*054500280	280	320	62	147	10350	10	1
	*5450315	*054500315	315	360	66	165	14480	10	1

Quality certifications : U= UNI-IIP, C= NF-CSTB, K = Kiwa

* DELIVERY PROGRAM

Flange Adaptor with O-Ring Cemented

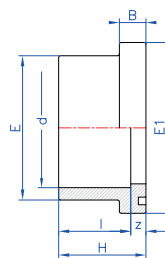

Cod MG
5500

Cod Plasson
055000

Quality	Cod MG	Cod Plasson	d	E	E1	l	Z	B	H	Weight	PN	Pack
U	5500020	055000020	20	27	34	16	6	10	22	12	16	2000
U	5500025	055000025	25	33	41	19	6	10	25	18	16	1200
U	5500032	055000032	32	41	50	22	6	10	28	27	16	850
U	5500040	055000040	40	50	61	26	8	13	34	55	16	400
U	5500050	055000050	50	61	73	31	8	13	39	70	16	270
U	5500063	055000063	63	76	90	38	8	14	46	120	16	160
U	5500075	055000075	75	88	106	44	8	15	53	175	16	135
U	5500090	055000090	90	105	125	51	10	16	61	270	16	75
U	5500110	055000110	110	126	150	61	11	18	72	420	16	48
U	5500125	055000125	125	146	169	69	11	17	80	670	16	40
U	5500140	055000140	140	163	188	76	12	18	88	860	16	21
U	5500160	055000160	160	185	213	86	12	19	98	1140	16	16
	5500200	055000200	200	228	254	106	13	23	119	1300	10	8
	5500225	055000225	225	249	272	119	14	25	133	1500	10	6

Quality certifications : U = UNI-IIP

PVC CEMENTED FITTINGS

Stub Flat Face to fit Cemented

Cod MG
5510

Cod Plasson
055100

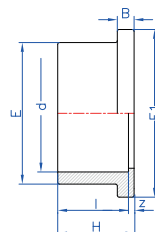
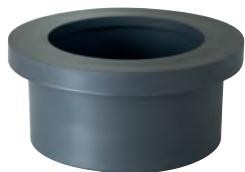

MG: 5500

PLASSON: 055000

Quality	Cod MG	Cod Plasson	d	E	E1	I	Z	B	H	Weight	PN	Pack
U	5510020	055100020	20	27	34	16	3	7	19	10	16	2000
U	5510025	055100025	25	33	41	19	3	7	22	16	16	1200
U	5510032	055100032	32	41	50	22	3	7	25	25	16	850
U	5510040	055100040	40	50	61	26	3	8	29	40	16	400
U	5510050	055100050	50	61	73	31	3	8	34	60	16	270
U	5510063	055100063	63	76	90	38	3	9	41	100	16	160
U	5510075	055100075	75	88	106	44	4	10	48	150	16	135
U	5510090	055100090	90	105	125	51	5	11	56	240	16	75
U	5510110	055100110	110	126	150	61	5	12	66	370	16	48
U	5510125	055100125	125	146	169	69	5	11	74	585	16	40
U	5510140	055100140	140	163	188	76	6	12	82	735	16	21
U	5510160	055100160	160	185	213	86	6	13	92	1000	16	16
	5510200	055100200	200	228	254	106	7	17	113	1655	10	8
	5510225	055100225	225	249	272	119	8	18	126	1805	10	6

Quality certifications : U = UNI-IIP

Stub Serrated Cemented

Cod MG
5520

Cod Plasson
055200



Quality	Cod MG	Cod Plasson	d	E	E1	I	Z	B	H	Weight	PN	Pack
U	5520020	055200020	20	27	34	16	3	7	19	10	16	2000
U	5520025	055200025	25	33	41	19	3	7	22	16	16	1200
U	5520032	055200032	32	41	50	22	3	7	25	25	16	850
U	5520040	055200040	40	50	61	26	3	8	29	40	16	400
U	5520050	055200050	50	61	73	31	3	8	34	60	16	270
U	5520063	055200063	63	76	90	38	3	9	41	100	16	160
U	5520075	055200075	75	88	106	44	4	10	48	150	16	135
U	5520090	055200090	90	105	125	51	5	11	56	240	16	75
U	5520110	055200110	110	126	150	61	5	12	66	380	16	48
U	5520125	055200125	125	146	169	69	5	11	74	590	16	40
U	5520140	055200140	140	163	188	76	6	12	82	735	16	21
U	5520160	055200160	160	185	213	86	6	13	92	1000	16	16
	5520200	055200200	200	228	254	106	7	19	114	1677	10	8
	5520225	055200225	225	249	272	119	8	18	126	1810	10	6
	*5520250	*055200250	250	273	307	131	10	20	131	2320	10	4
	*5520280	*055200280	280	308	329	142	10	23	142	3036	10	5
	*5520315	*055200315	315	346	379	161	11	27	161	4578	10	3

Quality certifications : U = UNI-IIP

* DELIVERY PROGRAM

PVC CEMENTED FITTINGS

Loose Flange

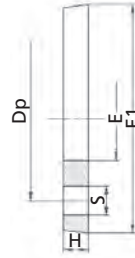

Cod MG
5900

Cod Plasson
059000

Quality	Cod MG	Cod Plasson	d	E	E1	H	Dp	S	N	Weight	PN	Pack
	*5900020	*059000020	20	28	95	12	65	14	4	85	16	450
	*5900025	*059000025	25	34	105	12	75	14	4	120	16	400
U	5900032	059000032	32	44	115	14	85	14	4	130	16	180
U	5900040	059000040	40	54	140	15	100	18	4	205	16	100
U	5900050	059000050	50	65	150	16	110	18	4	235	16	80
U	5900063	059000063	63	80	165	18	125	18	4	300	16	75
U	5900075	059000075	75	94	185	19	145	18	4	390	16	50
U	5900090	059000090	90	112	200	20	160	18	8	460	16	40
U	5900110	059000110	110	135	220	22	180	18	8	540	16	30
U	5900125	059000125	125	151	230	25	191	18	8	585	16	30
U	5900140	059000140	140	164	250	28	211	18	8	746	16	20
U	5900160	059000160	160	193	289	30	241	22	8	1050	16	18
	5900200	059000200	200	233	340	32	292	22	8	1402	10	12
	5900225	059000225	225	240	340	32	292	22	8	1249	10	12
	*5900250	*059000250	250	280	395	34	350	34	12	1680	10	8
	*5900280	*059000280	280	310	395	30	350	30	12	2000	10	8
	*5900315	*059000315	315	349	445	31	400	31	12	2700	10	8

Quality certifications : U = UNI-IIP

* DELIVERY PROGRAM

Blind Flange

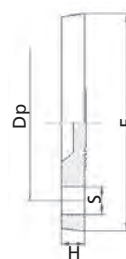

Cod MG
5910

Cod Plasson
059100

Cod MG	Cod Plasson	d	E	H	Dp	S	N	Weight	PN	Pack
5910032	059100032	32	115	14	85	14	4	143	16	100
5910040	059100040	40	140	15	100	18	4	240	16	100
5910050	059100050	50	150	16	110	18	4	286	16	80
5910063	059100063	63	165	18	125	18	4	390	16	75
5910075	059100075	75	185	19	145	18	4	490	16	50
5910090	059100090	90	200	20	160	18	8	640	16	40
5910110	059100110	110	220	22	180	18	8	786	16	30
5910125	059100125	125	230	25	191	18	8	848	16	25
5910140	059100140	140	250	28	211	18	8	1125	16	20
5910160	059100160	160	289	30	241	22	8	1743	16	15
5910200	059100200	200	340	32	292	22	8	2700	10	12
5910225	059100225	225	340	32	292	22	8	2950	10	12

PVC CEMENTED FITTINGS

Fixed Flange

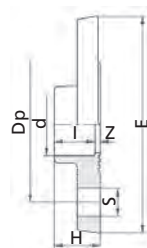

Cod MG
5920

Cod Plasson
059200

Quality	Cod MG	Cod Plasson	d	l	E	H	Dp	S	N	Z	Weight	PN	Pack
U	5920032	059200032	32	22	115	23	85	14	4	3	140	16	144
U	5920040	059200040	40	26	140	27	100	18	4	3	240	16	70
U	5920050	059200050	50	31	150	32	110	18	4	3	290	16	60
U	5920063	059200063	63	38	165	39	125	18	4	3	400	16	45
U	5920075	059200075	75	44	185	47	145	18	4	4	540	16	25
U	5920090	059200090	90	51	200	54	160	18	8	5	710	16	18
U	5920110	059200110	110	61	220	64	180	18	8	6	940	16	12

Quality certifications : U = UNI-IIP

PVC ADAPTOR FITTINGS

**Socket Adaptor
Cemented Threaded**

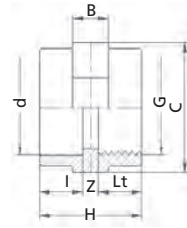

Cod MG **5012** Cod Plasson **050102**

Cod MG	Cod Plasson	dxG	C	B	I	Lt	Z	H	Weight	PN	Pack
5012016	050102016003	16 x 3/8"	25	12	14	13	3	30	10	16	2300
5012020	050102020005	20 x 1/2"	30	12	16	17	3	36	18	16	1400
5012025	050102025007	25 x 3/4"	40	12	19	18	3	40	27	16	900
5012032	050102032010	32 x 1"	45	12	22	20	3	45	42	16	500
5012040	050102040013	40 x 1.1/4"	51	16	26	22	4	52	50	16	300
5012050	050102050015	50 x 1.1/2"	63	16	31	22	4	57	100	16	200
5012063	050102063020	63 x 2"	80	16	38	26	4	68	150	16	100
5012075	050102075025	75 x 2.1/2"	90	20	44	29	5	78	190	16	60
5012090	050102090030	90 x 3"	108	24	51	33	5	89	333	16	60
5012110	050102110040	110 x 4"	130	28	61	40	5	106	483	16	32

**Reducer Adaptor
Male - Female
Cemented Threaded**

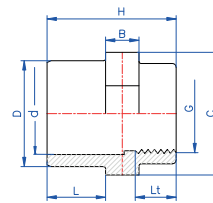

Cod MG **5022** Cod Plasson **050202**

Cod MG	Cod Plasson	DxdxG	C	B	L	Lt	H	Weight	PN	Pack
5022025005	050202025005	25 x 20 x 1/2"	30	12	19	17	46	19	16	1200
5022032007	050202032007	32 x 25 x 3/4"	36	12	22	18	50	30	16	700
5022040010	050202040010	40 x 32 x 1"	47	16	26	20	63	60	16	350
5022050013	050202050013	50 x 40 x 1.1/4"	65	16	31	22	68	111	16	200
5022063013	050202063013	63 x 50 x 1.1/4"	65	16	38	22	75	135	16	150
5022063015	050202063015	63 x 50 x 1.1/2"	65	16	38	22	75	135	16	150
5022075020	050202075020	75 x 63 x 2"	80	20	44	26	83	180	16	120
5022090025	050202090025	90 x 75 x 2.1/2"	95	20	51	29	94	268	16	80
5022110030	050202110030	110 x 90 x 3"	120	20	61	33	106	468	16	50

**Adaptor Socket
Male - Female
Cemented Threaded**

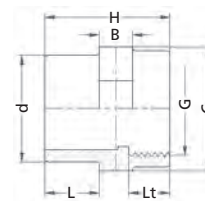

Cod MG **5032** Cod Plasson **050302**

Cod MG	Cod Plasson	dxG	C	B	L	Lt	H	Weight	PN	Pack
5032025	050302025007	25 x 3/4"	30	12	19	18	46	24	16	700
5032032	050302032010	32 x 1"	36	12	22	20	51	46	16	500
5032040	050302040013	40 x 1.1/4"	50	16	26	19	60	60	16	300
5032050	050302050015	50 x 1.1/2"	63	16	32	21	69	109	16	200
5032063	050302063020	63 x 2"	65	16	38	26	73	148	16	100
5032075	050302075025	75 x 2.1/2"	80	20	44	29	87	180	16	90
5032090	050302090030	90 x 3"	95	20	51	33	97	328	16	50
5032110	050302110040	110 x 4"	120	20	61	40	112	478	16	30

PVC ADAPTOR FITTINGS

90° Tee
Cemented Threaded

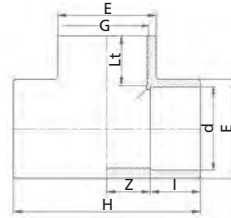

Cod MG
5042

Cod Plasson
050402

Cod MG	Cod Plasson	dxGxd	E	I	Lt	Z	H	Weight	PN	Pack
5042016	050402016003	16 x 3/8"	22	14	13	9	46	16	16	1440
5042020	050402020005	20 x 1/2"	27	16	17	11	55	24	16	700
5042025	050402025007	25 x 3/4"	33	19	18	14	65	39	16	500
5042032	050402032010	32 x 1"	41	22	20	17	78	70	16	250
5042040	050402040013	40 x 1.1/4"	48	26	22	21	98	121	16	130
5042050	050402050015	50 x 1.1/2"	62	31	22	26	118	205	16	80
5042063	050402063020	63 x 2"	73	38	26	33	145	400	16	56
5042075	050402075025	75 x 2.1/2"	90	44	29	40	170	620	16	35
5042090	050402090030	90 x 3"	108	51	33	48	199	1006	16	24
5042110	050402110040	110 x 4"	132	61	40	58	229	1620	16	14

90° Elbow
Cemented Threaded

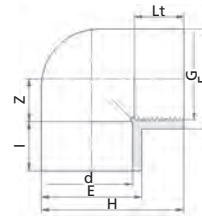

Cod MG
5052

Cod Plasson
050502

Cod MG	Cod Plasson	dxG	E	I	Lt	Z	H	Weight	PN	Pack
5052016	050502016003	16 x 3/8"	23	14	13	9	34	10	16	2000
5052020	050502020005	20 x 1/2"	20	16	17	11	41	15	16	1000
5052025	050502025007	25 x 3/4"	30	19	18	14	49	25	16	600
5052032	050502032010	32 x 1"	38	22	20	17	60	45	16	350
5052040	050502040013	40 x 1.1/4"	48	26	22	21	74	70	16	200
5052050	050502050015	50 x 1.1/2"	62	31	22	26	90	165	16	130
5052063	050502063020	63 x 2"	73	38	26	33	111	315	16	60
5052075	050502075025	75 x 2.1/2"	90	44	29	40	130	469	16	50
5052090	050502090030	90 x 3"	108	51	33	47	154	775	16	32
5052110	050502110040	110 x 4"	132	61	40	57	186	1230	16	17

Adaptor
Male - Female
Cemented - Male Threaded

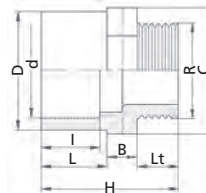

Cod MG
5062

Cod Plasson
050602

Cod MG	Cod Plasson	DxdxR	C	B	I	L	Lt	H	Weight	PN	Pack
5062003	050602016003	16 x 12 x 3/8"	22	12	12	14	11	37	10	16	2700
5062005	050602020005	20 x 16 x 1/2"	24	12	14	16	16	44	18	16	2000
5062007	050602025007	25 x 20 x 3/4"	30	12	16	19	17,43	49	18	16	1200
5062010	050602032010	32 x 25 x 1"	39	12	19	22	20	55,2	28	16	700
5062013	050602040013	40 x 32 x 1.1/4"	46	16	22	26	22	64	64	16	400
5062015	050602050015	50 x 40 x 1.1/2"	50	16	26	31	22	69	103	16	220
5062020	050602063020	63 x 50 x 2"	65	16	31	38	26	80	167	16	140
5062025	050602075025	75 x 63 x 2.1/2"	76	12	38	44	29	85	158	16	125
5062030	050602090030	90 x 75 x 3"	95	20	44	51	33	104	329	16	75
5062040	050602110040	110 x 90 x 4"	120	20	51	61	41	122	483	16	32
5062050	050602125050	125 x 110 x 5"	130	20	61	69	43	132	720	16	24

PVC ADAPTOR FITTINGS

Union Adaptor
Female - Cemented
Threaded

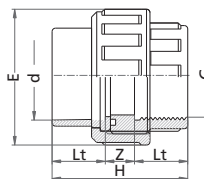

Cod MG **5082** Cod Plasson **050802**

Cod MG	Cod Plasson	dxG	E	I	Lt	Z	H	Weight	PN	Pack
5082016	050802016003	16 x 3/8"	34	14	13	13	39	22	16	1000
5082020	050802020005	20 x 1/2"	42	16	17	12	46	39	16	580
5082025	050802025007	25 x 3/4"	52	19	18	15	51	63	16	400
5082032	050802032010	32 x 1"	59	22	20	17	57	87	16	250
5082040	050802040013	40 x 1.1/4"	72	26	24	16	66	140	16	150
5082050	050802050015	50 x 1.1/2"	79	31	24	17	72	190	16	100
5082063	050802063020	63 x 2"	96	38	34	20	92	334	16	60
5082075	050802075025	75 x 2.1/2"	118	44	29	50	110	566	10	45
5082090	050802090030	90 x 3"	132	51	33	59	125	730	10	30
5082110	050802110040	110 x 4"	151	61	40	63	145	1213	10	18

Adaptor
Male - Female - Cemented
Male - Threaded

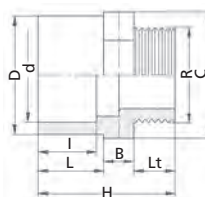

Cod MG **5212** Cod Plasson **052102**

Cod MG	Cod Plasson	DxdxR	C	B	I	L	Lt	H	Weight	PN	Pack
5212003	052102016003	20 x 16 x 3/8"	22	12	14	16	11	40	10	16	2500
5212005	052102020005	25 x 20 x 1/2"	28	12	16	19	17,3	49	16	16	1300
5212007	052102025007	32 x 25 x 3/4"	34	12	19	22	17,7	52	25	16	800
5212010	052102032010	40 x 32 x 1"	46,5	16	22	26	19	62	53	16	200
5212013	052102040013	50 x 40 x 1.1/4"	50	16	26	31	22	70	70	16	250
5212015	052102050015	63 x 50 x 1.1/2"	65	16	31	38	22	76	140	16	170
5212020	052102063020	75 x 63 x 2"	76	12	38	44	26	82	158	16	60
5212025	052102075025	90 x 75 x 2.1/2"	95	20	44	51	30	101	310	16	60
5212030	052102090030	110 x 90 x 3"	120	20	51	61	33	114	550	16	25
5212040	052102110040	125 x 110 x 4"	130	20	61	69	41	130	590	16	30

Bushing Adaptor
Male - Female - Cemented
Male - Threaded

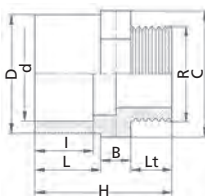

Cod MG **5222** Cod Plasson **052202**

Cod MG	Cod Plasson	DxdxR	C	B	I	L	L1	H	Weight	PN	Pack
5222003	052202020003	25 x 20 x 3/8"	30	12	16	19	11	42	15	16	1400
5222005	052202025005	32 x 25 x 1/2"	36	12	19	22	16	50	25	16	900
5222007	052202032007	40 x 32 x 3/4"	46	16	22	26	17	59	51	16	450
5222010	052202040010	50 x 40 x 1"	50	16	26	31	19	66	97	16	200
5222013	052202050013	63 x 50 x 1.1/4"	65	16	31	38	22	76	135	16	170
5222015	052202063015	75 x 63 x 1.1/2"	76	12	38	44	22	78	153	16	120
5222020	052202075020	90 x 75 x 2"	95	20	44	51	26	97	285	16	24
5222025	052202090025	110 x 90 x 2.1/2"	120	20	51	61	30	111	528	16	50
5222030	052202110030	125 x 110 x 3"	130	20	61	69	33	122	545	16	42

PVC ADAPTOR FITTINGS

**Hose Adaptor
With Threaded Nut**

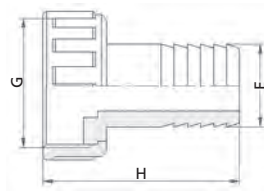

Cod MG
5362

Cod Plasson
053602

Cod MG	Cod Plasson	GxE	E	H	Weight	PN	Pack
5362007	053602016007	3/4" x 16	16	67	21	10	1000
5362010	053602020010	1" x 20	20	72	32	10	700
5362013	053602025013	1.1/4" x 25	25	80	54	10	400
5362015	053602030015	1.1/2" x 30	30	91	69	10	250
5362020	053602040020	2" x 40	40	97	124	10	150
5362023	053602050023	2.1/4" x 50	50	104	186	10	120
5362027	053602060027	2.3/4" x 60	60	118	260	10	70

**45° Elbow
Cemented - Threaded**

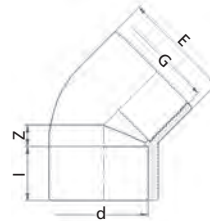

Cod MG
5452

Cod Plasson
054502

Cod MG	Cod Plasson	dxG	E	Z	l	Weight	PN	Pack
5452016	054502016003	16 x 3/8"	23	5	14	13	16	1800
5452020	054502020005	20 x 1/2"	26	5	16	15	16	1400
5452025	054502025007	25 x 3/4"	31	6	19	24	16	850
5452032	054502032010	32 x 1"	39	8	22	42	16	450
5452040	054502040013	40 x 1.1/4"	48	10	26	70	16	250
5452050	054502050015	50 x 1.1/2"	59	12	31	121	16	120
5452063	054502063020	63 x 2"	74	15	38	230	16	80

**90° Reducing Tee
Cemented - Threaded**

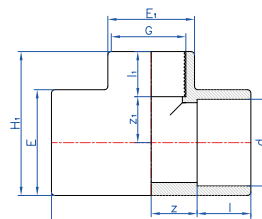

Cod MG
5142

Cod Plasson
051402

Cod MG	Cod Plasson	dxGxd	E	E1	l	l1	Z	Z1	H	H1	Weight	PN	Pack
5142025005	051402025005	25 x 1/2" x 25	33	28	19	16	14	12.5	66	45	36	16	500
5142032005	051402032005	32 x 1/2" x 32	42	30	22	16	17	27.5	78	54	69	16	300
5142032007	051402032007	32 x 3/4" x 32	41	33	22	19	17	17.5	78	57	63	16	300
5142040005	051402040005	40 x 1/2" x 40	50	30	26	16	23.5	22	99	63	104	16	180
5142040007	051402040007	40 x 3/4" x 40	50	37	26	24	23.5	22	99	66	110	16	160
5142040010	051402040010	40 x 1" x 40	50	44	26	22	23.5	22	99	72	120	16	150
5142050007	051402050007	50 x 3/4" x 50	62	37	31	24	28	27.5	118	77	188	16	80
5142050010	051402050010	50 x 1" x 50	61	41	31	22	28	27.5	118	80	190	16	80
5142050013	051402050013	50 x 1.1/4" x 50	61	50	31	26	28	27.5	118	84	180	16	80
5142063010	051402063010	63 x 1" x 63	77	41	38	22	34	34.5	144	95	335	16	56
5142063013	051402063013	63 x 1.1/4" x 63	77	50	38	26	34	34.5	144	99	340	16	56
5142063015	051402063015	63 x 1.1/2" x 63	77	61	38	31	34	34.5	144	104	350	16	56

PVC ADAPTOR FITTINGS

Socket Adaptor with Reinforcing Ring
Cemented - Threaded

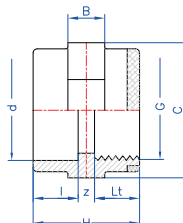

Cod MG **5712** Cod Plasson **057102**

Cod MG	Cod Plasson	dxG	C	B	I	Lt	Z	H	Weight	PN	Pack
5712016	057102016003	16 x 3/8"	25	12	14	13	3	30	10	16	2300
5712020	057102020005	20 x 1/2"	30	12	16	17	3	36	18	16	1400
5712025	057102025007	25 x 3/4"	40	12	19	18	3	40	27	16	900
5712032	057102032010	32 x 1"	45	12	22	20	3	45	42	16	500
5712040	057102040013	40 x 1.1/4"	51	16	26	22	4	52	50	16	300
5712050	057102050015	50 x 1.1/2"	63	16	31	22	4	57	100	16	200
5712063	057102063020	63 x 2"	80	16	38	26	4	68	150	16	100

Reducer Adaptor with Reinforcing Ring
Male - Cemented
Female - Threaded

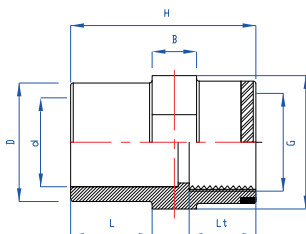
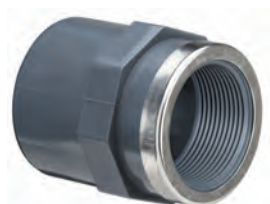

Cod MG **5722** Cod Plasson **057202**

Cod MG	Cod Plasson	DxdxG	C	B	L	Lt	H	Weight	PN	Pack
5722025005	057202025005	25 x 20 x 1/2"	30	12	19	17	46	19	16	1200
5722032007	057202032007	32 x 25 x 3/4"	36	12	22	18	50	30	16	700
5722040010	057202040010	40 x 32 x 1"	47	16	26	20	63	60	16	350
5722050013	057202050013	50 x 40 x 1.1/4"	65	16	31	22	68	111	16	200
5722063013	057202063013	63 x 50 x 1.1/4"	65	16	38	22	75	135	16	150
5722063015	057202063015	63 x 50 x 1.1/2"	65	16	38	22	75	135	16	150

PVC ADAPTOR FITTINGS

**90° Tee
with Reinforcing
Ring**
Cemented - Threaded

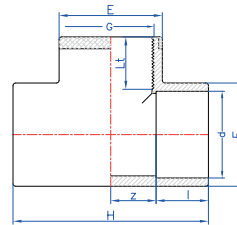

Cod MG **5742** Cod Plasson **057402**

Cod MG	Cod Plasson	dxGxd	E	I	Lt	Z	H	Weight	PN	Pack
5742016	057402016003	16 x 3/8"	22	14	13	9	46	16	16	1440
5742020	057402020005	20 x 1/2"	27	16	17	11	55	24	16	700
5742025	057402025007	25 x 3/4"	33	19	18	14	65	39	16	500
5742032	057402032010	32 x 1"	41	22	20	17	78	70	16	250
5742040	057402040013	40 x 1.1/4"	48	26	22	21	98	121	16	130
5742050	057402050015	50 x 1.1/2"	62	31	22	26	118	205	16	80
5742063	057402063020	63 x 2"	73	38	26	33	145	400	16	56

**90° Elbow
with Reinforcing
Ring**
Cemented - Threaded

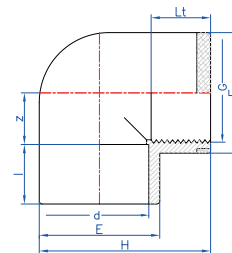

Cod MG **5752** Cod Plasson **057502**

Cod MG	Cod Plasson	dxG	E	I	Lt	Z	H	Weight	PN	Pack
5752016	057502016003	16 x 3/8"	23	14	13	9	34	10	16	2000
5752020	057502020005	20 x 1/2"	20	16	17	11	41	15	16	1000
5752025	057502025007	25 x 3/4"	30	19	18	14	49	25	16	600
5752032	057502032010	32 x 1"	38	22	20	17	60	45	16	350
5752040	057502040013	40 x 1.1/4"	48	26	22	21	74	70	16	200
5752050	057502050015	50 x 1.1/2"	62	31	22	26	90	165	16	130
5752063	057502063020	63 x 2"	73	38	26	33	111	315	16	60

PVC ADAPTOR FITTINGS

**Adaptor Socket
Reinforcing Ring**
Male - Female

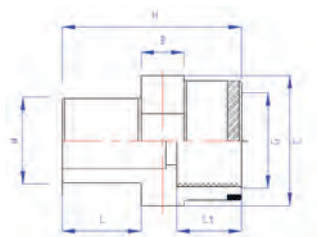

Cod MG
5732

Cod Plasson
057302

Cod MG	Cod Plasson	dxG	C	B	L	Lt	H	PFA (PN)	W
5732020	057302020005	20 x 1/2"	30	12	16	12	40	16	15
5732025	057302025007	25 x 3/4"	30	12	19	18	46	16	24
5732032	057302032010	32 x 1"	36	12	22	20	51	16	46
5732040	057302040013	40 x 1 1/4"	50	16	26	20	63	16	62
5732050	057302050015	50 x 1 1/2"	65	16	31	22	64	16	118
5732063	057302063020	63 x 2"	65	16	38	26	73	16	148

PVC THREADED FITTINGS

Socket - Threaded

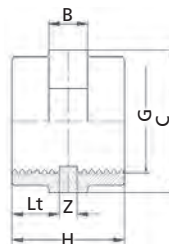

Cod MG
5011

Cod Plasson
050101

Cod MG	Cod Plasson	G	C	B	Lt	Z	H	Weight	PN	Pack
5011003	050101003	3/8"	25	12	13	4	30	10	16	2300
5011005	050101005	1/2"	30	12	17	2	36	16	16	1400
5011007	050101007	3/4"	40	12	18	4	40	28	16	900
5011010	050101010	1"	45	12	20	5	45	39	16	500
5011013	050101013	1.1/4"	51	16	22	8	52	55	16	300
5011015	050101015	1.1/2"	63	16	22	13	57	112	16	200
5011020	050101020	2"	80	16	26	16	68	166	16	100
5011025	050101025	2.1/2"	90	20	29	20	78	200	16	60
5011030	050101030	3"	108	24	33	23	89	310	16	60
5011040	050101040	4"	130	28	40	26	106	450	16	32

Reducing Socket Female - Female - Threaded

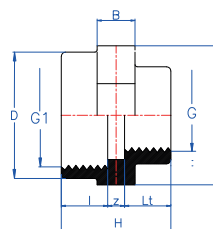

Cod MG
5013

Cod Plasson
050103

Cod MG	Cod Plasson	G1xG	C	B	I	Lt	Z	H	Weight	PN	Pack
5013007005	050103007005	3/4" x 1/2"	40	12	13	14	3	38,3	27	16	600
5013010007	050103010007	1" x 3/4"	45	12	14	17	3	42,21	37	16	500

PVC THREADED FITTINGS

Reducer Male - Female - Threaded

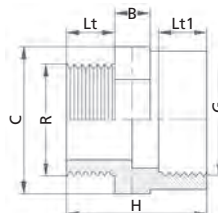

Cod MG
5021

Cod Plasson
050201

Cod MG	Cod Plasson	RXG	C	B	Lt	Lt1	H	Weight	PN	Pack
5021005003	050201005003	1/2" x 3/8"	30	12	13	17	40	17	16	800
5021007003	050201007003	3/4" x 3/8"	36	12	13	18	41	18	16	1400
5021007005	050201007005	3/4" x 1/2"	36	12	17	18	45	21	16	1100
5021010003	050201010003	1" x 3/8"	40	10	11	19	41	20	16	900
5021010005	050201010005	1" x 1/2"	40	12	22	11	46	33	16	900
5021010007	050201010007	1" x 3/4"	36	12	18	20	48	30	16	800
5021013005	050201013005	1.1/4" x 1/2"	46	16	17	22	53	52	16	450
5021013007	050201013007	1.1/4" x 3/4"	46	16	18	22	54	52	16	450
5021013010	050201013010	1.1/4" x 1"	55	16	24	22	58	71	16	350
5021015005	050201015005	1.1/2" x 1/2"	50	16	22	15	52	59	16	340
5021015007	050201015007	1.1/2" x 3/4"	50	16	18	22	54	61	16	340
5021015010	050201015010	1.1/2" x 1"	50	16	20	22	59	99	16	340
5021015013	050201015013	1.1/2" x 1.1/4"	55	16	23	24	58	74	16	300
5021020007	050201020007	2" x 3/4"	70	18	16	26	60	80	16	200
5021020010	050201020010	2" x 1"	65	16	20	26	62	105	16	200
5021020013	050201020013	2" x 1.1/4"	65	16	22	26	63	109	16	200
5021020015	050201020015	2" x 1.1/2"	65	16	22	26	63	109	16	200
5021025015	050201025015	2.1/2" x 1.1/2"	80	20	22	29	66	163	16	168
5021025020	050201025020	2.1/2" x 2"	80	20	26	29	68	170	16	80
5021030020	050201030020	3" x 2"	95	20	34	19	72	245	16	50
5021030025	050201030025	3" x 2.1/2"	95	20	29	33	76	254	16	40
5021040025	050201040025	4" x 2.1/2"	120	20	29	40	87	400	16	57
5021040030	050201040030	4" x 3"	120	20	42	25	86	406	16	25

90° Tee - Threaded

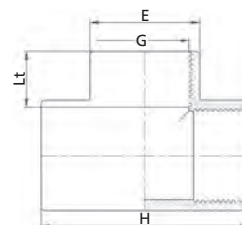

Cod MG
5041

Cod Plasson
050401

Cod MG	Cod Plasson	G	E	Lt	H	Weight	PN	Pack
5041003	050401003	3/8"	22	13	46	16	16	1500
5041005	050401005	1/2"	28	17	55	29	16	700
5041007	050401007	3/4"	33	18	65	40	16	500
5041010	050401010	1"	42	24	78	77	16	250
5041013	050401013	1.1/4"	48	22	98	120	16	130
5041015	050401015	1.1/2"	62	22	118	240	16	80
5041020	050401020	2"	73	26	145	480	16	56
5041025	050401025	2.1/2"	90	29	170	644	16	35
5041030	050401030	3"	108	33	199	1100	16	24
5041040	050401040	4"	132	40	239	1625	16	14

PVC THREADED FITTINGS

90° Elbow - Threaded

Cod MG
5051

Cod Plasson
050501

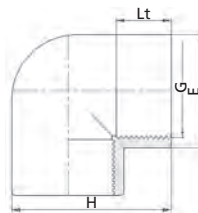

Cod MG	Cod Plasson	G	E	Lt	H	Weight	PN	Pack
5051003	050501003	3/8"	23	13	35	10	16	1800
5051005	050501005	1/2"	20	17	42	15	16	1000
5051007	050501007	3/4"	30	18	50	25	16	600
5051010	050501010	1"	38	20	60	45	16	350
5051013	050501013	1.1/4"	48	22	75	90	16	200
5051015	050501015	1.1/2"	62	22	90	180	16	130
5051020	050501020	2"	73	26	111	355	16	60
5051025	050501025	2.1/2"	90	29	130	508	16	50
5051030	050501030	3"	108	33	154	861	16	30
5051040	050501040	4"	132	40	186	1225	16	17

Nipple - Threaded

Cod MG
5061

Cod Plasson
050601

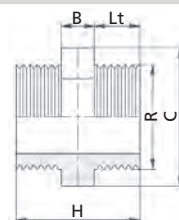

Cod MG	Cod Plasson	R	C	B	Lt	H	Weight	PN	Pack
5061003	050601003	3/8"	22	12	11	35	10	16	2800
5061005	050601005	1/2"	24	12	17	47	14	16	2000
5061007	050601007	3/4"	30	12	17	47	20	16	650
5061010	050601010	1"	34	12	20	52	30	16	700
5061013	050601013	1.1/4"	46	16	22	60	56	16	400
5061015	050601015	1.1/2"	50	16	22	60	65	16	300
5061020	050601020	2"	65	16	26	68	107	16	150
5061025	050601025	2.1/2"	80	20	30	80	190	16	96
5061030	050601030	3"	95	20	33	87	268	16	85
5061040	050601040	4"	120	20	41	102	520	16	42

Cap - Threaded

Cod MG
5071

Cod Plasson
050701

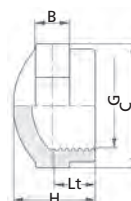

Cod MG	Cod Plasson	G	C	B	Lt	H	Weight	PN	Pack
5071003	050701003	3/8"	25	12	16	25	10	16	2600
5071005	050701005	1/2"	30	12	19	27	16	16	1400
5071007	050701007	3/4"	40	12	18	30	26	16	1100
5071010	050701010	1"	45	12	22	32	30	16	530
5071013	050701013	1.1/4"	52	12	22	33	42	16	300
5071015	050701015	1.1/2"	58	12	24	38	62	16	300
5071020	050701020	2"	75	12	22	45	117	16	160
5071025	050701025	2.1/2"	95	20	32	51	205	16	70
*5071025P	*050701025P	2.1/2"	95	20	32	51	205	16	70
5071030	050701030	3"	110	20	32	51	274	16	80
5071040	050701040	4"	130	20	35	63	453	16	56

* AVAILABLE IN BLACK PVC

PVC THREADED FITTINGS

Union Female Threaded

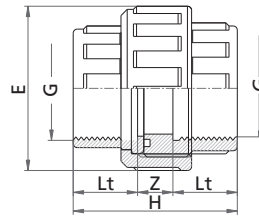

Cod MG
5081

Cod Plasson
050801

Cod MG	Cod Plasson	G	E	Lt	Z	H	Weight	PN	Pack
5081003	050801003	3/8"	34	13	13	39	22	16	1000
5081005	050801005	1/2"	42	17	12	46	49	16	580
5081007	050801007	3/4"	52	18	15	51	65	16	400
5081010	050801010	1"	59	20	17	57	90	16	250
5081013	050801013	1.1/4"	72	24	18	66	140	16	150
5081015	050801015	1.1/2"	79	24	24	72	190	16	100
5081020	050801020	2"	96	34	24	92	350	16	60
5081025	050801025	2.1/2"	118	30	50	110	570	10	45
5081030	050801030	3"	132	33	59	125	740	10	30
5081040	050801040	4"	151	41	63	145	1220	10	18

Union Male - Female Cemented - Threaded

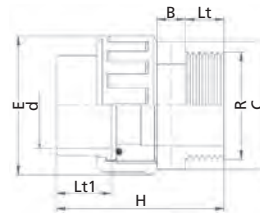

Cod MG
5083

Cod Plasson
050803

Cod MG	Cod Plasson	dxR	Lt	Lt1	E	H	C	B	Weight	PN	Pack
5083025	050803025007	25 x 3/4"	17	19	51	64,3	40	12	79	16	350
5083032	050803032010	32 x 1"	22	22	58	73,3	45	13	109	16	250
5083040	050803040013	40 x 1.1/4"	25	22	72	90	55	16	187	16	150
5083050	050803050015	50 x 1.1/2"	22	31	79	96	50	16	180	16	100
5083063	050803063020	63 x 2"	26	38	96	108	65	16	310	16	60

Union Male - Female Threaded

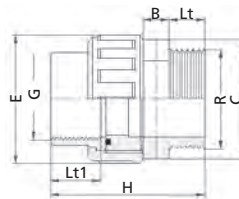

Cod MG
5084

Cod Plasson
050804

Cod MG	Cod Plasson	GxR	Lt	Lt1	E	H	C	B	Weight	PN	Pack
5084007	050804007	3/4" x 3/4"	17	19	51	64,3	40	12	79	16	350
5084010	050804010	1" x 1"	22	22	58	73,3	45	13	109	16	250
5084013	050804013	1.1/4" x 1.1/4"	22	22	72	89	46	16	135	16	150
5084015	050804015	1.1/2" x 1.1/2"	22	22	79	96	50	16	180	16	100
5084020	050804020	2" x 2"	26	26	96	104	65	16	310	16	60

PVC THREADED FITTINGS

Reducing Nipple Threaded

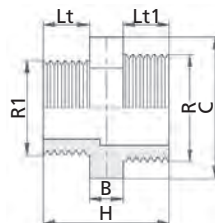

Cod MG
5161

Cod Plasson
051601

Cod MG	Cod Plasson	RxR1	C	B	Lt	Lt1	H	Weight	PN	Pack
5161005003	051601005003	1/2" x 3/8"	24	12	16	11	39	11	16	2200
5161007003	051601007003	3/4" x 3/8"	30	12	17	16	45	18	16	1400
5161007005	051601007005	3/4" x 1/2"	30	12	17	11	40	17	16	650
5161010005	051601010005	1" x 1/2"	38	12	19	17	46	27	16	900
5161010007	051601010007	1" x 3/4"	36	12	19	16	45	26	16	800
5161013007	051601013007	1.1/4" x 3/4"	50	16	22	19	57	57	16	400
5161013010	051601013010	1.1/4" x 1"	50	16	22	17	55	54	16	350
5161015010	051601015010	1.1/2" x 1"	50	16	22	22	56	59	16	350
5161015013	051601015013	1.1/2" x 1.1/4"	50	16	22	22	60	60	16	300
5161020013	051601020013	2" x 1.1/4"	65	16	26	22	64	104	16	200
5161020015	051601020015	2" x 1.1/2"	65	16	26	22	64	97	16	180
5161025015	051601025015	2.1/2" x 1.1/2"	80	20	30	22	72	170	16	164
5161025020	051601025020	2.1/2" x 2"	80	20	30	26	76	176	16	70
5161030020	051601030020	3" x 2"	90	20	33	30	83	265	16	75
5161030025	051601030025	3" x 2.1/2"	90	20	33	26	79	251	16	70
5161040025	051601040025	4" x 2.1/2"	120	20	41	33	94	435	16	70
5161040030	051601040030	4" x 3"	120	20	41	30	91	422	16	70

PVC THREADED FITTINGS

Plug - Threaded

Cod MG
5171

Cod Plasson
051701

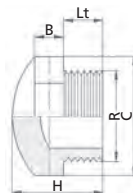

Cod MG	Cod Plasson	R	C	B	Lt	H	Weight	PN	Pack
5171003	051701003	3/8"	22	12	13	25	7	16	3000
5171005	051701005	1/2"	24	12	17	30	12	16	2500
5171007	051701007	3/4"	30	12	16	32	15	16	1500
5171010	051701010	1"	36	12	20	35	24	16	1100
5171013	051701013	1.1/4"	46	16	22	43	47	16	500
5171015	051701015	1.1/2"	51	16	22	44	57	16	480
5171020	051701020	2"	65	16	26	48	97	16	250
5171025	051701025	2.1/2"	80	20	30	56	160	16	82
5171030	051701030	3"	95	20	33	61	263	16	70
5171040	051701040	4"	120	20	40	71	425	16	72

Hose Adaptor Threaded

Cod MG
5361

Cod Plasson
053601

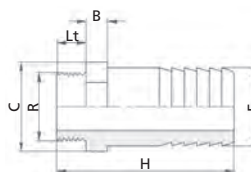

Cod MG	Cod Plasson	RxE	C	B	Lt	H	Weight	PN	Pack
5361001	053601012004	1/4" x 12	16	12	11	49	6	16	5600
5361003	053601016003	3/8" x 16	22	12	13	58	12	16	2200
5361005	053601020005	1/2" x 20	23	12	17	65	17	16	1600
5361007	053601025007	3/4" x 25	30	12	17	72	30	16	800
5361010	053601030010	1" x 30	36	16	19	84	38	16	560
5361013	053601040013	1.1/4" x 40	46	16	22	91	70	16	280
5361015	053601050015	1.1/2" x 50	50	16	22	94	107	16	200
5361020	053601060020	2" x 60	65	12	26	118	152	16	120
5361025	053601080025	2.1/2" x 80	80	19	29	110	236	16	90

Nipple Socket Male - Female - Threaded

Cod MG
5221

Cod Plasson
052201

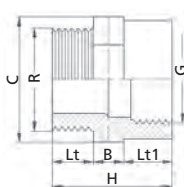

Cod MG	Cod Plasson	RxG	C	B	Lt	Lt1	H	Weight	PN	Pack
5221003005	052201003005	3/8" x 1/2"	30	12	17	11	40	18	16	1100
5221005007	052201005007	1/2" x 3/4"	36	12	18	16	44	25	16	900
5221007010	052201007010	3/4" x 1"	46	16	20	17	45	40	16	600
5221010013	052201010013	1" x 1.1/4"	55	16	22	18	57	68	16	300
5221013015	052201013015	1.1/4" x 1.1/2"	65	16	24	20	61	109	16	250
5221015020	052201015020	1.1/2" x 2"	80	16	26	24	66	169	16	150
5221015025	052201015025	1.1/2" x 2.1/2"	80	20	29	22	65	200	16	170
5221020025	052201020025	2" x 2.1/2"	95	20	29	26	69	210	16	170
5221020030	052201020030	2" x 3"	95	20	33	26	70	320	16	85
5221025030	052201025030	2.1/2" x 3"	120	20	33	30	74	340	16	70
5221025040	052201025040	2.1/2" x 4"	120	20	40	30	82	410	16	70
5221030040	052201030040	3" x 4"	130	20	40	33	87	430	16	70

PVC THREADED FITTINGS

**45° Elbow
Threaded**

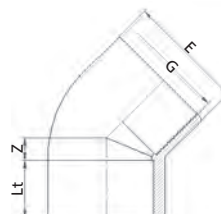

Cod MG
5451

Cod Plasson
54501

Cod MG	Cod Plasson	G	E	Z	Lt	Weight	PN	Pack
5451003	054501003	3/8"	23	5	14	13	16	1800
5451005	054501005	1/2"	26	5	17	15	16	1400
5451007	054501007	3/4"	31	6	18	24	16	850
5451010	054501010	1"	39	8	20	42	16	450
5451013	054501013	1.1/4"	48	10	22	70	16	250
5451015	054501015	1.1/2"	59	12	22	121	16	120
5451020	054501020	2"	74	15	26	230	16	80

**Fixed Flange
Threaded**

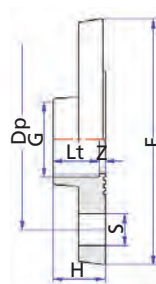

Cod MG
5921

Cod Plasson
059201

Cod MG	Cod Plasson	G	Lt	E	H	Dp	S	N	Z	Weight	PN	Pack
5921010	059201010	1"	20	115	23	85	14	4	3	148	16	144
5921013	059201013	1.1/4"	22	140	27	100	18	4	5	225	16	70
5921015	059201015	1.1/2"	22	150	32	110	18	4	10	276	16	60
5921020	059201020	2"	26	165	39	125	18	4	13	380	16	45
5921025	059201025	2.1/2"	29	185	47	145	18	4	18	659	16	25
5921030	059201030	3"	33	200	54	160	18	8	21	670	16	18
5921040	059201040	4"	40	220	64	180	18	8	24	900	16	12

PVC FITTINGS ACCESSORIES

Nut for Unions:

Cod MG
5480

Cod Plasson
054800

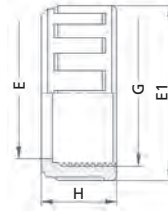

MG: 5080, 5081, 5082, 5083, 5084, 5362

PLASSON: 050800, 050801, 050802, 050803, 050804, 053602

Cod MG	Cod Plasson	Ø	G	E	E1	H	Weight	PN
5480016	054800016	16	3/4"	22	34	20	10	16
5480020	054800020	20	1"	27	42	23	18	16
5480025	054800025	25	1.1/4"	36	52	25	27	16
5480032	054800032	32	1.1/2"	41	59	27	35	16
5480040	054800040	40	2"	53	72	30	53	16
5480050	054800050	50	2.1/4"	57	79	34	70	16
5480063	054800063	63	2.3/4"	74	96	38	110	16
5480075	054800075	75	3.1/2"	93	118	46	190	10
5480090	054800090	90	4"	107	132	53	250	10
5480110	054800110	110	5"	125	151	59	430	10

Bushing for Union:

Cod MG
5580

Cod Plasson
055800

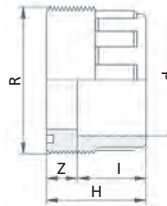

MG: 5080

PLASSON: 055800

Cod MG	Cod Plasson	d	R	I	Z	H	Weight	PN
5580016	055800016	16	3/4"	14	9	23	10	16
5580020	055800020	20	1"	16	10	26	14	16
5580025	055800025	25	1.1/4"	19	10	29	20	16
5580032	055800032	32	1.1/2"	22	10	32	34	16
5580040	055800040	40	2"	26	12	38	61	16
5580050	055800050	50	2.1/4"	31	14	45	81	16
5580063	055800063	63	2.3/4"	38	14	52	132	16
5580075	055800075	75	3.1/2"	44	18	62	205	10
5580090	055800090	90	4"	51	18	69	296	10
5580110	055800110	110	5"	61	18	79	473	10

Bushing for Unions:

Cod MG
5581

Cod Plasson
055801

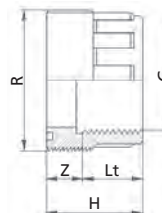

MG: 5081, 5082

PLASSON: 050801, 050802

Cod MG	Cod Plasson	G	R	Lt	Z	H	Weight	PN
5581003	055801003	3/8"	3/4"	13	9	23	10	16
5581005	055801005	1/2"	1"	17	10	26	17	16
5581007	055801007	3/4"	1.1/4"	18	11	29	24	16
5581010	055801010	1"	1.1/2"	20	12	32	34	16
5581013	055801013	1.1/4"	2"	22	16	38	65	16
5581015	055801015	1.1/2"	2.1/4"	22	23	45	95	16
5581020	055801020	2"	2.3/4"	26	26	52	170	16
5581025	055801025	2.1/2"	3.1/2"	29	33	62	241	10
5581030	055801030	3"	4"	33	36	69	300	10
5581040	055801040	4"	5"	40	39	79	475	10

PVC FITTINGS ACCESSORIES

Male Threaded Union bush for items

Cod MG
5583

Cod Plasson
055803

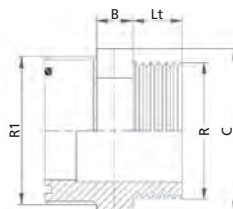

MG: 5083, 5084

PLASSON: 050803, 050804

Cod MG	Cod Plasson	R	R1	Lt	C	B	Weight	PN
5583007	055803007	3/4"	1.1/4"	17	40	12	36	16
5583010	055803010	1"	1.1/2"	19	46	12	50	16
5583013	055803013	1.1/4"	2"	22	46	16	61	16
5583015	055803015	1.1/2"	2.1/4"	22	50	16	81	16
5583020	055803020	2"	2.3/4"	26	65	16	132	16

End for Unions:

Cod MG
5680

Cod Plasson
056800

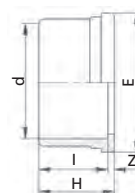

MG: 5080, 5082, 5083

PLASSON: 050800, 050802, 050803

Cod MG	Cod Plasson	d	l	Z	E	H	Weight	PN
5680016	056800016	16	14	2	24	16	10	16
5680020	056800020	20	16	3	30	19	14	16
5680025	056800025	25	19	3	39	22	20	16
5680032	056800032	32	22	3	44	25	34	16
5680040	056800040	40	26	3	55	29	61	16
5680050	056800050	50	31	3	62	34	81	16
5680063	056800063	63	38	3	78	41	132	16
5680075	056800075	75	44	4	97	48	205	10
5680090	056800090	90	51	5	110	56	296	10
5680110	056800110	110	61	5	135	66	473	10

End for Unions:

Cod MG
5681

Cod Plasson
056801

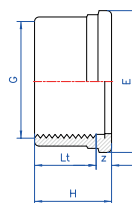

MG: 5081, 5084

PLASSON: 050801, 050804

Cod MG	Cod Plasson	G	Lt	Z	E	H	Weight	PN
5681003	056801003	3/8"	13	3	24	16	5	16
5681005	056801005	1/2"	17	3	30	20	10	16
5681007	056801007	3/4"	18	4	39	22	16	16
5681010	056801010	1"	20	5	44	25	23	16
5681013	056801013	1.1/4"	22	7	55	29	36	16
5681015	056801015	1.1/2"	22	12	62	34	60	16
5681020	056801020	2"	26	15	78	41	105	16
5681025	056801025	2.1/2"	29	19	97	48	135	10
5681030	056801030	3"	33	23	110	56	180	10
5681040	056801040	4"	40	26	135	66	310	10

PVC FITTINGS ACCESSORIES

O-Ring for Item:

MG - 5500

PLASSON - 055000

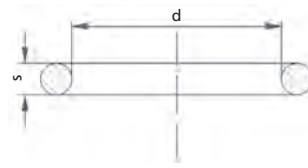

Cod MG
5609

Cod Plasson
05609

Cod MG	Cod Plasson	∅	d	s
5609025	05609025	25	28,17	3,53
5609032	05609032	32	36,1	3,53
5609040	05609040	40	40,65	5,34
5609050	05609050	50	50,16	5,34
5609063	05609063	63	66,04	5,34
6325	05609075	75	81,92	5,34
5609090	05609090	90	100,97	5,34
5609110	05609110	110	116,84	6,99
5609125	05609125	125	135,9	6,99
5609140	05609140	140	151,77	6,99
5609160	05609160	160	177,17	6,99
5609200	05609200	200	215,27	6,99
5609225	05609225	225	240,67	6,99

Seal for Item:

MG - 5520, 5362

PLASSON - 055200, 053602

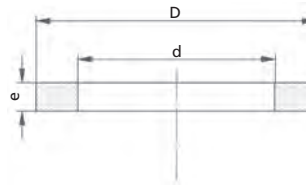

Cod MG
5629

Cod Plasson
05629

Cod MG	Cod Plasson	∅	d	D	e
5629016	05629016	16	17	24	2
5629020	05629020	20	21	30	2
5690025	05629025	25	27	38	2
5629032	05629032	32	32	44	2
5629040	05629040	40	42	55	2
5629050	05629050	50	46	62	2
5629063	05629063	63	63	88	2
5629075	05629075	75	75	104	2
5629090	05629090	90	90	123	2
5629110	05629110	110	110	148	3
5629125	05629125	125	125	166	3
5629140	05629140	140	140	186	3
5629160	05629160	160	160	211	3
5629200	05629200	200	200	245	3
5629225	05629225	225	225	270	3

PVC FITTINGS ACCESSORIES

O-Ring for Unions:

MG - 5080, 5081, 5082, 5083, 5084

PLASSON - 050800, 050801, 050802, 050803, 050804

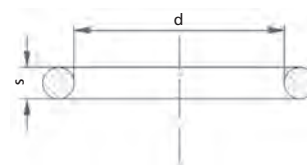

Cod MG
O-R

Cod Plasson
056390

Cod MG	Cod Plasson	Ø	d	s
121	05639016	16 - 3/8"	16	2,62
4081	05639020	20 - 1/2"	19	3,53
569025	05639025	25 - 3/4"	27	3,53
4118	05639032	32 - 1"	30	3,53
569040	05639040	40 - 1.1/4"	44	3,53
569050	05639050	50 - 1.1/2"	50	3,53
6237	05639063	63 - 2"	59.7	5,34
*569063	*05639063	63 - 2"	60	3,53
569075	05639075	75 - 2.1/2"	72	5,34
569090	05639090	90 - 3"	91	5,34
569110	05639110	110 - 4"	100	5,34

* O-Ring for Unions: 5083, 5084, 050803, 050804

VALVES Normal Support

Two Nut Valve Cemented

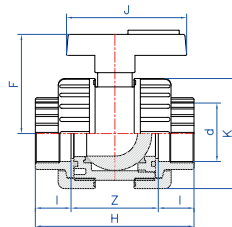

Cod MG
1150

Cod Plasson
11150

Cod MG	Cod Plasson	d	I	Z	H	F	J	K	DN	Weight	PN	Pack
1150016	11150016	16	14	43	71	45	65	45	10	93	16	160
1150020	11150020	20	16	43	75	45	65	45	15	103	16	160
1150025	11150025	25	19	51	89	54	73	55	20	201	16	90
1150032	11150032	32	22	58	102	66	78	66	25	281	16	50
1150040	11150040	40	26	68	120	74	96	80	32	475	16	40
1150050	11150050	50	31	80	142	86	110	96	40	672	16	28
1150063	11150063	63	38	93	169	106	129	118	50	1434	16	13

Two Nut Valve Threaded

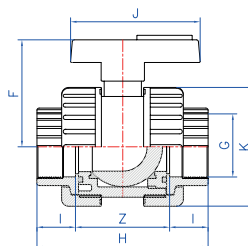

Cod MG
1151

Cod Plasson
11151

Cod MG	Cod Plasson	G	Lt	Z	H	F	J	K	DN	Weight	PN	Pack
1151003	11151003	3/8"	12	47	71	45	65	45	10	95	16	160
1151005	11151005	1/2"	15	45	75	45	65	45	15	105	16	160
1151007	11151007	3/4"	16	57	89	54	73	55	20	204	16	90
1151010	11151010	1"	19	64	102	66	78	66	25	284	16	50
1151013	11151013	1.1/4"	22	76	120	74	96	80	32	479	16	40
1151015	11151015	1.1/2"	22	98	142	86	110	96	40	681	16	28
1151020	11151020	2"	26	117	169	106	129	118	50	1439	16	13

VALVES
Normal Support

One Nut Valve
Cemented

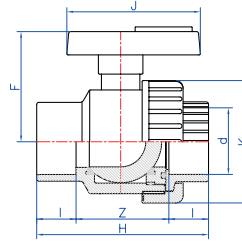

Cod MG
1350

Cod Plasson
11350

Cod MG	Cod Plasson	d	DN	I	Z	J	H	F	K	Weight	PN	Pack
1350016	11350016	16	10	14	41	69	45	65	45	85	16	200
1350020	11350020	20	15	16	41	73	45	65	45	90	16	200
1350025	11350025	25	20	19	49	87	54	73	55	159	16	110
1350032	11350032	32	25	22	55	99	66	78	66	222	16	60
1350040	11350040	40	32	26	64	116	74	96	80	376	16	45
1350050	11350050	50	40	31	76	138	86	110	96	536	16	25
1350063	11350063	63	50	38	90	166	106	129	118	1109	16	15

One Nut Valve
Threaded

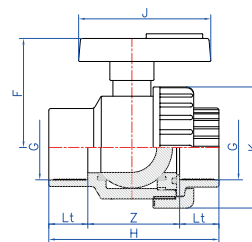

Cod MG
1351

Cod Plasson
11351

Cod MG	Cod Plasson	G	DN	I	Z	J	H	F	K	Weight	PN	Pack
1351003	11351003	3/8"	10	14	41	69	45	65	45	85	16	200
1351005	11351005	1/2"	15	16	41	73	45	65	45	90	16	200
1351007	11351007	3/4"	20	19	49	87	54	73	55	159	16	110
1351010	11351010	1"	25	22	55	99	66	78	66	222	16	60
1351013	11351013	1.1/4"	32	26	64	116	74	96	80	376	16	45
1351015	11351015	1.1/2"	40	31	76	138	86	110	96	536	16	25
1351020	11351020	2"	50	38	90	166	106	129	118	1109	16	15

One Nut Valve
Male-Female-Threaded

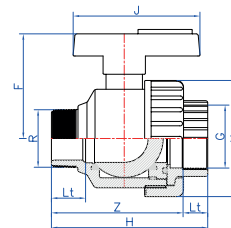

Cod MG
1361

Cod Plasson
11361

Cod MG	Cod Plasson	RxG	Lt	Z	H	F	J	K	DN	Weight	PN	Pack
1361003	11361003	3/8"	12	55	67	45	65	45	10	76	16	200
1361005	11361005	1/2"	15	57	72	45	65	45	15	82	16	200
1361007	11361007	3/4"	16	68	84	54	73	55	20	150	16	110
1361010	11361010	1"	19	79	98	66	78	66	25	214	16	60
1361013	11361013	1.1/4"	22	90	112	74	96	80	32	359	16	45
1361015	11361015	1.1/2"	22	108	130	86	110	96	40	504	16	25
1361020	11361020	2"	26	133	159	106	129	118	50	1086	16	15

VALVES Threaded Support

Two Nut Valve Cemented

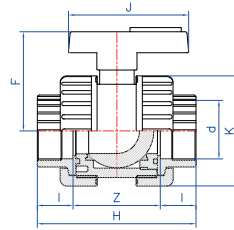

Cod MG
1140

Cod Plasson
11140

Cod MG	Cod Plasson	d	I	Z	H	F	J	K	DN	Weight	PN	Pack
1140016	11140016	16	14	43	71	45	65	45	10	93	16	160
1140020	11140020	20	16	43	75	45	65	45	15	103	16	160
1140025	11140025	25	19	51	89	54	73	55	20	201	16	90
1140032	11140032	32	22	58	102	66	78	66	25	281	16	50
1140040	11140040	40	26	68	120	74	96	80	32	475	16	40
1140050	11140050	50	31	80	142	86	110	96	40	672	16	28
1140063	11140063	63	38	93	169	106	129	118	50	1434	16	13
*1140075	*11140075	75	44	137	215	128	132	139	65	2000	10	4
*1140090	*11140090	90	51	148	250	146	153	165	80	3250	10	2
*1140110	*11140110	110	61	173	295	173	185	207	100	6300	10	2

*AVAILABLE WHILE STOCKS LAST

*1120075	*11120075	75	44	137	215	128	132	139	65	2000	10	4
*1120090	*11120090	90	51	148	250	146	153	165	80	3250	10	2
*1120110	*11120110	110	61	173	295	173	185	207	100	6300	10	2

*STARTING FROM 2019
WITH SUPPORT FOR ACTUATOR

Two Nut Valve Threaded

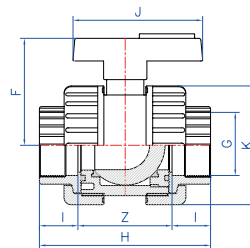

Cod MG
1141

Cod Plasson
11141

Cod MG	Cod Plasson	G	Lt	Z	H	F	J	K	DN	Weight	PN	Pack
1141003	11141003	3/8"	12	47	71	45	65	45	10	95	16	160
1141005	11141005	1/2"	15	45	75	45	65	45	15	105	16	160
1141007	11141007	3/4"	16	57	89	54	73	55	20	204	16	90
1141010	11141010	1"	19	64	102	66	78	66	25	284	16	50
1141013	11141013	1.1/4"	22	76	120	74	96	80	32	479	16	40
1141015	11141015	1.1/2"	22	98	142	86	110	96	40	681	16	28
1141020	11141020	2"	26	117	169	106	129	118	50	1439	16	13
*1141025	*11141025	2.1/2"	44	137	215	128	132	139	65	2000	10	4
*1141030	*11141030	3"	51	148	250	146	153	165	80	3250	10	2
*1141040	*11141040	4"	61	173	295	173	185	207	100	6300	10	2

*AVAILABLE WHILE STOCKS LAST

*1121025	*11121025	2.1/2"	44	137	215	128	132	139	65	2000	10	4
*1121030	*11121030	3"	51	148	250	146	153	165	80	3250	10	2
*1121040	*11121040	4"	61	173	295	173	185	207	100	6300	10	2

*STARTING FROM 2019
WITH SUPPORT FOR ACTUATOR

VALVES Threaded Support

Two Nut Valve Cemented - Potable water

Cod MG
1140A

Cod Plasson

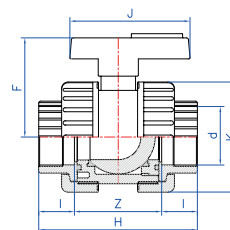

Cod MG	Cod Plasson	d	I	Z	H	F	J	K	DN	Weight	PN	Pack
1140016A		16	14	43	71	45	65	45	10	93	16	160
1140020A		20	16	43	75	45	65	45	15	103	16	160
1140025A		25	19	51	89	54	73	55	20	201	16	90
1140032A		32	22	58	102	66	78	66	25	281	16	50
1140040A		40	26	68	120	74	96	80	32	475	16	40
1140050A		50	31	80	142	86	110	96	40	672	16	28
1140063A		63	38	93	169	106	129	118	50	1434	16	13
*1140075A		75	44	137	215	128	132	139	65	2000	10	4
*1140090A		90	51	148	250	146	153	165	80	3250	10	2
*1140110A		110	61	173	295	173	185	207	100	6300	10	2

*AVAILABLE WHILE STOCKS LAST

*1120075A		75	44	137	215	128	132	139	65	2000	10	4
*1120090A		90	51	148	250	146	153	165	80	3250	10	2
*1120110A		110	61	173	295	173	185	207	100	6300	10	2

*STARTING FROM 2019

WITH SUPPORT FOR ACTUATOR

Two Nut Valve Threaded - Potable water

Cod MG
1141A

Cod Plasson

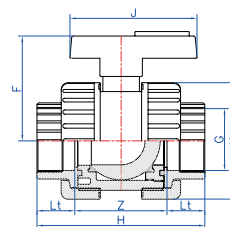

Cod MG	Cod Plasson	G	Lt	Z	H	F	J	K	DN	Weight	PN	Pack
1141003A		3/8"	12	47	71	45	65	45	10	95	16	160
1141005A		1/2"	15	45	75	45	65	45	15	105	16	160
1141007A		3/4"	16	57	89	54	73	55	20	204	16	90
1141010A		1"	19	64	102	66	78	66	25	284	16	50
1141013A		1.1/4"	22	76	120	74	96	80	32	479	16	40
1141015A		1.1/2"	22	98	142	86	110	96	40	681	16	28
1141020A		2"	26	117	169	106	129	118	50	1439	16	13
*1141025A		2.1/2"	44	137	215	128	132	139	65	2000	10	4
*1141030A		3"	51	148	250	146	153	165	80	3250	10	2
*1141040A		4"	61	173	295	173	185	207	100	6300	10	2

*AVAILABLE WHILE STOCKS LAST

*1121025A		2.1/2"	44	137	215	128	132	139	65	2000	10	4
*1121030A		3"	51	148	250	146	153	165	80	3250	10	2
*1121040A		4"	61	173	295	173	185	207	100	6300	10	2

*STARTING FROM 2019

WITH SUPPORT FOR ACTUATOR

VALVES Threaded Support

Bistop Valve - Cemented

4 7* 12X0
112X0

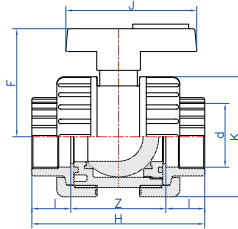

Cod MG **12X0** Cod Plasson **112X0**

Cod MG	Cod Plasson	d	DN	I	Z	H	F	J	K	Weight	PN	Pack
12X0016	112X0016	16	10	14	43	71	45	65	45	93	16	80
12X0020	112X0020	20	15	16	43	75	45	65	45	103	16	80
12X0025	112X0025	25	20	19	51	89	54	73	55	201	16	52
12X0032	112X0032	32	25	22	58	102	66	78	66	281	16	30
12X0040	112X0040	40	32	26	68	120	74	96	80	475	16	22
12X0050	112X0050	50	40	31	80	142	86	110	96	672	16	13
12X0063	112X0063	63	50	38	93	169	106	129	118	1434	16	6
*12X0075	*112X0075	75	65	44	137	215	128	132	139	2000	10	4
*12X0090	*112X0090	90	80	51	148	250	146	153	165	3250	10	2
*12X0110	*112X0110	110	100	61	173	295	173	185	207	6300	10	2

* with FPM O-Ring * AVAILABLE WHILE STOCKS LAST

INDIVIDUALLY TESTED

2 3* 12X0
112X0

*12X0075	*112X0075	75	65	44	137	215	128	132	139	2000	10	4
*12X0090	*112X0090	90	80	51	148	250	146	153	165	3250	10	2
*12X0110	*112X0110	110	100	61	173	295	173	185	207	6300	10	2

* STARTING FROM 2019 * with FPM O-Ring WITH SUPPORT FOR ACTUATOR

Bistop Valve - Threaded

4 7* 12X1
112X1

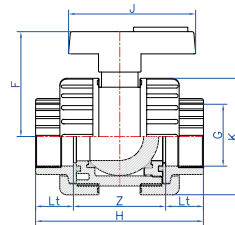

Cod MG **12X1** Cod Plasson **112X1**

Cod MG	Cod Plasson	G	DN	I	Z	H	F	J	K	Weight	PN	Pack
12X1003	112X1003	3/8"	10	12	47	71	45	65	45	95	16	80
12X1005	112X1005	1/2"	15	15	45	75	45	65	45	105	16	80
12X1007	112X1007	3/4"	20	16	57	89	54	73	55	204	16	52
12X1010	112X1010	1"	25	19	64	102	66	78	66	284	16	30
12X1013	112X1013	1.1/4"	32	22	76	120	74	96	80	479	16	22
12X1015	112X1015	1.1/2"	40	22	98	142	86	110	96	681	16	13
12X1020	112X1020	2"	50	26	117	169	106	129	118	1439	16	6
*12X1025	*112X1025	2.1/2"	65	44	137	215	128	132	139	2000	10	4
*12X1030	*112X1030	3"	80	51	148	250	146	153	165	3250	10	2
*12X1040	*112X1040	4"	100	61	173	295	173	185	207	6300	10	2

* with FPM O-Ring * AVAILABLE WHILE STOCKS LAST

INDIVIDUALLY TESTED

2 3* 12X1
112X1

*12X1025	*112X1025	2.1/2"	65	44	137	215	128	132	139	2000	10	4
*12X1030	*112X1030	3"	80	51	148	250	146	153	165	3250	10	2
*12X1040	*112X1040	4"	100	61	173	295	173	185	207	6300	10	2

* STARTING FROM 2019 * with FPM O-Ring WITH SUPPORT FOR ACTUATOR

VALVES Threaded Support

One Nut Valve Cemented

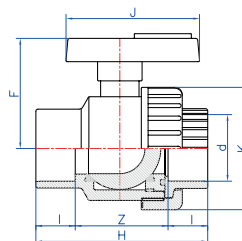

Cod MG
1340

Cod Plasson
11340

Cod MG	Cod Plasson	d	DN	I	Z	J	H	F	K	Weight	PN	Pack
1340016	11340016	16	10	14	41	69	45	65	45	85	16	200
1340020	11340020	20	15	16	41	73	45	65	45	90	16	200
1340025	11340025	25	20	19	49	87	54	73	55	159	16	110
1340032	11340032	32	25	22	55	99	66	78	66	222	16	60
1340040	11340040	40	32	26	64	116	74	96	80	376	16	45
1340050	11340050	50	40	31	76	138	86	110	96	536	16	25
1340063	11340063	63	50	38	90	166	106	129	118	1109	16	15
*1340075	*11340075	75	65	44	137	215	128	132	139	1800	10	8
*1340090	*11340090	90	80	51	148	250	146	153	165	2850	10	6
*1340110	*11340110	110	100	61	173	295	173	185	207	5300	10	3

*AVAILABLE WHILE STOCKS LAST

*1320075	*11320075	75	65	44	137	215	128	132	139	1800	10	8
*1320090	*11320090	90	80	51	148	250	146	153	165	2850	10	6
*1320110	*11320110	110	100	61	173	295	173	185	207	5300	10	3

*STARTING FROM 2019

WITH SUPPORT FOR ACTUATOR

One Nut Valve Threaded

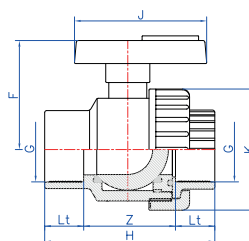

Cod MG
1341

Cod Plasson
11341

Cod MG	Cod Plasson	G	DN	I	Z	J	H	F	K	Weight	PN	Pack
1341003	11341003	3/8"	10	14	41	69	45	65	45	85	16	200
1341005	11341005	1/2"	15	16	41	73	45	65	45	90	16	200
1341007	11341007	3/4"	20	19	49	87	54	73	55	159	16	110
1341010	11341010	1"	25	22	55	99	66	78	66	222	16	60
1341013	11341013	1.1/4"	32	26	64	116	74	96	80	376	16	45
1341015	11341015	1.1/2"	40	31	76	138	86	110	96	536	16	25
1341020	11341020	2"	50	38	90	166	106	129	118	1109	16	15
*1341025	*11341025	2.1/2"	65	44	137	215	128	132	139	1800	10	8
*1341030	*11341030	3"	80	51	148	250	146	153	165	2850	10	6
*1341040	*11341040	4"	100	61	173	295	173	185	207	5300	10	3

*AVAILABLE WHILE STOCKS LAST

*1321025	*11321025	2.1/2"	65	44	137	215	128	132	139	1800	10	8
*1321030	*11321030	3"	80	51	148	250	146	153	165	2850	10	6
*1321040	*11321040	4"	100	61	173	295	173	185	207	5300	10	3

*STARTING FROM 2019

WITH SUPPORT FOR ACTUATOR

VALVES Threaded Support

One Nut Valve Male-Female-Threaded

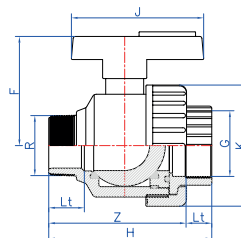

Cod MG
1371

Cod Plasson
11371

Cod MG	Cod Plasson	RxG	Lt	Z	H	F	J	K	DN	Weight	PN	Pack
1371005	11371005	1/2"	15	57	72	45	65	45	15	82	16	200
1371007	11371007	3/4"	16	68	84	54	73	55	20	150	16	110
1371010	11371010	1"	19	79	98	66	78	66	25	214	16	60
1371013	11371013	1.1/4"	22	90	112	74	96	80	32	359	16	45
1371015	11371015	1.1/2"	22	108	130	86	110	96	40	504	16	25
1371020	11371020	2"	26	133	159	106	129	118	50	1086	16	15

Compression Valve Female-Threaded-Compression

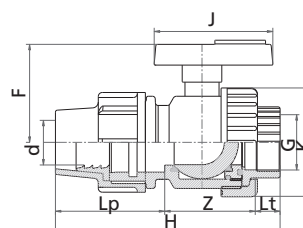

Cod MG
1379

Cod Plasson
11379

Cod MG	Cod Plasson	dxG	Lt	Z	Lp	H	F	J	K	DN	Weight	PN	Pack
1379020	11379052	1/2" x 20	15	40	57	112	45	65	45	15	128	16	110
1379025	11379075	3/4" x 25	16	50	58	124	54	73	55	20	212	16	70
1379032	11379103	1" x 32	19	53	65	137	66	78	66	25	308	16	40
1379040	11379184	1.1/4" x 40	22	67	85	174	74	96	80	32	531	16	25
1379050	11379155	1.1/2" x 50	22	82	90	194	86	110	96	40	753	16	20
1379063	11379206	2" x 63	26	95	109	230	106	129	118	50	1463	16	10

VALVES Threaded Support

Two Nut Valve PE End Connector

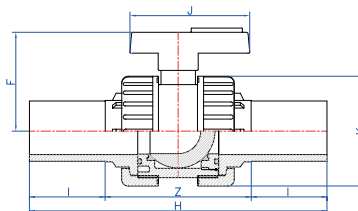

Cod MG
1148

Cod Plasson
111480

Cod MG	Cod Plasson	d	DN	l	Z	J	H	F	K	Weight	PN	Pack
1148020	111480020	20	15	41	63	65	145	45	45	110	16	80
1148025	111480025	25	20	50	93	73	193	54	55	205	16	60
1148032	111480032	32	25	44	102	78	190	66	66	267	16	40
1148040	111480040	40	32	48	107	96	203	74	80	471	16	30
1148050	111480050	50	40	54	130	110	238	86	96	686	16	15
1148063	111480063	63	50	64	142	129	270	106	118	1418	16	10
*1148075	*111480075	75	65	80	171	132	331	128	139	2000	10	4
*1148090	*111480090	90	80	88	200	153	376	146	165	3250	10	3
*1148110	*111480110	110	100	91	233	185	415	173	207	6300	10	1

*DELIVERY PROGRAM

*AVAILABLE WHILE STOCKS LAST

*1188075	*111880075	75	65	80	171	132	331	128	139	2000	10	4
*1188090	*111880090	90	80	88	200	153	376	146	165	3250	10	3
*1188110	*111880110	110	100	91	233	185	415	173	207	6300	10	1

*STARTING FROM 2019

WITH SUPPORT FOR ACTUATOR

Compression Valve PE End Connector

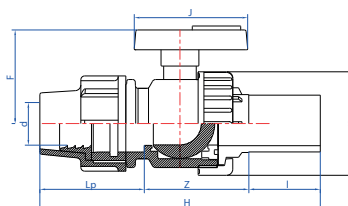

Cod MG
1378

Cod Plasson
11378

Cod MG	Cod Plasson	d	DN	l	Z	Lp	H	F	J	K	Weight	PN	Pack
1378020	11378020	20	15	41	50	57	148	45	65	45	119	16	80
1378025	11378025	25	20	50	71	58	179	54	73	55	208	16	70
1378032	11378032	32	25	44	75	65	184	66	78	66	288	16	40
1378040	11378040	40	32	48	86,5	85	219,5	74	96	80	500	16	30
1378050	11378050	50	40	54	107	90	251	86	110	96	720	16	15
1378063	11378063	63	50	64	119,5	109	292,5	106	129	118	1440	16	10

CHECK VALVES

Check Valve

Cemented

8 6 9 0 10X0
110X0

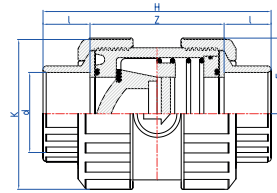

Cod MG **10X0** Cod Plasson **110X0**

Cod MG	Cod Plasson	d	l	Z	H	F	K	Weight	PN	Pack
10X0016	110X0016	16	14	43	71	23	45	90	16	80
10X0020	110X0020	20	16	43	75	23	45	90	16	80
10X0025	110X0025	25	19	51	89	29	55	145	16	52
10X0032	110X0032	32	22	58	102	37	66	245	16	30
10X0040	110X0040	40	26	68	120	44	80	410	16	22
10X0050	110X0050	50	31	80	142	54	96	690	16	13
10X0063	110X0063	63	38	93	169	65	118	1170	16	6
10X0075	110X0075	75	44	137	215	108	139	1810	10	4
10X0090	110X0090	90	51	148	250	125	165	3015	10	3
10X0110	110X0110	110	61	173	295	148	207	5540	10	2

*AVAILABLE WHILE STOCKS LAST

7 4 5 1 10X0
110X0

*10X0075	*110X0075	75	44	137	215	108	139	1810	10	4
*10X0090	*110X0090	90	51	148	250	125	165	3015	10	3
*10X0110	*110X0110	110	61	173	295	148	207	5540	10	2

*STARTING FROM 2019

Cod	oring	spring
1000XXX	FPM	316-No coated
1060XXX	EPDM	316-No coated
1080XXX	EPDM	316-PTFE coated
1090XXX	FPM	316-PTFE coated

Check Valves: is equipped with a spring mechanism and closes tightly with two meters of water column (around 0,2 bar)
The minimum opening pressure is around half meter of water column (mlbar 50)

Check Valve

Threaded

8 6 9 0 10X1
110X1

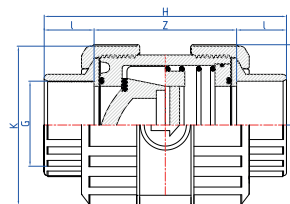

Cod MG **10X1** Cod Plasson **110X1**

Cod MG	Cod Plasson	G	l	Z	H	F	K	DN	Weight	PN	Pack
10X1003	110X1003	3/8"	14	43	71	23	45	10	90	16	80
10X1005	110X1005	1/2"	16	43	75	23	45	15	90	16	80
10X1007	110X1007	3/4"	19	51	89	29	55	20	145	16	52
10X1010	110X1010	1"	22	58	102	37	66	25	245	16	30
10X1013	110X1013	1.1/4"	26	68	120	44	80	32	410	16	22
10X1015	110X1015	1.1/2"	31	80	142	54	96	40	690	16	13
10X1020	110X1020	2"	38	93	169	65	118	50	1170	16	6
10X1025	110X1025	2.1/2"	44	137	215	108	139	65	1810	10	4
10X1030	110X1030	3"	51	148	250	125	165	80	3015	10	3
10X1040	110X1040	4"	61	173	295	148	207	100	5540	10	2

*AVAILABLE WHILE STOCKS LAST

7 4 5 1 10X1
110X1

*10X1025	*110X1025	2.1/2"	44	137	215	108	139	65	1810	10	4
*10X1030	*110X1030	3"	51	148	250	125	165	80	3015	10	3
*10X1040	*110X1040	4"	61	173	295	148	207	100	5540	10	2

*STARTING FROM 2019

Cod	oring	spring
1001XXX	FPM	316-No coated
1061XXX	EPDM	316-No coated
1081XXX	EPDM	316-PTFE coated
1091XXX	FPM	316-PTFE coated

Check Valves: is equipped with a spring mechanism and closes tightly with two meters of water column (around 0,2 bar)
The minimum opening pressure is around half meter of water column (mlbar 50)

CHECK VALVES

Knocker Tee
Cemented

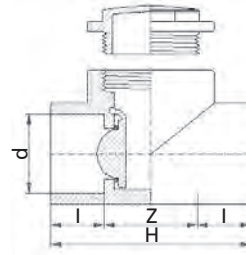

Cod MG
5048

Cod Plasson
050408

Cod MG	Cod Plasson	d	l	Z	H	Weight	PN	Pack
5048032	050408032	32	22	39	86	138	10	80
5048040	050408040	40	26	47	101	200	10	40
5048050	050408050	50	31	59	123	292	10	20
5048063	050408063	63	38	73	150	500	10	20

Knocker Tee: PN10 - Minimum closing pressure, 200 mlbar
For the assembly maintain the horizontal direction of the arrow
Horizontal hydraulic system with upper inspection well
Vertical hydraulic system with arrowhead at the top

FOOT VALVES

Foot Valve Cemented

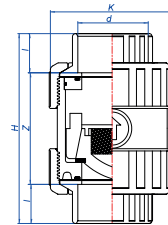

Cod MG **16X0** Cod Plasson **116X0**

Cod MG	Cod Plasson	d	DN	l	Z	H	F	K	Weight	PN	Pack
16X0016	116X0016	16	10	14	43	71	23	45	93	16	80
16X0020	116X0020	20	15	16	43	75	23	45	93	16	80
16X0025	116X0025	25	20	19	51	89	29	55	155	16	52
16X0032	116X0032	32	25	22	58	102	37	66	265	16	30
16X0040	116X0040	40	32	26	68	120	44	80	465	16	22
16X0050	116X0050	50	40	31	80	142	54	96	785	16	13
16X0063	116X0063	63	50	38	93	169	65	118	1355	16	6
*16X0075	*116X0075	75	65	44	137	215	108	139	2100	10	4
*16X0090	*116X0090	90	80	51	148	250	125	165	3500	10	3
*16X0110	*116X0110	110	100	61	173	295	148	207	6415	10	2

*AVAILABLE WHILE STOCKS LAST



*17X0075	*117X0075	75	65	44	137	215	108	139	2100	10	4
*17X0090	*117X0090	90	80	51	148	250	125	165	3500	10	3
*17X0110	*117X0110	110	100	61	173	295	148	207	6415	10	2

*STARTING FROM 2019

with EPDM O-ring 11640
with FPM O-ring 11600

Foot Valves: allow the fluid to flow in one direction only closes tightly with two meters of water column (round 0,2 bar)

Foot Valve Threaded

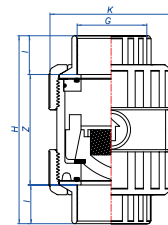

Cod MG **16X1** Cod Plasson **116X1**

Cod MG	Cod Plasson	G	DN	Lt	Z	H	F	K	Weight	PN	Pack
16X1003	116X1003	3/8"	10	12	47	71	23	45	95	16	80
16X1005	116X1005	1/2"	15	15	45	75	23	45	105	16	80
16X1007	116X1007	3/4"	20	16	57	89	29	55	204	16	52
16X1010	116X1010	1"	25	19	64	102	37	66	284	16	30
16X1013	116X1013	1.1/4"	32	22	76	120	44	80	479	16	22
16X1015	116X1015	1.1/2"	40	22	98	142	54	96	681	16	13
16X1020	116X1020	2"	50	26	117	169	65	118	1439	16	6
*16X1025	*116X1025	2.1/2"	65	44	137	215	108	139	2200	10	4
*16X1030	*116X1030	3"	80	51	148	250	125	165	3600	10	3
*16X1040	*116X1040	4"	100	61	173	295	148	207	6600	10	2

*AVAILABLE WHILE STOCKS LAST



*17X1025	*117X1025	2.1/2"	65	44	137	215	108	139	2200	10	4
*17X1030	*117X1030	3"	80	51	148	250	125	165	3600	10	3
*17X1040	*117X1040	4"	100	61	173	295	148	207	6600	10	2

*STARTING FROM 2019

with EPDM O-ring 11641
with FPM O-ring 11601

Foot Valves: allow the fluid to flow in one direction only closes tightly with two meters of water column (round 0,2 bar)

AIR RELEASE VALVES

Air Release Valve Cemented



Cod MG
16X0

Cod Plasson
116X0

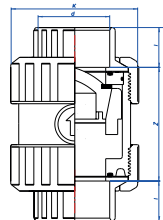

Cod MG	Cod Plasson	d	DN	l	Z	H	F	K	Weight	PN	Pack
16X0016	116X0016	16	10	14	43	71	23	45	88	16	80
16X0020	116X0020	20	15	16	43	75	23	45	88	16	80
16X0025	116X0025	25	20	19	51	89	29	55	145	16	52
16X0032	116X0032	32	25	22	58	102	37	66	240	16	30
16X0040	116X0040	40	32	26	68	120	44	80	405	16	22
16X0050	116X0050	50	40	31	80	142	54	96	680	16	13
16X0063	116X0063	63	50	38	93	169	65	118	1145	16	6
*16X0075	*116X0075	75	65	44	137	215	108	139	2100	10	4
*16X0090	*116X0090	90	80	51	148	250	125	165	3500	10	3
*16X0110	*116X0110	110	100	61	173	295	148	207	6415	10	2

*AVAILABLE WHILE STOCKS LAST



*17X0075	*117X0075		65	44	137	215	108	139	2100	10	4
*17X0090	*117X0090		80	51	148	250	125	165	3500	10	3
*17X0110	*117X0110		100	61	173	295	148	207	6415	10	2

*STARTING FROM 2019

with EPDM O-ring 11630
with FPM O-ring 11690

Air release valves: are used for aeration and venting of process plants, due to function only vertical mounting is possible and closes tightly with two meters of water column - around 0,2 bar

Air Release Valve Threaded



Cod MG
16X1

Cod Plasson
116X1

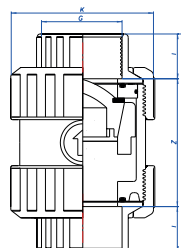

Cod MG	Cod Plasson	G	DN	Lt	Z	H	F	K	Weight	PN	Pack
16X1003	116X1003	3/8"	10	12	47	71	23	45	88	16	80
16X1005	116X1005	1/2"	15	15	45	75	23	45	88	16	80
16X1007	116X1007	3/4"	20	16	57	89	29	55	145	16	52
16X1010	116X1010	1"	25	19	64	102	37	66	240	16	30
16X1013	116X1013	1.1/4"	32	22	76	120	44	80	405	16	22
16X1015	116X0015	1.1/2"	40	22	98	142	54	96	680	16	13
16X1020	116X1020	2"	50	26	117	169	65	118	1145	16	6
*16X1025	*116X1025	2.1/2"	65	44	137	215	108	139	2200	10	4
*16X1030	*116X1030	3"	80	51	148	250	125	165	3600	10	3
*16X1040	*116X1040	4"	100	61	173	295	148	207	6600	10	2

*AVAILABLE WHILE STOCKS LAST



*17X1025	*117X1025	2.1/2"	65	44	137	215	108	139	2200	10	4
*17X1030	*117X1030	3"	80	51	148	250	125	165	3600	10	3
*17X1040	*117X1040	4"	100	61	173	295	148	207	6600	10	2

*STARTING FROM 2019

with EPDM O-ring 11631
with FPM O-ring 11691

Air release valves: are used for aeration and venting of process plants, due to function only vertical mounting is possible and closes tightly with two meters of water column - around 0,2 bar

VALVES ACCESSORIES

**Valve End
Cemented**

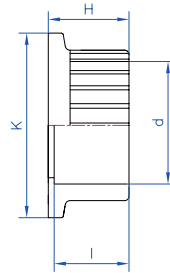
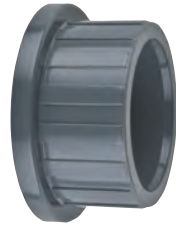

Cod MG
EI

Cod Plasson
11110

Cod MG	Cod Plasson	d	K	H	I	Weight	PN
EI016	11110016	16	33	20	14	9	16
EI020	11110020	20	33	20	16	9	16
EI025	11110025	25	40	22	19	25	16
EI032	11110032	32	50	26	22	20	16
EI040	11110040	40	61	30	26	41	16
EI050	11110050	50	73	34	31	68	16
EI063	11110063	63	94	42	38	114	16
EI075	11110075	75	119	47	44	174	16
EI090	11110090	90	143	56	51	300	16
EI110	11110110	110	165	67	61	492	16

**Valve End
Threaded**

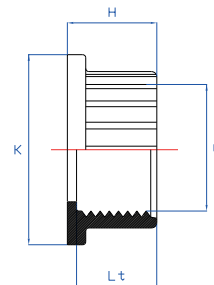

Cod MG
EF

Cod Plasson
11111

Cod MG	Cod Plasson	G	K	H	Lt	Weight	PN
EF003	11111003	3/8"	33	20	12	9	16
EF005	11111005	1/2"	33	20	16	9	16
EF007	11111007	3/4"	40	22	17	25	16
EF010	11111010	1"	50	26	20	20	16
EF013	11111018	1.1/4"	61	30	23	41	16
EF015	11111015	1.1/2"	73	34	23	68	16
EF020	11111020	2"	94	42	27	114	16
EF025	11111025	2.1/2"	119	47	32	174	16
EF030	11111030	3"	143	56	35	300	16
EF040	11111040	4"	165	67	42	492	16

VALVES ACCESSORIES

Blue Handle

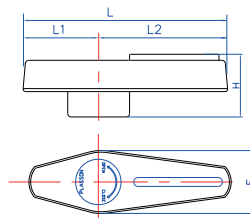

Cod MG
MB

Cod Plasson
11112

Cod MG	Cod Plasson	d	E	H	L	L1	L2	Weight
MB020	11112205	16-3/8"	22	22,15	61,7	24,2	37,5	11,2
MB020	11112205	20-1/2"	22	22,15	61,7	24,2	37,5	11,2
MB025	11112257	25-3/4"	24	25,2	72	29,5	42,5	16
MB032	11112321	32-1"	26,5	30	77,5	30	47,5	20,2
MB040	11112408	40-1.1/4"	31	32,1	94	37,4	56,6	30
MB050	11112505	50-1.1/2"	35	34,9	107,8	42	65,8	38,6
MB063	11112632	63-2"	41,5	38	130	52,6	77,3	60,4
MB075	11112755	75-2.1/2"	45,3	38	132,8	54,9	77,9	77,2
MB090	11112903	90-3"	51,2	42,9	152,7	63	89,7	117,8
MB110	11112114	110-4"	56,5	47,3	185,7	75,9	109,1	168,8

Red Handle

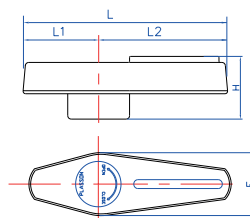

Cod MG
MR

Cod Plasson
11113

Cod MG	Cod Plasson	d	E	H	L	L1	L2	Weight
MR020	11113205	16-3/8"	22	22,15	61,7	24,2	37,5	11,2
MR020	11113205	20-1/2"	22	22,15	61,7	24,2	37,5	11,2
MR025	11113257	25-3/4"	24	25,2	72	29,5	42,5	16
MR032	11113321	32-1"	26,5	30	77,5	30	47,5	20,2
MR040	11113408	40-1.1/4"	31	32,1	94	37,4	56,6	30
MR050	11113505	50-1.1/2"	35	34,9	107,8	42	65,8	38,6
MR063	11113632	63-2"	41,5	38	130	52,6	77,3	60,4
MR075	11113755	75-2.1/2"	45,3	38	132,8	54,9	77,9	77,2
MR090	11113903	90-3"	51,2	42,9	152,7	63	89,7	117,8
MR110	11113114	110-4"	56,5	47,3	185,7	75,9	109,1	168,8

BlueA Handle

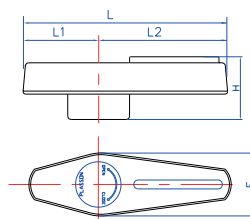

Cod MG
MBA

Cod Plasson

Cod MG	Cod Plasson	d	E	H	L	L1	L2	Weight
MB020A		16-3/8"	22	22,15	61,7	24,2	37,5	11,2
MB020A		20-1/2"	22	22,15	61,7	24,2	37,5	11,2
MB025A		25-3/4"	24	25,2	72	29,5	42,5	16
MB032A		32-1"	26,5	30	77,5	30	47,5	20,2
MB040A		40-1.1/4"	31	32,1	94	37,4	56,6	30
MB050A		50-1.1/2"	35	34,9	107,8	42	65,8	38,6
MB063A		63-2"	41,5	38	130	52,6	77,3	60,4
MB075A		75-2.1/2"	45,3	38	132,8	54,9	77,9	77,2
MB090A		90-3"	51,2	42,9	152,7	63	89,7	117,8
MB110A		110-4"	56,5	47,3	185,7	75,9	109,1	168,8

VALVES ACCESSORIES

Valve Nut

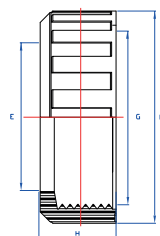

Cod MG
GH

Cod Plasson
11114

Cod MG	Cod Plasson	G	E	E1	H	Weight	PN
GH020	11114016	16-3/8"	29	45	18	16	16
GH020	11114020	20-1/2"	29	45	18	16	16
GH025	11114025	25-3/4"	34	55	21	27	16
GH032	11114032	32-1"	41	66	26	46	16
GH040	11114040	40-1.1/4"	52	80	29	75	16
GH050	11114050	50-1.1/2"	65	96	36	133	16
GH063	11114063	63-2"	79	118	40	198	16
GH075	11114075	75-2.1/2"	96	139	52	282	16
GH090	11114090	90-3"	117	165	59	436	16
GH110	11114110	110-4"	142	207	68	830	16

PE End Connector

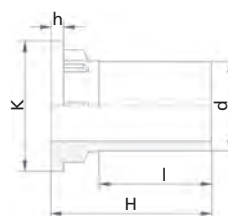

Cod MG
PEI

Cod Plasson
1115.207

Cod MG	Cod Plasson	d	K	h	H	l	W	Weight
PEI020	1115.207.020	20	33	5	53	41	11	11
PEI025	1115.207.025	25	40	6	77	50	24	24
PEI032	1115.207.032	32	49	6	68	44	33	33
PEI040	1115.207.040	40	60	7	71	48	48	48
PEI050	1115.207.050	50	73	9	82	54	85	85
PEI063	1115.207.063	63	91	10	90	64	130	130
*PEI075	*1115.207.075	75	110	7	105	80	222	222
*PEI090	*1115.207.090	90	134	8	119	88	348	348
*PEI110	*1115.207.110	110	163	10	127	91	590	590

* DELIVERY PROGRAM

VALVES ACCESSORIES



Set of O-Rings

115 / 124* / 127 / 135 / 134 / 122*

valve code 111500/1	Ø 16 - 63	set 115	valve code 11270/1	Ø 16 - 110	set 127**
valve code 113500/1	Ø 16 - 63	set 135	valve code 11340/1	Ø 16 - 110	set 134
valve code 11361	Ø 16 - 63	set 135	valve code 111480	Ø 16 - 110	set 124
valve code 11379	Ø 16 - 63	set 134	valve code 11120/1	Ø 75 - 110	set 122
valve code 11371	Ø 16 - 63	set 134	valve code 11140/1 - 11240/1	Ø 16 - 110	set 124
valve code 11378	Ø 16 - 63	set 134	valve code 12240/1 - 12370/1	Ø 75 - 110	set 122
			valve code 11320/1 - 11188	Ø 75 - 110	set 122

O-Ring For Stem

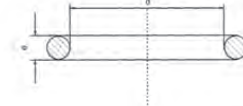
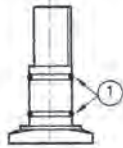

	16-3/8"	20-1/2"	25-3/4"	32-1"	40-11/4"	50-11/2"	63-2"	75-21/2"	90-3"	110-4"
Type 1	7219 7,2x1,9	7219 7,2x1,9	952 9,5x2	114 11,11x1,78	3043 10,78x2,72	356 13,95x2,62	467 17,04x3,53	475 18,64x3,53	487 21,82x3,53	134 25,8x3,53
Type 1								4100 24,99x3,53	4112 28,17x3,53	4131 32,92x3,53

Normal Support

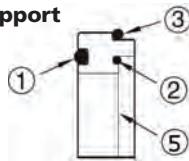

O-Ring For Spacing

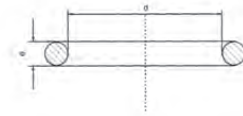

Threaded Support

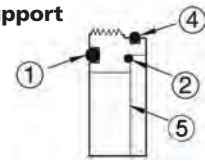

	16-3/8"	20-1/2"	25-3/4"	32-1"	40-11/4"	50-11/2"	63-2"	75-21/2"	90-3"	110-4"
Type 1	3075 18,72x2,62	3075 18,72x2,62	3100 25,07x2,62	4118 29,75x3,53	4150 37,7x3,53	6187 47x5,43	6237 59,7x5,34	6325 84,92x5,34	6387 97,79x5,34	119 117,48x5,34
Type 2	9999 17,5x1,5	9999 17,5x1,5	2093 23,52x1,78	2118 29,87x1,78	3143 36,17x2,62	3181 45,7,2,62	3231 58,42x2,62	4287 72,62x3,53	4350 88,5x3,53	4425 107,5x3,53
Type 3	130 22,23x2,62	130 22,23x2,62	3118 29,83x2,62	4150 37,7x3,53	152 47,62x3,53	161 57,15x3,53	174 71,63x3,53			
Type 4	130 22,23x2,62	130 22,23x2,62	3118 29,83x2,62	3143 36,17x2,62	3181 45,7x2,62	3231 58,42x2,62	174 71,63x3,53	4362 91,67x3,53	6450 113,7x5,34	217 142,9x5,34
Type 5	PTFE020 15x21x3	PTFE020 15x21x3	PTFE025 20x27x3,5	PTFE032 25x33x4	PTFE040 32x42x5	PTFE050 40x51x5,5	PTFE063 50x63x6,5	PTFE075 65x82x6	PTFE090 80,5x95,6x7,5	PTFE110 100,5x116x9
Type 1								6300 75,57x5,34	6362 91,44x5,34	199 117,50x5,34
Type 2								4287 72,62x3,63	4337 85,32x3,63	4425 107,50x3,53
Type 4								4387 98,02x3,53	6450 113,70x5,34	219 146,10x5,34

Only for compression side valves

O-Ring For Body

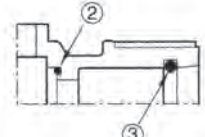
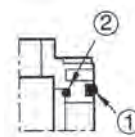

	16-3/8"	20-1/2"	25-3/4"	32-1"	40-11/4"	50-11/2"	63-2"	75-21/2"	90-3"	110-4"
Type 1	3075 18,72x2,62	3075 18,72x2,62	3100 25,07x2,62	4118 29,75x3,53	4150 37,7x3,53	6187 47x5,43	6237 59,7x5,34	6325 84,92x5,34	6387 97,79x5,34	119 117,48x5,34
Type 2	9999 17,5x1,5	9999 17,5x1,5	2093 23,52x1,78	2118 29,87x1,78	3143 36,17x2,62	3181 45,7,2,62	3231 58,42x2,62	4287 72,62x3,53	4350 88,5x3,53	4425 107,5x3,53
Type 3		070020020	070020025	070020032	070020040	070020050	070020063			
Type 5	PTFE020 15x21x3	PTFE020 15x21x3	PTFE025 20x27x3,5	PTFE032 25x33x4	PTFE040 32x42x5	PTFE050 40x51x5,5	PTFE063 50x63x6,5	PTFE075 65x82x6	PTFE090 80,5x95,6x7,5	PTFE110 100,5x116x9
Type 1								6300 75,57x5,34	6362 91,44x5,34	199 117,50x3,54
Type 2								4287 72,62x3,63	4337 85,32x3,53	4425 107,50x3,53

* Possible set for potable water

** Set of FPM O-Rings

VALVES ACCESSORIES
CHECK - FOOT - AIR - RELEASE VALVES

Set of O-Rings
*** 100 / 106 / 107**



valve code 11080/1	∅ 16 - 110 set 106	valve code 11070/1-11040/1-11050/1-11010/1	∅ 75 - 110 set 107
valve code 11060/1	∅ 16 - 110 set 106	valve code 11770/1-11070/1	∅ 75 - 110 set 107
valve code 11090/1	∅ 16 - 110 set 100 *	valve code 11730/1-11790/1	∅ 75 - 110 set 107
valve code 11000/1	∅ 16 - 110 set 100 *		
valve code 11640/1	∅ 16 - 110 set 106		
valve code 11600/1	∅ 16 - 110 set 100 *		
valve code 11630/1	∅ 16 - 110 set 106		
valve code 11690/1	∅ 16 - 110 set 100 *		

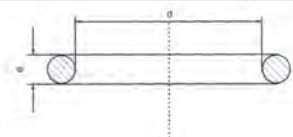

Gasket For Piston

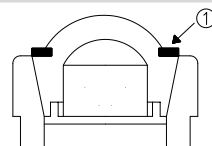

	16-3/8"	20-1/2"	25-3/4"	32-1"	40-11/4"	50-11/2"	63-2"	75-21/2"	90-3"	110-4"
Type 1	*GP020V 12,5x20x2	*GP020V 12,5x20x2	*GP025V 17x24x2	*GP032V 22x32x2	*GP040V 38x28x3	*GP050V 51x35x4	*GP063V 58x42x4	*GP075V 57x77x4	*GP090V 72x93x4	*GP090V 110x90x4

Normal Support

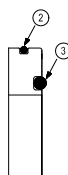

O-Ring For Spacing

	16-3/8"	20-1/2"	25-3/4"	32-1"	40-11/4"	50-11/2"	63-2"	75-21/2"	90-3"	110-4"
Type 2	130 22,23x2,62	130 22,23x2,62	3118 29,83x2,62	3143 36,17x2,62	3181 45,7x2,62	3231 58,42x2,62	174 71,63x3,53	4362 91,67x3,53	6450 113,7x5,34	4562 142,47x3,53
Type 3	3075 18,72x2,62	3075 18,72x2,62	3100 25,07x2,62	4118 29,75x3,53	4150 37,7x3,53	6187 47x5,43	6237 59,7x5,34	6325 84,92x5,34	6387 97,79x5,34	119 117,48x5,34
Type 2								4350 98,02x3,53	4425 107,5x3,53	420835 140x4
Type 3								6300 75,57x5,34	6362 91,44x5,34	199 117,50x5,34

O-Ring For Body

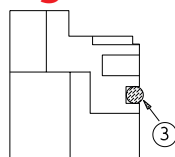

	16-3/8"	20-1/2"	25-3/4"	32-1"	40-11/4"	50-11/2"	63-2"	75-21/2"	90-3"	110-4"
Type 3	3075 18,72x2,62	3075 18,72x2,62	3100 25,07x2,62	4118 29,75x3,53	4150 37,7x3,53	6187 47x5,43	6237 59,7x5,34	6325 84,92x5,34	6387 97,79x5,34	119 117,48x5,34
Type 3								6300 75,57x5,34	6362 91,44x5,34	119 117,50x5,34

Stainless steel 316 core Spring

Spring

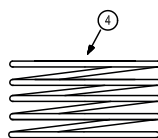

Teflon coated on stainless steel 316 core Spring

	16-3/8"	20-1/2"	25-3/4"	32-1"	40-11/4"	50-11/2"	63-2"	75-21/2"	90-3"	110-4"
Type 4	ML020	ML020	ML025	ML032	ML040	ML050	ML063	ML075	ML090	ML110

* Set of FPM O-Rings

TECHNICAL SPECIFICATIONS - FITTINGS

Product Description

DESCRIPTION

Precision moulded pressure pipe fittings and flanges made from PVC-U250 suitable for PVC pipe systems up to 16 bar. Our comprehensive range of items and sizes can be joined either by cold solvent cementing or through threading. Sizes and dimensions conform to international standard. All fittings are suitable for potable water, beverages, and food contact, as well as corrosive* fluid transports.

* For specific chemicals, please consult your sales rep.

STANDARDS

Products conform to the requirements of ISO 264, 727, 2536, 3460, KIWA Criteria Std. Nr. 54 and DIN 8063, 19532, UNI EN 1452-3, AFNOR 54-029 and 54-028.

MATERIALS

PVC-U250 unplasticized poly (vinyl chloride) meeting the above mentioned Standards.

Injection-moulded components: PVC-U250.

Metal reinforced rings: on the female threads INOX AISI 430.

Gaskets and O-Rings: EPDM.

MARKINGS

The fittings and valves incorporate the following information moulded in relief:

- PLASSON Trade Mark (registered in most countries)
- Diameter of connection
- Nominal pressure
- Type of Material

COLOUR

All fittings and valves are grey, in accordance with PVC-U pressure pipeline standards.

ITEMS

Sockets, 45° and 90° Elbows, 90° Tees, Bushes, Unions, Reducers, Adaptors, Hose Nozzles, Caps, Plugs, Nipples, Flanges, Flange Adaptors, Ball Valves, Foot Valves, Check Valves, and Air Release Valves.

SANITARY LAWS

The PLASSON fittings and valves conform to the sanitary laws and regulations in force in the various European Countries and in the U.S. relating to transportation of potable water, wine, beverages and food.

APPLICATION FIELDS

Potable water systems, irrigation systems (including fertilization), installation for wine, beer, beverages and other fluids, industrial plants, conveyance of acids, bases, salts, fresh or swimming water, ship installations. (for special installations, please contact your Plasson supplier).

JOINTING TYPES

The fittings and the valves are available with three types of connections:

Plain ends for solvent cement jointing to pressure pipes of metric dimensions.

Fourth digit in the catalogue no. is "O" (XXXO).

Threaded ends to be screwed onto BSP threaded pipes/ fittings.

Fourth digit in the catalogue no. is "1" (XXX1).

A combination of ends ("adaptor fittings") suitable for joining a PVC pipeline of the metric dimensions to a BSP threaded pipe, fitting, valve or accessory (PVC or other materials).

Fourth digit in the catalogue no. is "2" (XXX2).

SIZES

For standard pipes of the ISO metrical range: 12, 16, 20, 25, 32, 40, 50, 63, 75, 90, 110, 125, 140, 160, 200, 225mm. And for pipes of the BSP threaded range: 1/4", 3/8", 1/2", 3/4", 1", 1 1/4", 1 1/2", 2", 2 1/4", 3", 4", 5".

THREADS

PLASSON fittings are female threaded (cylindrical) and male threaded (conical) in accordance with EN 10226-1, BS 21, and EN 10226-2 standards.

FLANGES

PLASSON backing flanges are to be used in connection with the flange adaptors (catalogue no. 5500, 5510, and 5520). The number, sizes and distance between the centre of the holes conform to UNI 2223, EN 1452-3, ISO 2536 and DIN 8063 for pressure classes of 10-16 Bar.

ACCESSORIES

The fitting range is completed by some accessories such as solvent cement, primer, PTFE tape, etc.

WORKING TEMPERATURES

CELSIUS	0°-25°	25°-30°	30°-35°	35°-40°	40°-45°
PFA* (PN) Bar	16	14,4	12,8	11,2	10
PFA* (PN) Bar	10	9	8	7	6,25

* in accordance with EN 805

PRESSURES

The fittings and valves, in accordance with EN 805 standard, have three working pressures: PTA (PA), PMA and PEA.

To every PFA values are connected the following PMA and PEA:

	PFA -PA	PMA	PEA
PRESSURES	16	20	24
IN BAR	10	12,5	15
	6	7,5	9

TECHNICAL SPECIFICATIONS - FITTINGS

Product Description

PVC PROPERTIES

The following are the required properties for injection moulded PVC-U250 fittings and valves in accordance with ISO-EN-UNI Standards:

CHARACTERISTICS	UNITS	VALUES	STANDARDS
Density at 23°C	Kg/dm ³	1.39	ISO 1183
Vicat 5 Kg.	°C	77	ISO 306
Tensile impact strength	KJ/m ²	≥513	ISO 527
Tensile strength at break	MPa	≥49	ISO 527
Elongation at break	%	≥120	ISO 527
Yield stress	MPa	46	ISO 527
Flexural modulus	MPa	≥3000	ISO 527
Heat conductivity at 23 °C	W/mK	0,13-0,19	ASTM C 177
Specific heat at 23 °C	J/Kg K	900-1000	-
Fire resistance (0,85 mm.)		V 0	UL 94

Permissible working pressures in accordance with DIN8062

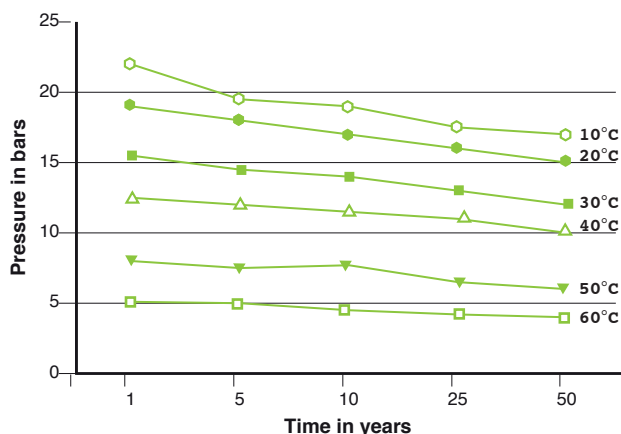

ABBREVIATIONS USED IN THIS CATALOGUE

d, d ₁	Nominal inside diameter
G, G ₁	Nominal size of thread in inches
DN	Nominal bore
D, D ₁	Outside diameter
E, E ₁	Maximum overall external diameter
l, l ₁	Internal length of cementing
L, L ₁ , L ₂	External length for cementing
Lt, Lt ₁	Length of thread
Z	Length from pipe stop to centre/other pipe stop
C	External size of octagon
B	Length of rim
Dp	Pitch circle diameter of bolt holes in flanges
S	Diameter of bolt holes in flanges
N	Number of bolt holes in flange
e	Cross section diameter of O-Ring
H	Total length
w	Weight in grams

SYMBOLS & DEFINITIONS FITTINGS

PN - Nominal Pressure in Bar - Allowable operating pressure conveying water at 20°C during 50 years.

PFA - Allowable Operating Pressure - Maximum hydrostatic pressure that a component is capable of withstanding continuously in service (EN 805:1999); for water at temperatures up to 25°C: PFA=PN.

PMA - Allowable Maximum Operating Pressure - Maximum pressure occurring from time to time, including surge, that a component is capable of withstanding in service (EN 805:1999).

PEA - Allowable Site Test Pressure - Maximum hydrostatic pressure that a newly installed component is capable of withstanding for a relatively short duration, in order to ensure the integrity and tightness of the pipeline (EN 805:1999).

MRS: Minimum Required Strength

PVC-U: Unplasticized Poly (vinyl chloride)

PVC-U250: Unplasticized Poly (vinyl chloride) material for injection moulded components, such as PLASSON fittings and valves, with a proved MRS-value of at least 25Mpa.

EPDM: Ethylene Propylene Rubber

FPM: Fluoride Rubber (VITON)

PTFE: Polytetrafluoroethylene

TECHNICAL SPECIFICATIONS - VALVES

Product Description

DESCRIPTION

Precision moulded valves made from uPVC suitable for line pipe systems up to 16 bar. Our comprehensive range of items and sizes can be connected either by cold solvent cementing or through threading. Sizes and dimensions conform to international standards. All valves are suitable for potable water, beverages, food as well as corrosive fluid transport.

MATERIALS

PVC-U250 (unplasticized polyvinyl chloride) meeting the standards of DIN-BS-UNI-AFNOR, KIWA, etc

O-Rings

- 1) EPDM (ethylene-propylene copolymer). Hardness: 70 shore, unless otherwise specified
- 2) FPM (Fluorised-Rubber) Hardness: 70 shore, unless otherwise specified

Springs

- 1) PTFE coated stainless steel 316 core
- 2) Coated Springs: Teflon coated on stainless steel 316 core

Gaskets (on ball)

- 1) PTFE (Polytetra Fluorised-Ethylene)
- 2) PE

MARKINGS

The valves incorporate the following information moulded in relief:

- Plasson Trade Mark (registered in most countries)
- Diameter of connection
- Nominal pressure
- Type of Material

COLOUR

All valves are grey, in accordance with PVC-U pressure pipeline standards.
Handles are blue or red.

ITEMS

Ball Valves, Check Valves, Foot Valves, Air Release Valves

SANITARY LAWS

The PLASSON valves conform to the sanitary laws and regulations in force in the various European Countries and in the U.S. relating to transportation of potable water, wine, beverages and food.

APPLICATION FIELDS

Potable water systems, irrigation systems (including fertilization), installation for wine, beer, beverages and other fluids, industrial plants, conveyence of acids, bases, salts, fresh or swimming water pool, ship installations. (for special installations, please contact your Plasson supplier).

JOINTING TYPES

The valves are available with three types of connections: Plain ends for solvent cement jointing to pressure pipes of metric dimensions. *Fourth digit in the catalogue no. is "O" (XXXO).* Threaded ends to be screwed onto BSP threaded pipes/ fittings. *Fourth digit in the catalogue no. is "1" (XXX1).*

SIZES

For standard pipes of the ISO metrical range of mm: 16, 20, 25, 32, 40, 50, 63, 75, 90, 110

And for pipes of the BSP threaded range: 3/8", 1/2", 3/4", 1", 1 1/4", 1 1/2", 2", 2 1/2", 3"

THREADS

PLASSON valves are female threaded (cylindrical) and male threaded (conical) according with EN 10226-1/EN 10226-2, DIN 2999 and BS 21 standards.

MECHANICAL PROPERTIES

Maximum working pressure in bars:

ø16-63: PN-16

ø75-110: PN-10 (NEW, STARTING FROM 2019, PN-16)

Knocker Tee: PN10 - Minimum closing pressure, 200 mlbar

For the assembly maintain the horizontal direction of the arrow
Horizontal hydraulic system with upper inspection well
Vertical hydraulic system with arrowhead at the top

Check Valves: is equipped with a spring mechanism and closes tightly with two meters of water column (around 0,2 bar). The minimum opening pressure is around half meter of water column (50 mlbar).

Air release valves: are used for aeration and venting of process plants, due to function only vertical mounting is possible and closes tightly with two meters of water column (around 0,2 bar).

Foot Valves: allow the fluid to flow in one direction only closes tightly with two meters of water column (around 0,2 bar).

PVC PROPERTIES

The following are the required properties for an injection moulded PVC fittings withstanding pressures PN16 in accordance with UNI standards:

CHARACTERISTICS		UNITS	VALUES	STANDARDS
Density		Kg/m ³	1.4	ISO 1183
Vicat (50N)		°C	76	ISO 306-B
Yield stress		MPa	45	ISO 527
Tensile Strength at break (23°)		MPa	40	ISO 527
Elongation at break		%	120	ISO 527
Tensile Modulus		MPa	3000	ISO 527
			Unnotched j/m	Notched j/m
IZOD Impact Strength	ASTM 23°C		NB	270
	D256 0°C		NB	150
	ISO180 0°C		>1500	70

Permissible working pressures in accordance with DIN8062

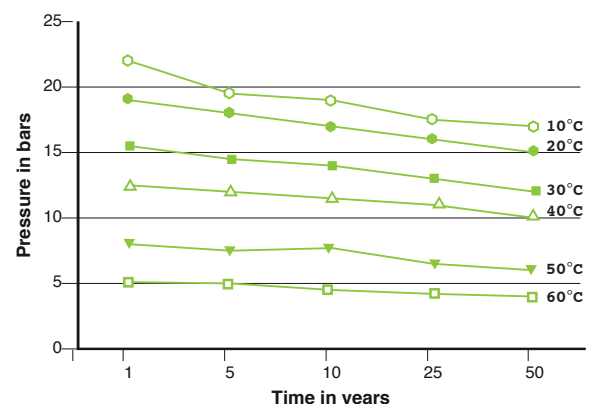

TECHNICAL SPECIFICATIONS - VALVES

Product Description

ABBREVIATIONS USED IN THIS CATALOGUE

d	Nominal inside diameter
F	Distance from centre of valve to top of handle or valve
G	Nominal size of thread in inches
J	Length of handle
K	Outside diameter or nut
DN	Nominal bore corresponding approx to the inside diameter of the pipe
D	Outside diameter
I	Internal length for cementing
L	External length for cementing
Lp	Internal length to PE pipe
Lt	Length of thread
Z	Length from pipe stop to centre/other pipe stop
H	Total length
W	Weight in grams

SYMBOLS & DEFINITIONS FITTINGS

PN - Nominal Pressure in Bar - Allowable operating pressure conveying water at 20OC during 50 years.

PFA - Allowable Operating Pressure - Maximum hydrostatic pressure that a component is capable of withstanding continuously in service (EN 805:1999); for water at temperatures up to 25OC: PFA=PN.

PMA - Allowable Maximum Operating Pressure - Maximum pressure occurring from time to time, including surge, that a component is capable of withstanding in service (EN 805:1999).

PEA - Allowable Site Test Pressure - Maximum hydrostatic pressure that a newly installed component is capable of withstanding for a relatively short duration, in order to ensure the integrity and tightness of the pipeline (EN 805:1999).

MRS: Minimum Required Strength

PVC-U: Unplasticized Poly (vinyl chloride)

PVC-U250: Unplasticized Poly (vinyl chloride) material for injectionmoulded components, such as PLASSON fittings and valves, with a proved MRS-value of at least 25Mpa.

EPDM: Ethylene Propylene Rubber

FPM: Fluoride Rubber (VITON)

PTFE: Polytetrafluoroethylene

ASSEMBLY INSTRUCTIONS

Normal Support

Cod MG
1150

Cod Plasson
11150

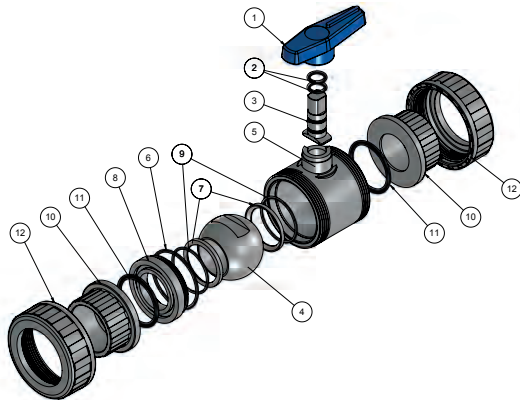

Instructions for connection to the system -

- Completely unscrew the ring nuts (12) and fit them to the pipe that the valve is to be connected to.
- Either glue or screw couplings (10) at the pipe ends.
- Position the valve body (5) between the two couplings.
- Lock the ring nuts for both sides.

Instructions for disassembling and reassemble -

- Completely unscrew the ring nuts (12).
Remove the valve body (5) radially.
Remove the handle (1) by pulling upwards.
Release the gasket support (8) by pushing the ball (4) through the valve while the valve is closed.
Remove O-Rings (6*, 9*, 11*) from gasket

support (8) and PTFE gasket (7*) using a suitable tool in order to prevent damage.
Remove the ball (4) which was previously positioned during the closing phase.
Remove the stem (3) by pushing downwards and extracting it from inside the valve body.
Remove the O-Ring (2*) from the stem (3) using a suitable tool.
Remove the O-Ring (9*) and the PTFE gasket (7*) using a suitable tool.
To assemble the valve, follow the same procedure in the opposite sequence.

Notes: The valve shall be supplied with a pre-set radial seal, applicable to average operating conditions; due to particular operating conditions, it might be necessary to turn clockwise or anticlockwise the ring nuts (12) from the side of the gasket support (8).

Cod MG
1350
1351

Cod Plasson
11350
11351

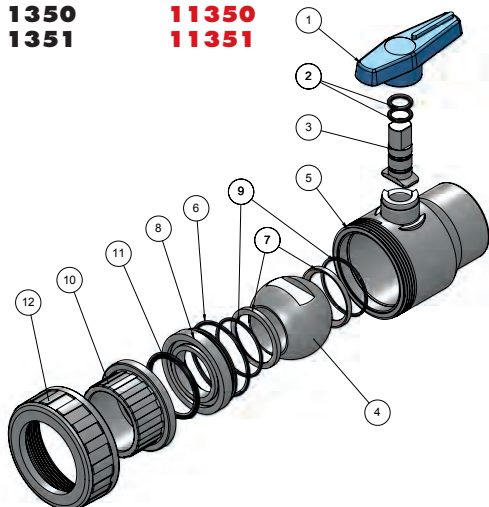

Instructions for connection to the system -

- Completely unscrew the ring nut (12) and fit it to the pipe that the valve is to be connected to.
- Either glue or screw fixed side (5) to the pipe end.
- Either glue or screw coupling (10) to the pipe end.
- Lock the ring nut.

Instructions for disassembling and reassemble -

- Completely unscrew the ring nut (12).
Remove the valve body (5) radially.
Remove the handle (1) by pulling upwards.
Release the gasket support (8) by pushing the ball (4) through the valve while the valve is closed.
Remove O-Rings (6*, 9*, 11*) from gasket

support (8) and PTFE gasket (7*) using a suitable tool in order to prevent damage.
Remove the ball (4) which was previously positioned during the closing phase.
Remove the stem (3) by pushing downwards and extracting it from inside the valve body.
Remove the O-Ring (2*) from the stem (3) using a suitable tool.
Remove the O-Ring (9*) and the PTFE gasket (7*) using a suitable tool.
To assemble the valve, follow the same procedure in the opposite sequence.

Notes: The valve shall be supplied with a pre-set radial seal, applicable to average operating conditions; due to particular operating conditions, it might be necessary to turn clockwise or anticlockwise the ring nut (12).

Cod MG
1361

Cod Plasson
11361

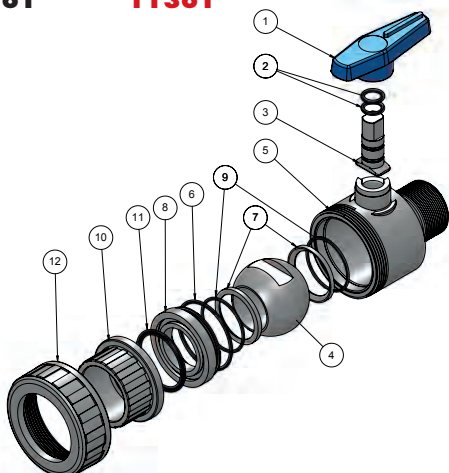

Instructions for connection to the system -

- Completely unscrew the ring nut (12) and fit it to the pipe that the valve is to be connected to.
- Screw fixed side (5) to the pipe end.
- Screw coupling (10) to the pipe end.
- Lock the ring nut.

Instructions for disassembling and reassemble -

- Completely unscrew the ring nut (12).
Remove the valve body (5) radially.
Remove the handle (1) by pulling upwards.
Release the gasket support (8) by pushing the ball (4) through the valve while the valve is closed.
Remove O-Rings (6*, 9*, 11*) from gasket support (8) and PTFE gasket (7*) using a

suitable tool in order to prevent damage.
Remove the ball (4) which was previously positioned during the closing phase.
Remove the stem (3) by pushing downwards and extracting it from inside the valve body.
Remove the O-Ring (2*) from the stem (3) using a suitable tool.
Remove the O-Ring (9*) and the PTFE gasket (7*) using a suitable tool.
To assemble the valve, follow the same procedure in the opposite sequence.

Notes: The valve shall be supplied with a pre-set radial seal, applicable to average operating conditions; due to particular operating conditions, it might be necessary to turn clockwise or anticlockwise the ring nut (12).

ASSEMBLY INSTRUCTIONS

Threaded Support

Cod MG
1140
1141
1140A

Cod Plasson
11140
11141

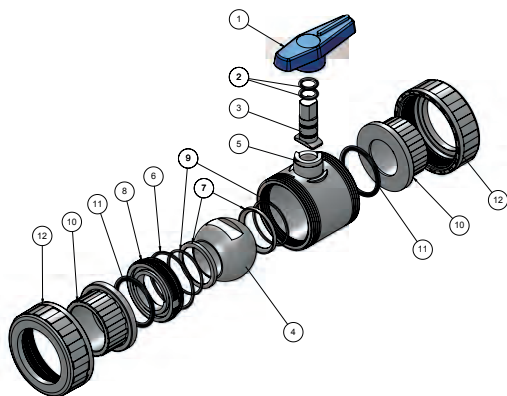

Instructions for connection to the system -

- Completely unscrew the ring nuts (12) and fit them to the pipe that the valve is to be connected to.
- Either glue or screw couplings (10) at the pipe ends.
- Position the valve body (5) between the two couplings.
- Lock the ring nuts for both sides.

Instructions for disassembling and reassemble -

- Completely unscrew the ring nuts (12).
Completely unscrew the ring nuts (12).
Remove the valve body (5) radially.
Remove the handle (1) by pulling upwards.
Insert the key in its seat in the gasket support (8).
Completely unscrew the gasket support (8) by rotating the handle anticlockwise.
Remove O-Rings (6*, 9*, 11*) from gasket support (8) and PTFE gasket (7*) using a suitable tool in order to prevent damage.

Remove the ball (4) which was previously positioned during the closing phase.
Remove the stem (3) by pushing downwards and extracting it from inside the valve body.
Remove the O-Ring (2*) from the stem (3) using a suitable tool.
Remove the O-Ring (9*) and the PTFE gasket (7*) using a suitable tool.
To assemble the valve, follow the same procedure in the opposite sequence.

Notes: The valve shall be supplied with a pre-set radial seal, applicable to average operating conditions; due to particular operating conditions, it might be necessary to follow the instructions below before performing the final step:

- Disconnected the handle (1) by pulling upwards.
- Insert the key in its seat in the gasket support (8).
- Turn clockwise or anticlockwise to adjust as required.

Cod MG
1240
1241
1270
1271

Cod Plasson
11240
11241
11270
11271

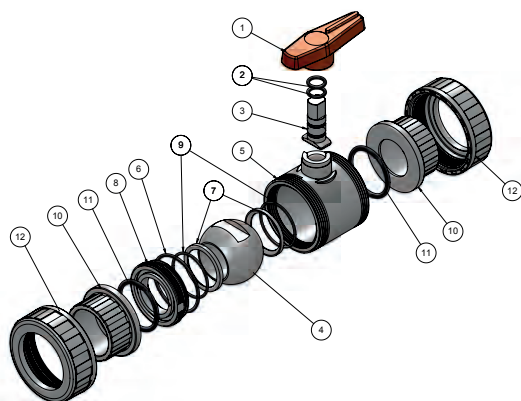

Instructions for connection to the system -

- Completely unscrew the ring nuts (12) and fit them to the pipe that the valve is to be connected to.
- Either glue or screw couplings (10) at the pipe ends.
- Position the valve body (5) between the two couplings.
- Lock the ring nuts for both sides.

Instructions for disassembling and reassemble -

- Completely unscrew the ring nuts (12).
Remove the valve body (5) radially.
Remove the handle (1) by pulling upwards.
Insert the key in its seat in the gasket support (8).
Completely unscrew the gasket support (8) by rotating the handle anticlockwise.
Remove O-Rings (6*, 9*, 11*) from gasket support (8) and PTFE gasket (7*) using a suitable tool in order to prevent damage.

Remove the ball (4) which was previously positioned during the closing phase.
Remove the stem (3) by pushing downwards and extracting it from inside the valve body.
Remove the O-Ring (2*) from the stem (3) using a suitable tool.
Remove the O-Ring (9*) and the PTFE gasket (7*) using a suitable tool.
To assemble the valve, follow the same procedure in the opposite sequence.

Notes: The valve shall be supplied with a pre-set radial seal, applicable to average operating conditions; due to particular operating conditions, it might be necessary to follow the instructions below before performing the final step:

- Disconnected the handle (1) by pulling upwards.
- Insert the key in its seat in the gasket support (8).
- Turn clockwise or anticlockwise to adjust as required.

ASSEMBLY INSTRUCTIONS

Threaded Support

Cod MG
1340
1341

Cod Plasson
11340
11341

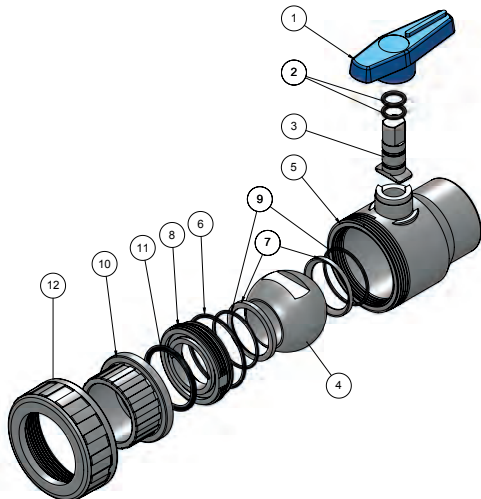

Instructions for connection to the system -

- Completely unscrew the ring nut (12) and fit it to the pipe that the valve is to be connected to.
- Either glue or screw fixed side (5) to the pipe end.
- Either glue or screw coupling (10) to the pipe end.
- Lock the ring nut.

Instructions for disassembling and reassemble -

- Completely unscrew the ring nut (12).
Remove the valve body (5) radially.
Remove the handle (1) by pulling upwards.
Insert the key in its seat in the gasket support (8).
Completely unscrew the gasket support (8) by rotating the handle anticlockwise.
Remove O-Rings (6*, 9*, 11*) from gasket support (8) and PTFE gasket (7*) using a suitable tool in order to prevent damage.

- Remove the ball (4) which was previously positioned during the closing phase.
Remove the stem (3) by pushing downwards and extracting it from inside the valve body.
Remove the O-Ring (2*) from the stem (3) using a suitable tool.
Remove the O-Ring (9*) and the PTFE gasket (7*) using a suitable tool.
To assemble the valve, follow the same procedure in the opposite sequence.

Notes: The valve shall be supplied with a pre-set radial seal, applicable to average operating conditions; due to particular operating conditions, it might be necessary to follow the instructions below before performing the final step:

1. Disconnected the handle (1) by pulling upwards.
2. Insert the key in its seat in the gasket support (8).
3. Turn clockwise or anticlockwise to adjust as required.

Cod MG
1371

Cod Plasson
11371

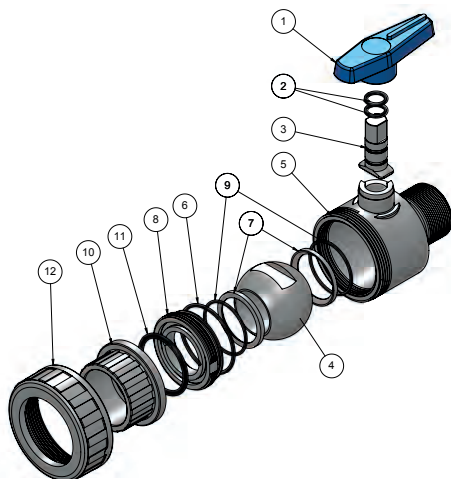

Instructions for connection to the system -

- Completely unscrew the ring nut (12) and fit it to the pipe that the valve is to be connected to.
- Screw fixed side (5) to the pipe end.
- Screw coupling (10) to the pipe end.
- Lock the ring nut.

Instructions for disassembling and reassemble -

- Completely unscrew the ring nut (12).
Remove the valve body (5) radially.
Remove the handle (1) by pulling upwards.
Insert the key in its seat in the gasket support (8).
Completely unscrew the gasket support (8) by rotating the handle anticlockwise.
Remove O-Rings (6*, 9*, 11*) from gasket support (8) and PTFE gasket (7*) using a suitable tool in order to prevent damage.
Remove the ball (4) which was previously positioned during the closing phase.

- Remove the stem (3) by pushing downwards and extracting it from inside the valve body.
Remove the O-Ring (2*) from the stem (3) using a suitable tool.
Remove the O-Ring (9*) and the PTFE gasket (7*) using a suitable tool.
To assemble the valve, follow the same procedure in the opposite sequence.

Notes: The valve shall be supplied with a pre-set radial seal, applicable to average operating conditions; due to particular operating conditions, it might be necessary to follow the instructions below before performing the final step:

1. Disconnected the handle (1) by pulling upwards.
2. Insert the key in its seat in the gasket support (8).
3. Turn clockwise or anticlockwise to adjust as required.

ASSEMBLY INSTRUCTIONS

Threaded Support

Cod MG
1379

Cod Plasson
11379

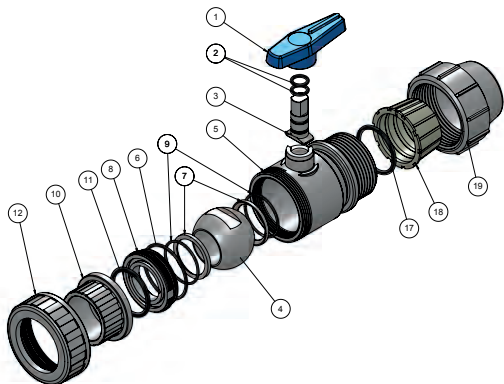

Instructions for connection to the system -

- A) Connect PE pipe to the compression nut (19).
- B) Completely unscrew the ring nuts (12) and fit them to the pipe that the valve is to be connected to.
- C) Either glue or screw couplings (10) at the pipe ends.
- D) Position the valve body (5) between the two couplings.
- E) Lock the ring nuts for both sides.

Instructions for disassembling and reassemble -

- Completely unscrew the ring nuts (12).
- Remove the valve body (5) radially.
- Remove the handle (1) by pulling upwards.
- Insert the key in its seat in the gasket support (8).
- Completely unscrew the gasket support (8) by rotating the handle anticlockwise.
- Remove O-Rings (6*, 9*, 11*) from gasket support (8) and PTFE gasket (7*) using a

suitable tool in order to prevent damage. Remove the ball (4) which was previously positioned during the closing phase. Remove the stem (3) by pushing downwards and extracting it from inside the valve body. Remove the O-Ring (2*) from the stem (3) using a suitable tool. Remove the O-Ring (9*) and the PTFE gasket (7*) using a suitable tool. To assemble the valve, follow the same procedure in the opposite sequence.

Notes: The valve shall be supplied with a pre-set radial seal, applicable to average operating conditions; due to particular operating conditions, it might be necessary to follow the instructions below before performing the final step:

1. Disconnected the handle (1) by pulling upwards.
2. Insert the key in its seat in the gasket support (8).
3. Turn clockwise or anticlockwise to adjust as required.

ASSEMBLY INSTRUCTIONS

Threaded Support

Cod MG
1148

Cod Plasson
111480

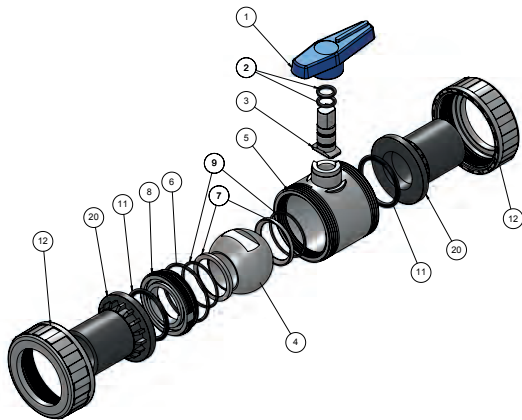

Instructions for connection to the system -

- Completely unscrew the ring nuts (12) and fit them to the pipe that the valve is to be connected to.
- Either connect to the compression fittings or electrofuse or butt weld PE spigots (20) at the pipe ends.
- Position the valve body (5) between the two couplings.
- Lock the ring nuts for both sides.

Instructions for disassembling and reassemble -

- Completely unscrew the ring nuts (12).
Remove the valve body (5) radially.
Remove the handle (1) by pulling upwards.
Insert the key in its seat in the gasket support (8).
Completely unscrew the gasket support (8) by rotating the handle anticlockwise.
Remove O-Rings (6*, 9*, 11*) from gasket support (8) and PTFE gasket (7*) using a suitable tool in order to prevent damage.

Remove the ball (4) which was previously positioned during the closing phase.
Remove the stem (3) by pushing downwards and extracting it from inside the valve body.
Remove the O-Ring (2*) from the stem (3) using a suitable tool.
Remove the O-Ring (9*) and the PTFE gasket (7*) using a suitable tool.
To assemble the valve, follow the same procedure in the opposite sequence.

Notes: The valve shall be supplied with a pre-set radial seal, applicable to average operating conditions; due to particular operating conditions, it might be necessary to follow the instructions below before performing the final step:

- Disconnected the handle (1) by pulling upwards.
- Insert the key in its seat in the gasket support (8).
- Turn clockwise or anticlockwise to adjust as required.

Cod MG
1378

Cod Plasson
11378

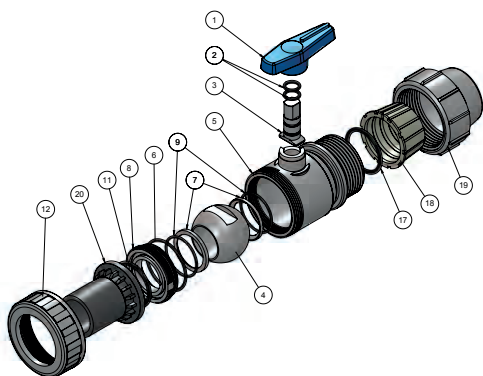

Instructions for connection to the system -

- Connect PE pipe to the compression nut (19).
- Completely unscrew the ring nuts (12) and fit them to the pipe that the valve is to be connected to.
- Either connect to the compression fittings or electrofuse or butt weld the PE spigots (20) at the pipe ends.
- Position the valve body (5) between the two couplings.
- Lock the ring nuts for both sides.

Instructions for disassembling and reassemble -

- Completely unscrew the ring nuts (12).
Remove the valve body (5) radially.
Remove the handle (1) by pulling upwards.
Insert the key in its seat in the gasket support (8).
Completely unscrew the gasket support (8) by rotating the handle anticlockwise.
Remove O-Rings (6*, 9*, 11*) from gasket support (8) and PTFE gasket (7*) using a

suitable tool in order to prevent damage.
Remove the ball (4) which was previously positioned during the closing phase.
Remove the stem (3) by pushing downwards and extracting it from inside the valve body.
Remove the O-Ring (2*) from the stem (3) using a suitable tool.
Remove the O-Ring (9*) and the PTFE gasket (7*) using a suitable tool.
To assemble the valve, follow the same procedure in the opposite sequence.

Notes: The valve shall be supplied with a pre-set radial seal, applicable to average operating conditions, it might be necessary to follow the instructions below before performing the final step:

- Disconnected the handle (1) by pulling upwards.
- Insert the key in its seat in the gasket support (8).
- Turn clockwise or anticlockwise to adjust as required.

ASSEMBLY INSTRUCTIONS

Check Valves

Cod MG	Cod Plasson
1080	11080
1081	11081
1060	11060
1061	11061
1090	11090
1091	11091
1000	11000
1001	11001

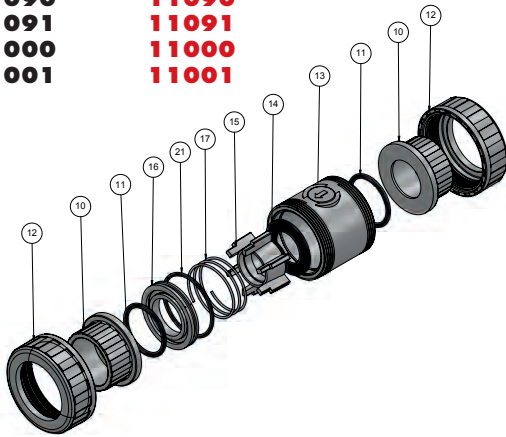

Instructions for connection to the system -

- Completely unscrew the ring nuts (12) and fit them to the pipe that the valve is to be connected to.
- Either glue or screw couplings (10) at the pipe ends.
- Position the valve body (5) between the two couplings.
- Lock the ring nuts for both sides.

and the spring assisted piston (15) does not fall out .

Remove the the spring assisted piston (15). To replace valve reverse the procedure being careful to set the O-Ring properly and grease it with silicon grease.

Instructions for disassembling and reassemble -

- Completely unscrew the ring nuts (12). Remove the valve body (13) radially. Release the gasket support (16) by pushing it and making sure that the spring (17)

Cod MG	Cod Plasson
1630	11630
1631	11631
1690	11690
1691	11691

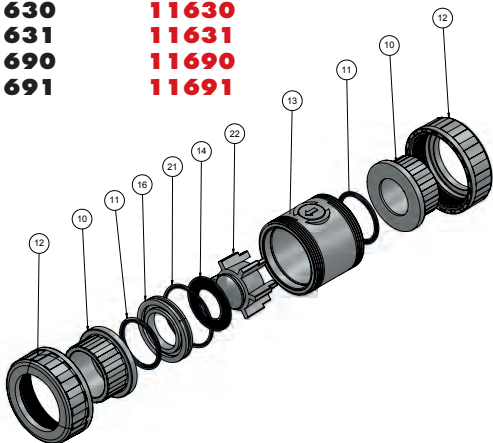

Instructions for connection to the system -

- Completely unscrew the ring nuts (12) and fit them to the pipe that the valve is to be connected to.
- Either glue or screw couplings (10) at the pipe ends.
- Position the valve body (5) between the two couplings.
- Lock the ring nuts for both sides.

Release the gasket support (16) by pushing it.

Remove the the spring assisted piston (15). To replace valve reverse the procedure being careful to set the O-Ring properly and grease it with silicon grease.

Instructions for disassembling and reassemble -

- Completely unscrew the ring nuts (12). Remove the valve body (13) radially.

Cod MG	Cod Plasson
1640	11640
1641	11641
1600	11600
1601	11601

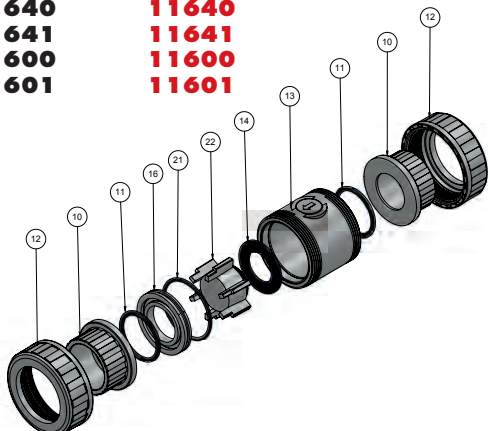

Instructions for connection to the system -

- Completely unscrew the ring nuts (12) and fit them to the pipe that the valve is to be connected to.
- Either glue or screw couplings (10) at the pipe ends.
- Position the valve body (5) between the two couplings.
- Lock the ring nuts for both sides.

Release the gasket support (16) by pushing it.

Remove the the spring assisted piston (15). To replace valve reverse the procedure being careful to set the O-Ring properly and grease it with silicon grease.

Instructions for disassembling and reassemble -

- Completely unscrew the ring nuts (12). Remove the valve body (13) radially.

CERTIFICATION



