

# Productcatalogus

**Milder**  
— VEELZIJDIG IN LEIDINGSYSTEMEN —

**Milder**

— VEELZIJDIG IN LEIDINGSYSTEMEN —

# Productcatalogus

PE Drukleidingen > PVC Drukleidingen > PP Drukleidingen  
> Afstandbediende afsluiters > C-PVC Programma >  
Blue-system programma > Binnen- en buitenriolering  
> Kabelbescherming en telecom > Milieu programma  
> Tanks > Folie en geotextielen > Halffabrikaten >  
RVS Programma > Malleable programma > Sanitair  
en verwarming > Metalen appendages en fittingen >  
Slangen en koppelingen > Pompen, filters en kabel  
> Lijm, reiniger en toebehoren > Bevestigingsmaterialen >  
Machines en gereedschappen

**Milder**

— VEELZIJDIG IN LEIDINGSYSTEMEN —

## Colofon

Productcatalogus 2017

© Milder Holland bv, Uitgever: Milder Holland bv, Druk: [www.fortmedia.nl](http://www.fortmedia.nl), Opmaak: [www.apollografisch.nl](http://www.apollografisch.nl).

Met de uitgave van deze productcatalogus vervallen alle vorige uitgaven. Drukfouten voorbehouden.

Al onze transacties geschieden volgens de 'Algemene verkoop- en leveringsvoorwaarden Milder Holland bv', welke zijn gedeponneerd bij de Kamer van Koophandel Centraal Gelderland te Arnhem. Het handelsregisternummer is 10029265.

Niets uit deze uitgave mag worden verveelvoudigd en/of openbaar gemaakt door middel van druk, fotokopie, microfilm, in enige digitale, elektronische, optische of op welke andere wijze ook, zonder voorafgaande schriftelijke toestemming van de uitgever.

# Inhoudsopgave

PE Drukleidingen > PVC Drukleidingen > PP Drukleidingen  
> Afstandbediende afsluiters > C-PVC Programma >  
Blue-system programma > Binnen- en buitenriolering  
> Kabelbescherming en telecom > Milieu programma  
> Tanks > Folie en geotextielen > Halffabrikaten >  
RVS Programma > Malleable programma > Sanitair  
en verwarming > Metalen appendages en fittingen >  
Slangen en koppelingen > Pompen, filters en kabel  
> Lijm, reiniger en toebehoren > Bevestigingsmaterialen >  
Machines en gereedschappen

**Milder**

— VEELZIJDIG IN LEIDINGSYSTEMEN —

## Beeldindex

|                         |  |    |
|-------------------------|--|----|
| <b>Beeldindex 01.02</b> | <b>Fittingen voor PE drukleidingen</b>   | 8  |
| <b>Beeldindex</b>       | <b>Lasmachines en toebehoren voor PE</b> | 13 |
| <b>Beeldindex 01.03</b> | <b>Afsluiters voor PE drukleidingen</b>  | 16 |
| <b>Beeldindex 02.02</b> | <b>Fittingen voor PVC drukleidingen</b>  | 17 |
| <b>Beeldindex 02.03</b> | <b>Afsluiters voor PVC drukleidingen</b> | 19 |
| <b>Beeldindex 13.02</b> | <b>Fittingen voor RVS leidingen</b>      | 20 |
| <b>Beeldindex 13.03</b> | <b>Afsluiters voor RVS leidingen</b>     | 20 |
| <b>Beeldindex 16.01</b> | <b>Fucoli programma</b>                  | 21 |
| <b>Beeldindex 16.02</b> | <b>PSI Programma</b>                     | 22 |
| <b>Beeldindex 16.03</b> | <b>Metalen appendages</b>                | 23 |

## 01. PE Drukleidingen

|   |   |    |
|---|---|----|
| <b>01.01 PE Drukbus</b>                       |   |    |
| 01.01.05                                      | PE 100 Drukbus                                  | 26 |
| 01.01.15                                      | ZPE Buis  | 27 |
| 01.01.20                                      | PE Drukbus voor gas                             | 26 |
| <b>01.02 Fittingen voor PE drukleidingen</b>  | <b>zie ook Beeldindex</b>                       |    |
| 01.02.05                                      | Plasson klemfittingen                           | 27 |
| 01.02.10                                      | Plasson klemfittingen onderdelen                | 33 |
| 21.03.05                                      | Plasson gereedschappen                          | 34 |
| 01.02.15                                      | Plasson PP draadfittingen                       | 35 |
| 01.02.20                                      | PP Aanboorzadels                                | 36 |
| 01.02.21                                      | Plasson Serie 1                                 | 37 |
| 21.03.05                                      | Plasson Serie 1 gereedschappen en toebehoren    | 40 |
| 01.02.25                                      | Plasson elektrofittingen                        | 41 |
| 01.02.30                                      | Plasson elektrofittingen aanboorzadels          | 46 |
| 01.02.31                                      | Plasson elektrofittingen voor riooltoepassingen | 48 |
| 01.02.35                                      | Plasson elektrofittingen hydranten              | 49 |
| 01.02.40                                      | PE Drukfittingen SDR17 met lange spie-einden    | 50 |
| 01.02.41                                      | PE Drukfittingen SDR17 T-stuk 45°               | 51 |
| 01.02.40                                      | PE Drukfittingen SDR17 kort model               | 52 |
| 01.02.42                                      | PE Drukfittingen SDR17 r=1,5d                   | 53 |
| 01.02.45                                      | PE Drukfittingen SDR11 met lange spie-einden    | 54 |
| 01.02.46                                      | PE Drukfittingen SDR11 T-stuk 45°               | 56 |
| 01.02.45                                      | PE Drukfittingen SDR11 kort model               | 56 |
| 01.02.47                                      | PE Drukfittingen SDR11 r=1,5d                   | 58 |
| 01.02.50                                      | PP Flenzen voor PE leidingen                    | 59 |
| 16.02.05                                      | PSI Pakkingen, afdichtingen en Petro-band       | 61 |
| 16.02.05                                      | PSI Link-Seal afsluitschakel                    | 62 |
| 01.02.60                                      | Hawle steekfittingen                            | 64 |
| 01.02.65                                      | Messing Beulco koppelingen                      | 66 |
| <b>01.03 Afsluiters voor PE drukleidingen</b> | <b>zie ook Beeldindex</b>                       |    |
| 01.03.05                                      | Plasson PE/PP afsluiters                        | 67 |
| 01.03.05                                      | Plasson PP lagedruk afsluiters                  | 69 |
| 03.03.05                                      | PE Spie-laseind voor afsluiters                 | 70 |
| 03.03.05                                      | PP Afsluiters overig                            | 70 |
| <b>01.04 Toebehoren voor PE drukleidingen</b> |   |    |
| 19.01.05                                      | Reiniger  | 72 |
| 20.01.--                                      | Bouten, moeren en sluitringen                   | 72 |

## 02. PVC Drukleidingen

|                          |                              |    |
|--------------------------|------------------------------|----|
| <b>02.01 PVC Drukbus</b> |                              |    |
| 02.01.05                 | PVC Drukbus                  | 74 |
| 02.01.10                 | PVC Drukbus met manchet      | 74 |
| 02.01.15                 | PVC Industriebuis            | 74 |
| 02.01.20                 | PVC Transparante buis        | 75 |
| 02.01.25                 | PVC Filterbuis en toebehoren | 76 |

|   |   |    |
|---|---|----|
| <b>02.02 Fittingen voor PVC drukleidingen</b> | <b>zie ook Beeldindex</b>                   |    |
| 02.02.05                                      | PVC Drukfittingen met lijmverbinding        | 77 |
| 02.02.10                                      | PVC Drukfittingen met lijm-/draadverbinding | 81 |
| 02.02.10                                      | PVC Drukfittingen met draadverbinding       | 86 |
| 02.02.15                                      | PVC Fittingen onderdelen                    | 88 |
| 02.02.05                                      | PVC Flenzen voor PVC leidingen              | 89 |
| 01.02.50                                      | PP Flenzen voor PVC leidingen               | 90 |
| 16.02.05                                      | PSI Pakkingen, afdichtingen en Petro-band   | 91 |
| 16.02.05                                      | PSI Link-Seal afsluitschakel                | 92 |
| 02.02.20                                      | PVC HV Hulpstukken gemaakt uit buis         | 94 |
| 02.02.21                                      | PVC HV Wanddoorvoer gemaakt uit buis        | 95 |
| 02.02.25                                      | PVC Drukfittingen met manchetverbinding     | 96 |

|  |                           |     |
|--|---------------------------|-----|
| <b>02.03 Afsluiters voor PVC drukleidingen</b> | <b>zie ook Beeldindex</b> |     |
| 02.03.05                                       | PVC Kogelkranen           | 97  |
| 02.03.10                                       | PVC Vuilvangers           | 98  |
| 02.03.15                                       | PVC Terugslagkleppen      | 99  |
| 02.03.20                                       | PVC Vlinderkleppen        | 100 |
| 02.03.25                                       | PVC Afsluiters overig     | 100 |
| 02.03.30                                       | Doorstoommeters           | 101 |

|  |                               |     |
|--|-------------------------------|-----|
| <b>02.04 Toebehoren voor PVC drukleidingen</b> |                               |     |
| 19.01.05                                       | Lijm en reiniger              | 102 |
| 19.02.05                                       | Kwasten                       | 103 |
| 20.01.--                                       | Bouten, moeren en sluitringen | 103 |

## 03. PP Drukleidingen

|   |                                    |     |
|---|------------------------------------|-----|
| <b>03.01 PP Drukbus</b>                       |                                    |     |
| 03.01.05                                      | PP Drukbus                         | 106 |
| <b>03.02 Fittingen voor PP drukleidingen</b>  |                                    |     |
| 03.02.05                                      | PP Drukfittingen SDR17,6           | 107 |
| 03.02.10                                      | PP Drukfittingen SDR11             | 108 |
| 03.02.15                                      | PP Drukfittingen SDR11 voor moflas | 109 |
| 01.02.50                                      | PP Flenzen voor PP leidingen       | 111 |
| 16.02.05                                      | PSI Pakkingen                      | 112 |
| <b>03.03 Afsluiters voor PP drukleidingen</b> |                                    |     |
| 03.03.05                                      | PP Afsluiters                      | 114 |
| <b>03.04 Toebehoren voor PP drukleidingen</b> |                                    |     |
| 19.01.05                                      | Reiniger                           | 116 |
| 20.01.--                                      | Bouten, moeren en sluitringen      | 116 |

## 04. Afstandbediende afsluiters

|   |   |     |
|---|---|-----|
| <b>04.01 Pneumatisch bediende afsluiters</b>            |   |     |
| 04.01.05  | Pneumatisch bediende kogelkranen            | 118 |
| 04.01.10  | Pneumatisch bediende vlinderkleppen         | 118 |
| 04.01.15  | Pneumatisch bediende membraanafsluiters     | 119 |
| <b>04.02 Elektrisch bediende afsluiters</b>             |   |     |
| 04.02.05  | Elektrisch bediende kogelkranen             | 120 |
| 04.02.10  | Elektrisch bediende vlinderkleppen          | 120 |
| 04.02.15  | Elektrisch bediende membraanafsluiters      | 121 |
| 04.02.20  | Elektrisch bediende membraanafsluiters ASCO | 122 |
| <b>04.03 Toebehoren voor afstandbediende afsluiters</b> |   |     |
| 04.03.05  | Accessoires voor afstandbediende afsluiters | 123 |
| 04.03.10  | Luchtleidingen en-fittingen                 | 124 |

## 05. C-PVC Programma

|                         |            |     |
|-------------------------|------------|-----|
| <b>05.01 C-PVC Buis</b> |            |     |
| 05.01.05                | C-PVC Buis | 126 |

|  |     |
|--|-----|
| <b>05.02 Fittingen voor C-PVC drukleidingen</b>  |     |
| 05.02.05 C-PVC Fittingen                         | 126 |
| <b>05.03 Afsluiters voor C-PVC drukleidingen</b> |     |
| 05.03.05 C-PVC Afsluiters                        | 128 |
| <b>05.04 Toebehoren voor C-PVC drukleidingen</b> |     |
| 19.01.05 Lijm en reiniger                        | 128 |

## 06. Blue-system programma

|  |     |
|--|-----|
| <b>06.01 Blue-system buis</b>            |     |
| 06.01.05 Blue-system buis                | 130 |
| <b>06.02 Fittingen voor Blue-system</b>  |     |
| 06.02.05 Blue-system fittingen           | 130 |
| <b>06.03 Afsluiters voor Blue-system</b> |     |
| 06.02.05 Blue-system afsluiters          | 132 |
| <b>06.04 Toebehoren voor Blue-system</b> |     |
| 19.01.05 Lijm en reiniger                | 132 |

## 07. Binnen- en buitenriolering

|   |     |
|---|-----|
| <b>07.01 Afvoerbuis voor binnen- en buitenriolering</b> |     |
| 07.01.05 PVC Afvoerbuis grijs                           | 134 |
| 07.01.10 PVC Afvoerbuis roodbruin                       | 134 |
| 07.01.20 PVC Regenwaterafvoerbuis                       | 135 |
| 07.01.25 PP Afvoerbuis                                  | 135 |
| <b>07.02 Binnenriolering</b>                            |     |
| 07.02.05 PVC Afvoer lijmhulpstukken                     | 136 |
| 07.02.10 PVC Doorvoerbochten                            | 139 |
| 07.02.15 Vloerputten en toebehoren                      | 141 |
| 07.02.20 PP Afvoer manchethulpstukken                   | 142 |
| <b>07.03 Buitenriolering</b>                            |     |
| 07.03.05 PVC Afvoer manchethulpstukken SN4              | 144 |
| 07.03.10 PVC Afvoer manchethulpstukken SN8              | 148 |
| 07.03.15 PVC Regenwaterafvoer hulpstukken               | 150 |
| 07.03.20 PVC Ontluchtingskappen                         | 152 |
| 07.03.25 PVC Straat- en trottoirkolken                  | 153 |
| 19.01.05 Lijm en reiniger voor afvoerleiding            | 155 |
| 07.03.40 Flexkoppelingen                                | 156 |
| <b>07.04 Drainage</b>                                   |     |
| 07.04.05 PE Drainagebuis                                | 157 |
| 07.04.10 Drainage hulpstukken                           | 158 |
| 07.04.15 PVC Drainageputten                             | 158 |
| <b>07.05 Geberit PE Afvoersysteem</b>                   |     |
| 07.05.05 Geberit PE afvoerbuis                          | 160 |
| 07.05.10 Geberit PE afvoerhulpstukken                   | 160 |

## 08. Kabelbescherming en telecom

|   |     |
|---|-----|
| <b>08.01 Kabelbescherming</b>             |     |
| 08.01.05 PE Kabelbescherming              | 168 |
| 08.01.10 PVC Kabelbescherming             | 169 |
| 08.01.15 Toebehoren voor kabelbescherming | 170 |
| <b>08.02 Telecom</b>                      |     |
| 08.02.05 Telecom                          | 171 |
| 08.02.10 Toebehoren voor telecom          | 172 |

## 09. Milieu programma

|  |     |
|--|-----|
| <b>09.01 PE Inspectie- en pompputten</b>             |     |
| 09.01.05 PE Inspectie- en pompputten                 | 174 |
| 09.02.05 Putafdekkingen                              | 175 |
| 09.03.05 Toebehoren voor PE inspectie- en pompputten | 176 |
| <b>09.02 PE Kolken</b>                               |     |
| 09.01.15 PE Kolken                                   | 177 |
| 09.02.10 Kolkafdekkingen                             | 178 |
| 09.03.05 Toebehoren voor kolken                      | 178 |
| <b>09.03 Peilputten</b>                              |     |
| 09.01.20 Peilputten                                  | 179 |
| 09.02.15 Peilputafdekkingen                          | 179 |
| 09.03.05 Toebehoren voor peilputten                  | 179 |
| <b>09.04 Infiltratie programma</b>                   |     |
| 09.04.15 Infiltratie units                           | 180 |
| <b>09.05 PE Afvoergoten en toebehoren</b>            |     |
| 09.05.10 PE Afvoergoten en toebehoren                | 181 |
| <b>09.06 Hydranten</b>                               |     |
| 09.06.05 Hydranten                                   | 182 |

## 10. Tanks

|  |     |
|--|-----|
| <b>10.01 Tanks, bovengronds en ondergronds</b> |     |
| 10.01.05 Bovengrondse opslagtanks              | 186 |
| 10.01.05 Ondergrondse tanks                    | 187 |
| <b>10.02 Toebehoren voor tanks</b>             |     |
| 10.02.05 Tanks toebehoren                      | 188 |

## 11. Folie en geotextielen

|                                    |     |
|------------------------------------|-----|
| <b>11.01 Folie en geotextielen</b> |     |
| 11.01.05 Folie en geotextielen     | 190 |

## 12. Halffabrikaten

|                                  |     |
|----------------------------------|-----|
| <b>12.01 Halffabrikaten buis</b> |     |
| 12.01.05 PVC / PP Fittingbuis    | 194 |
| 12.01.05 PVC Holstaf / Volstaf   | 194 |
| <b>12.02 Kunststof platen</b>    |     |
| 12.02.05 Kunststof platen        | 195 |
| <b>12.03 Acrylaat producten</b>  |     |
| 12.03.05 Acrylaat buis           | 196 |

## 13. RVS Programma

|  |                                    |
|--|------------------------------------|
| <b>13.01 RVS Buis</b>                      |                                    |
| 13.01.05 RVS Buis                          | 200                                |
| <b>13.02 Fittingen voor RVS leidingen</b>  | <a href="#">zie ook Beeldindex</a> |
| 13.02.05 RVS Draadfittingen                | 201                                |
| 13.02.10 RVS Lasfittingen                  | 205                                |
| <b>13.03 Afsluiters voor RVS leidingen</b> | <a href="#">zie ook Beeldindex</a> |
| 13.03.05 RVS Kogelkranen                   | 206                                |
| 13.03.05 RVS Terugslagkleppen              | 206                                |
| 13.03.05 RVS Schuifafsluiters              | 206                                |



## 14. Malleable programma

|                                       |     |
|---------------------------------------|-----|
| <b>14.01 Verzinkte buis</b>           |     |
| 14.01.05 Verzinkte buis               | 208 |
| <b>14.02 Malleable fittingen</b>      |     |
| 14.02.05 Verzinkte fittingen          | 208 |
| 14.02.10 Zwarte fittingen             | 213 |
| 14.02.15 Verzinkte pijpnippels        | 213 |
| 14.02.20 Zwarte pijpnippels           | 213 |
| 14.02.25 Stalen lasbochten            | 215 |
| 14.02.30 Verzinkte trekvast fittingen | 215 |

## 15. Sanitair en verwarming

|  |     |
|--|-----|
| <b>15.01 Buis voor sanitair en verwarming</b>          |     |
| 15.01.05 Koperen- en Wicu buis                         | 218 |
| 15.01.10 PE Flexibele mantelbuis                       | 218 |
| <b>15.02 Fittingen voor sanitair en verwarming</b>     |     |
| 15.02.05 Messing knelfittingen                         | 218 |
| 15.02.10 Messing draadfittingen                        | 220 |
| 15.02.15 Messing soldeerfittingen                      | 222 |
| <b>15.03 Armaturen voor sanitair en verwarming</b>     |     |
| 15.03.05 Messing armaturen voor sanitair en verwarming | 224 |

## 16. Metalen appendages en fittingen

|  |                                    |
|--|------------------------------------|
| <b>16.01 Fucoli programma</b>                      | <a href="#">zie ook Beeldindex</a> |
| 16.01.05 Gietijzeren afsluiters                    | 226                                |
| 16.01.10 Toebehoren voor gietijzeren afsluiters    | 228                                |
| 16.01.10 Gietijzeren balkeerklappen                | 228                                |
| 16.01.10 Gietijzeren vlinderklappen                | 229                                |
| 16.01.10 Straatpotten en toebehoren                | 230                                |
| 16.01.10 Gietijzeren fittingen                     | 231                                |
| 16.01.10 Brandkranen                               | 241                                |
| <b>16.02 PSI Programma</b>                         | <a href="#">zie ook Beeldindex</a> |
| 16.02.05 PSI Pakkingen, afdichtingen en Petro-band | 242                                |
| 16.02.05 PSI Link-Seal afsluitschakel              | 243                                |
| <b>16.03 Metalen appendages</b>                    | <a href="#">zie ook Beeldindex</a> |
| 16.03.05 Messing verchromde kogelkranen            | 245                                |
| 16.03.10 Messing/bronzen schuifafsluiters          | 246                                |
| 16.03.15 Messing terugslagklappen                  | 247                                |
| 16.03.20 Compensatoren                             | 247                                |
| 16.03.30 Metalen appendages overig                 | 248                                |
| <b>16.04 Mano-, vacuüm- en watermeters</b>         |                                    |
| 16.04.05 Mano- en vacuümmeters                     | 249                                |
| 16.04.10 Watermeters                               | 251                                |
| 16.04.10 Toebehoren watermeters                    | 252                                |

## 17. Slangen en koppelingen

|   |     |
|---|-----|
| <b>17.01 Slangen</b>                                |     |
| 17.01.05 Slangen                                    | 254 |
| <b>17.02 Appendages en koppelingen voor slangen</b> |     |
| 17.02.03 Slangklemmen                               | 256 |
| 17.02.05 Messing koppelingen Type Geka              | 257 |
| 17.02.10 Messing slangtules                         | 258 |
| 17.02.15 Sproeiappendages                           | 259 |
| 17.02.20 Storz koppelingen lichtmetaal              | 260 |
| 17.02.25 Koppelingen Type Camlock                   | 261 |

## 18. Pompen, filters en kabel

|                                |     |
|--------------------------------|-----|
| <b>18.01 Pompen</b>            |     |
| 18.01.05 Pompen                | 264 |
| <b>18.02 Mazzei injectoren</b> |     |
| 18.02.05 Mazzei injectoren     | 265 |
| <b>18.03 Arkal programma</b>   |     |
| 18.03.05 Arkal programma       | 265 |
| <b>18.04 Kabel</b>             |     |
| 18.04.05 Kabel                 | 266 |

## 19. Lijm, reiniger en toebehoren

|   |     |
|---|-----|
| <b>19.01 Lijm, reiniger en afdichtingsmateriaal</b> |     |
| 19.01.05 Lijm                                       | 268 |
| 19.01.05 Reiniger                                   | 269 |
| 19.01.10 Afdichtingsmateriaal                       | 270 |
| <b>19.02 Tape en toebehoren</b>                     |     |
| 19.02.05 Tape en toebehoren                         | 271 |

## 20. Bevestigingsmaterialen

|  |     |
|--|-----|
| <b>20.01 Bouten, moeren en sluitringen</b>       |     |
| 20.01.05 Verzinkte bouten, moeren en sluitringen | 274 |
| 20.01.10 RVS Bouten, moeren en sluitringen       | 275 |
| <b>20.02 Beugels en toebehoren</b>               |     |
| 20.02.05 Kunststof beugels                       | 276 |
| 20.02.10 Flamco beugels                          | 277 |
| 20.02.15 Stalen beugels                          | 277 |
| 20.02.15 Zware industriebeugels                  | 278 |
| 20.02.20 Toebehoren voor beugels                 | 279 |
| <b>20.03 Kabelbinders</b>                        |     |
| 20.03.05 Kabelbinders                            | 280 |

## 21. Machines en gereedschappen

|  |                                    |
|--|------------------------------------|
| <b>21.01 Machines</b>                    | <a href="#">zie ook Beeldindex</a> |
| 21.01.05 Lasmachines                     | 282                                |
| 21.01.05 Lasspiegels                     | 284                                |
| <b>21.02 Lasprocedures en toebehoren</b> | <a href="#">zie ook Beeldindex</a> |
| 21.02.05 Buisschrappers                  | 285                                |
| 21.02.05 Buissnijders                    | 286                                |
| 21.02.05 Buisklemmen sets                | 287                                |
| 21.02.05 Rondingsklemmen sets            | 288                                |
| 21.02.05 Gatzagen voor aanboorzadels     | 289                                |
| 21.02.05 Lasföhns                        | 289                                |
| <b>21.03 Gereedschappen</b>              |                                    |
| 21.03.05 Gatzagen                        | 290                                |
| 21.03.05 Plasson gereedschappen          | 291                                |
| 21.03.05 Gereedschappen overig           | 291                                |

|                             |     |
|-----------------------------|-----|
| <b>21.04 Buisafsluiters</b> |     |
| 21.04.05 Buisafsluiters     | 292 |

## Alfabetische index

|  |     |
|--|-----|
| <b>Alfabetische index</b>                        | 294 |
| <b>Algemene verkoop- en leveringsvoorwaarden</b> | 296 |

# Beeldindex

PE Drukleidingen > PVC Drukleidingen > PP Drukleidingen  
> Afstandbediende afsluiters > C-PVC Programma >  
Blue-system programma > Binnen- en buitenriolering  
> Kabelbescherming en telecom > Milieu programma  
> Tanks > Folie en geotextielen > Halffabrikaten >  
RVS Programma > Malleable programma > Sanitair  
en verwarming > Metalen appendages en fittingen >  
Slangen en koppelingen > Pompen, filters en kabel  
> Lijm, reiniger en toebehoren > Bevestigingsmaterialen >  
Machines en gereedschappen

**Milder**

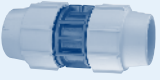







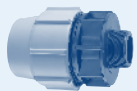
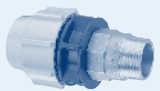

















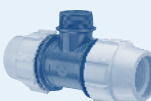
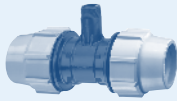


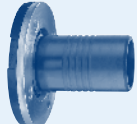



— VEELZIJDIG IN LEIDINGSYSTEMEN —



# Beeldindex 01.02 Fittingen voor PE drukleidingen

## Plasson klemfittingen



|  |   |   |   |  |
|--|---|---|---|--|
| <p><b>7010</b> blz. 27<br/>Rechte koppeling</p>                 | <p><b>17010</b> blz. 27<br/>Rechte koppeling</p>                   | <p><b>7610</b> blz. 27<br/>Reparatiekoppeling</p>                  | <p><b>17610</b> blz. 27<br/>Overschuif/reparatiekoppeling</p>         | <p><b>1761Q</b> blz. 27<br/>Overschuif/reparatiekoppeling</p>           |
| <p><b>7110</b> blz. 28<br/>Verlooppkoppeling</p>                | <p><b>7120</b> blz. 28<br/>Eindkoppeling</p>                       | <p><b>7030</b> blz. 28<br/>Overgangskoppeling binnendraad</p>      | <p><b>7020</b> blz. 28<br/>Overgangskoppeling buitendraad</p>         | <p><b>7720</b> blz. 28<br/>Overgangskoppeling messing buitendraad</p>   |
| <p><b>7510</b> blz. 28<br/>Verloepknie</p>                      | <p><b>7050</b> blz. 29<br/>Knie 90°</p>                            | <p><b>17050</b> blz. 29<br/>Knie 90°</p>                           | <p><b>7770</b> blz. 29<br/>Overgangsknie 90° messing buitendraad</p>  | <p><b>7150</b> blz. 29<br/>Overgangsknie 90° binnendraad</p>            |
| <p><b>7850</b> blz. 29<br/>Overgangsknie 90° buitendraad</p>  | <p><b>7460</b> blz. 29<br/>Knie 45°</p>                          | <p><b>7450</b> blz. 29<br/>Overgangsknie 45° buitendraad</p>     | <p><b>7350</b> blz. 29<br/>Knie-aansluiting 90° spie</p>            | <p><b>7750</b> blz. 30<br/>Muurplaat</p>                              |
| <p><b>7040</b> blz. 30<br/>T-stuk 90°</p>                     | <p><b>17040</b> blz. 30<br/>T-stuk 90°</p>                       | <p><b>7045</b> blz. 30<br/>Reparatie T-stuk 90°</p>              | <p><b>7340</b> blz. 30<br/>Verloop T-stuk 90°</p>                   | <p><b>7740</b> blz. 30<br/>Verloop T-stuk 90°</p>                     |
| <p><b>7640</b> blz. 30<br/>T-stuk 45°</p>                     | <p><b>7140</b> blz. 30<br/>Overgangs T-stuk 90° binnendraad</p>  | <p><b>7840</b> blz. 30<br/>Overgangs T-stuk 90° buitendraad</p>  | <p><b>7810</b> blz. 31<br/>Overgangs T-stuk 90° buitendraad</p>     | <p><b>7220</b> blz. 31<br/>E-stuk</p>                                 |
| <p><b>17220</b> blz. 31<br/>E-stuk</p>                        | <p><b>7236</b> blz. 31<br/>Flensaansluitstuk</p>                 | <p><b>7540</b> blz. 31<br/>Kruisstuk</p>                         | <p><b>7550</b> blz. 31<br/>Y-stuk</p>                               | <p><b>7250</b> blz. 31<br/>Draadverloop wartelmoer x buitendraad</p>  |

## Plasson klemfittingen

**PLASSON**



## Plasson PP draadfittingen



## PP Aanboorzadels



# Beeldindex 01.02 Fittingen voor PE drukleidingen

## Plasson Serie 1



|   |  |   |   |   |
|---|--|---|---|---|
| <b>10010</b> blz. 37<br>Rechte koppeling<br>                           | <b>10110</b> blz. 37<br>Verlopkoppeling<br>                           | <b>10120</b> blz. 37<br>Eindkoppeling<br>                                    | <b>10030</b> blz. 37<br>Overgangskoppeling<br>binnendraad<br>         | <b>1003G</b> blz. 37<br>Overgangskoppeling<br>rechte binnendraad<br>   |
| <b>10020</b> blz. 37<br>Overgangskoppeling<br>buitendraad<br>          | <b>10730</b> blz. 37<br>Overgangskoppeling<br>messing binnendraad<br> | <b>1073G</b> blz. 37<br>Overgangskoppeling<br>rechte messing binnendraad<br> | <b>10720</b> blz. 38<br>Overgangskoppeling<br>messing buitendraad<br> | <b>1001C</b> blz. 38<br>Overgangskoppeling<br>PE x koper<br>           |
| <b>1002C</b> blz. 38<br>Overgangskoppeling<br>koper x buitendraad<br>  | <b>1003C</b> blz. 38<br>Overgangskoppeling<br>koper x binnendraad<br> | <b>10017</b> blz. 38<br>Overgangskoppeling<br>universeel<br>                 | <b>1001Q</b> blz. 38<br>Overgangskoppeling<br>PE x PVC<br>            | <b>1001QQ</b> blz. 38<br>Rechte koppeling<br>voor PVC<br>              |
| <b>10050</b> blz. 38<br>Knie 90°<br>                                 | <b>10510</b> blz. 38<br>Verlopknie 90°<br>                          | <b>10150</b> blz. 39<br>Overgangsknie 90°<br>binnendraad<br>               | <b>10850</b> blz. 39<br>Overgangsknie 90°<br>buitendraad<br>        | <b>10760</b> blz. 39<br>Overgangsknie 90°<br>messing binnendraad<br> |
| <b>10770</b> blz. 39<br>Overgangsknie 90°<br>messing buitendraad<br> | <b>10060</b> blz. 39<br>Knie 45°<br>                                | <b>10450</b> blz. 39<br>Overgangsknie 45°<br>messing buitendraad<br>       | <b>10750</b> blz. 39<br>Muurplaat<br>                               | <b>10040</b> blz. 40<br>T-stuk 90°<br>                               |
| <b>10340</b> blz. 40<br>Verloop T-stuk 90°<br>                       | <b>10140</b> blz. 40<br>Overgangs T-stuk 90°<br>binnendraad<br>     | <b>34100</b> blz. 40<br>Stopkraan<br>                                      | <b>3410C</b> blz. 40<br>Stopkraan<br>PE x koper<br>                 | <b>35891</b> blz. 40<br>Koppeling 2-delig<br>                        |
| <b>10990</b> blz. 40<br>Demontagesleutel<br>                         |  |   |   |   |

## Plasson elektrolasfittingen



|  |  |  |   |   |
|--|--|--|---|---|
| <p><b>9010</b> blz. 41<br/>Mof</p>                                       | <p><b>9110</b> blz. 41<br/>Verloopsok</p>                                | <p><b>9050</b> blz. 41<br/>Knie 90°</p>                                  | <p><b>9060</b> blz. 41<br/>Knie 45°</p>                                   | <p><b>9080</b> blz. 41<br/>Knie 22,5°</p>                                 |
| <p><b>9120</b> blz. 42<br/>Eindkap</p>                                   | <p><b>947C</b> blz. 42<br/>Flexibele koppeling<br/>2 x mof</p>           | <p><b>947D</b> blz. 42<br/>Flexibele koppeling<br/>mof x spie</p>        | <p><b>9040</b> blz. 42<br/>T-stuk 90°</p>                                 | <p><b>9140</b> blz. 42<br/>Verloop T-stuk 90°</p>                         |
| <p><b>9940</b> blz. 43<br/>T-stuk 90°<br/>flensaftakking</p>             | <p><b>9240</b> blz. 43<br/>Dubbel T-stuk</p>                             | <p><b>9090</b> blz. 43<br/>180° Knie</p>                                 | <p><b>9770</b> blz. 43<br/>Overgangskoppeling</p>                         | <p><b>9190</b> blz. 43<br/>Y-verloopstuk</p>                              |
| <p><b>9710</b> blz. 43<br/>Overgangskoppeling<br/>PE buitendraad</p>     | <p><b>9750</b> blz. 44<br/>Overgangsknie 90°<br/>PE buitendraad</p>      | <p><b>9760</b> blz. 44<br/>Overgangsknie 45°<br/>PE buitendraad</p>      | <p><b>9210</b> blz. 44<br/>Overgangskoppeling<br/>messing buitendraad</p> | <p><b>9310</b> blz. 44<br/>Overgangskoppeling<br/>messing binnendraad</p> |
| <p><b>9250</b> blz. 44<br/>Overgangsknie 90°<br/>messing buitendraad</p> | <p><b>9350</b> blz. 44<br/>Overgangsknie 90°<br/>messing binnendraad</p> | <p><b>9360</b> blz. 45<br/>Overgangsknie 45°<br/>messing binnendraad</p> | <p><b>9260</b> blz. 45<br/>Overgangsknie 45°<br/>messing buitendraad</p>  | <p><b>9410</b> blz. 45<br/>Overgangskoppeling<br/>messing binnendraad</p> |
| <p><b>9450</b> blz. 45<br/>Overgangsknie 90°<br/>messing binnendraad</p> | <p><b>9460</b> blz. 45<br/>Overgangsknie 45°<br/>messing binnendraad</p> | <p><b>9461</b> blz. 45<br/>Overgangsknie 45°<br/>messing buitendraad</p> |   |   |

# Beeldindex 01.02 Fittingen voor PE drukleidingen

## Plasson elektrolas aanboorzadels



## Plasson elektrolasfittingen voor riooltoepassingen



## Plasson elektrolasfittingen hydranten



## Lasmachines

**3523** blz. 282  
Lastrafo PF Monomatic



**3527** blz. 282  
Lastrafo PF Polymatic Plus USB



**3529** blz. 283  
Lastrafo PF PolyControl Plus



**3530** blz. 283  
Lastrafo PF PolyCode USB



## Buisschrappers

**3314** blz. 285  
Buisschraper 125



**33142** blz. 285  
Buisschraper 200



**33143** blz. 285  
Buisschraper 315



**33144** blz. 285  
Buisschraper 400



**33148** blz. 285  
Buisschraper 800



## Gereedschappen voor aanboorzadels grote diameters

**3320** blz. 286  
Buisschraper 230V



**33170** blz. 287  
Klemmen set



**33172** blz. 287  
Klemmen set deelbaar



**33190** blz. 289  
Gatzaag set elektrolas aanboorzadel



**33192** blz. 289  
Gatzaag voor aanboorzadel 2"

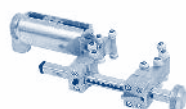


## Buissnijders

**33180** blz. 286  
Buissnijder



**33281** blz. 286  
Buissnijder 125



**33283** blz. 286  
Buissnijder 315



## Buisklemmen sets

**33311** blz. 287  
Buisklemmen set 32-110



**33342** blz. 287  
Buisklemmen set 63-200



**33325** blz. 287  
Buisklemmen set 110-560



**33338** blz. 287  
Buisklemmen set 250-800

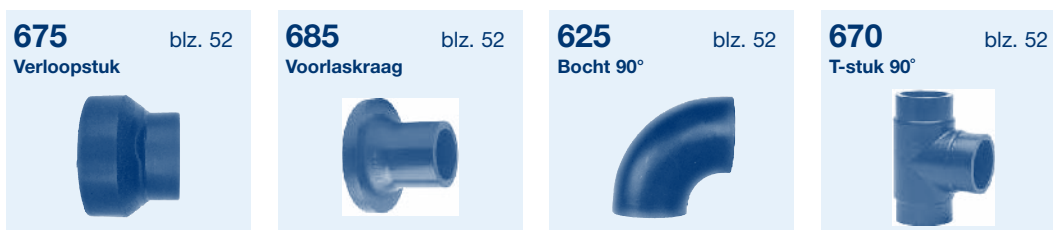


# Beeldindex 01.02 Fittingen voor PE drukleidingen

## PE Drukfittingen SDR17 met lange spie-einden



## PE Drukfittingen SDR17 kort model



## PE Drukfittingen SDR17 r=1,5d



## PP Flenzen voor PE leidingen



## PE Drukfittingen SDR11 met lange spie-einden



## PE Drukfittingen SDR11 kort model



## PE Drukfittingen SDR11 r=1,5d



## PP Flenzen voor PE leidingen





# Beeldindex 01.03 Afsluiters voor PE drukleidingen

## Plasson PE/PP afsluiters



**3703** blz. 67  
Kogelkraan glasvezel versterkt  
2 x binnendraad



**3625** blz. 67  
PE Kogelkraan



**3405** blz. 68  
PP Schuifafsluiter  
2 x cilindrisch binnendraad



**3407** blz. 68  
Stopkraan  
2 x klemkoppeling



**3046** blz. 68  
Vrijstroomafsluiter  
2 x klemkoppeling



**3047** blz. 68  
Vrijstroomafsluiter  
2 x buitendraad



**3048** blz. 68  
Vrijstroomafsluiter  
klem x buitendraad



**3049** blz. 68  
Vrijstroomafsluiter  
2 x buitendraad



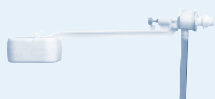
**3039** blz. 68  
Snelkoppelventiel



**3139** blz. 68  
Insteeksleutel



**3300** blz. 68  
Plasson vlotter



**3067** blz. 68  
PP Terugslagklep  
2 x buitendraad



## Plasson PP lagedruk afsluiters

**3010** blz. 69  
Mini afsluiter PN4  
klem x buitendraad



**3011** blz. 69  
Mini afsluiter PN4  
klem x binnendraad



**3012** blz. 69  
Mini afsluiter PN4  
buitendraad x binnendraad



**3013** blz. 69  
Mini afsluiter PN4  
slangkoppeling x binnendraad



**3016** blz. 69  
Mini afsluiter PN4  
slangtule x binnendraad



**3017** blz. 69  
Mini afsluiter PN4  
klem x klem



## Overige PP afsluiters

**1225** blz. 70  
Kogelkraan



**1231** blz. 70  
Mofias kogelkraan



**1226** blz. 70  
Membranaafsluiter



**1227** blz. 71  
Membranaafsluiter  
met flensaansluiting



**6308** blz. 71  
Terugslagklep



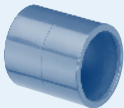
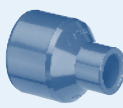
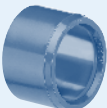
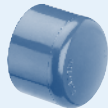




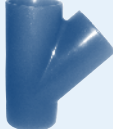
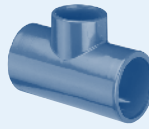


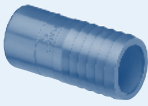
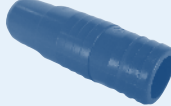
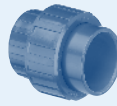
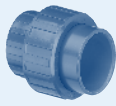


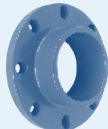




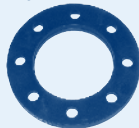
**1228** blz. 71  
Terugslagklep



**1229** blz. 71  
Vienderklep



## PVC Drukfittingen met lijmverbinding

|   |  |   |  |  |
|---|--|---|--|--|
| <b>5010</b><br>Sok<br>blz. 77<br>                                    | <b>5020</b><br>Verloopstuk<br>spie x mof x mof<br>blz. 77<br> | <b>5090</b><br>Verlooping<br>spie x mof<br>blz. 77<br>         | <b>5070</b><br>Afsluitkap<br>blz. 78<br>                          | <b>5050</b><br>Knie 90°<br>blz. 78<br>                            |
| <b>5450</b><br>Knie 45°<br>blz. 78<br>                               | <b>5550</b><br>Bocht 90°<br>blz. 78<br>                       | <b>5040</b><br>T-stuk 90°<br>blz. 78<br>                       | <b>5141</b><br>T-stuk 45°<br>blz. 78<br>                          | <b>5140</b><br>Verloop T-stuk 90°<br>blz. 79<br>                  |
| <b>5554</b><br>Kruisstuk 90°<br>blz. 79<br>                          | <b>5555</b><br>Y-stuk<br>blz. 79<br>                          | <b>5360</b><br>Slangtule<br>spie x pilaar<br>blz. 79<br>       | <b>5358</b><br>Slangtule<br>conisch<br>blz. 79<br>                 | <b>5080</b><br>3-Delige koppeling<br>EPDM O-ringen<br>blz. 80<br> |
| <b>5980</b><br>3-Delige koppeling<br>Viton O-ringen<br>blz. 80<br> | <b>5520</b><br>Kraagbus gerild<br>blz. 80<br>               | <b>5521</b><br>Verloopkraagbus<br>mof x flens<br>blz. 80<br> | <b>5920</b><br>Flens met kraagbus<br>blz. 80<br>                | <b>5629</b><br>EPDM Pakking<br>blz. 80<br>                      |
| <b>5630</b><br>FPM (viton) pakking<br>blz. 80<br>                  | <b>5900</b><br>PVC Overschuifflens<br>blz. 89<br>           | <b>5911</b><br>PVC Blindflens<br>blz. 90<br>                 | <b>5903</b><br>PP Overschuifflens<br>stalen kern<br>blz. 90<br> |  |

## PVC Drukfittingen met lijm-/draadverbinding

|   |   |  |  |  |
|---|---|--|--|--|
| <b>5012</b><br>Schroefbus<br>mof x binnendraad<br>blz. 81<br>  | <b>5712</b><br>Schroefbus<br>mof x binnendraad<br>blz. 81<br>  | <b>5022</b><br>Inzetschroefbus<br>spie x mof x binnendraad<br>blz. 81<br> | <b>5032</b><br>Inzetverloopsok<br>spie x binnendraad<br>blz. 81<br> | <b>5722</b><br>Inzetschroefbus<br>spie x mof x binnendraad<br>blz. 81<br> |
| <b>5031</b><br>Inlijmring<br>spie x binnendraad<br>blz. 81<br> | <b>5033</b><br>Inlijmring<br>spie x binnendraad<br>blz. 82<br> | <b>5212</b><br>Puntstuk<br>spie x mof x buitendraad<br>blz. 82<br>        | <b>5062</b><br>Puntstuk<br>spie x mof x buitendraad<br>blz. 82<br>  | <b>5222</b><br>Puntstuk<br>spie x mof x buitendraad<br>blz. 82<br>        |

# Beeldindex 02.02 Fittingen voor PVC drukleidingen

## PVC Drukfittingen met lijm-/draadverbinding

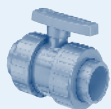


## PVC Drukfittingen met draadverbinding

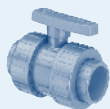


## PVC Kogelkranen

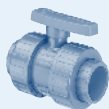
**1250** blz. 97  
Kogelkraan lijmsok  
2 x wartel EPDM O-ring



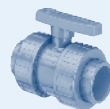
**1251** blz. 97  
Kogelkraan draadsok  
2 x wartel EPDM O-ring



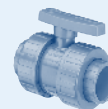
**1280** blz. 97  
Kogelkraan lijmsok  
2 x wartel FPM (viton) O-ring



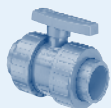
**1281** blz. 97  
Kogelkraan draadsok  
2 x wartel FPM (viton) O-ring



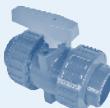
**1150** blz. 97  
Kogelkraan lijmsok  
2 x wartel EPDM O-ring



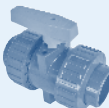
**1151** blz. 97  
Kogelkraan draadsok  
2 x wartel EPDM O-ring



**1410** blz. 97  
Kogelkraan lijmsok  
2 x wartel EPDM O-ring



**1490** blz. 97  
Kogelkraan lijmsok  
2 x wartel FPM (viton) O-ring



**1350** blz. 98  
Kogelkraan lijmsok  
1 x wartel EPDM O-ring



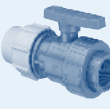
**1351** blz. 98  
Kogelkraan  
BSP binnendraad 1 x wartel  
EPDM O-ring



**1361** blz. 98  
Kogelkraan  
binnendraad x buitendraad  
1 x wartel EPDM O-ring



**1379** blz. 98  
Kogelkraan  
binnendraad x PE klem



**6300** blz. 98  
3-Weg kogelkraan  
L-boring lijmmof 3 x wartel  
EPDM O-ring



**63001** blz. 98  
3-Weg kogelkraan  
T-boring lijmmof 3 x wartel  
EPDM O-ring

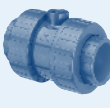


## PVC Terugslagkleppen

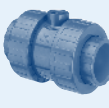
**1060** blz. 99  
Terugslagklep  
2 x lijmmof EPDM O-ring



**1000** blz. 99  
Terugslagklep  
2xlijmmofFPM(viton)O-ring



**1640** blz. 99  
Terugslagklep  
2 x lijmmof EPDM O-ring



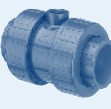
**1660** blz. 98  
Vuilvanger  
2 x lijmmof  
EPDM O-ring



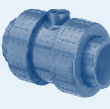
**1661** blz. 98  
Vuilvanger  
3-delige koppeling  
EPDM O-ring



**1600** blz. 99  
Terugslagklep  
2 x lijmmof FPM (viton) O-ring



**1080** blz. 99  
Terugslagklep  
EPDM O-ring



**1650** blz. 99  
Terugslagklep  
2 x lijmmof EPDM O-ring



## PVC Vlinderkleppen

**1651** blz. 99  
Terugslagklep  
2 x lijmmof 3 delige kop-  
peling EPDM O-ring



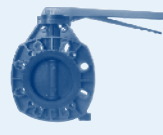
**5048** blz. 99  
Terugslagklep  
volle doorlaat



**6308** blz. 99  
PP Terugslagklep



**6302** blz. 100  
Vlinderklep



## Overige afsluiters

**1630** blz. 100  
PVC Be- en ontluichtings-  
ventiel  
2 x lijmmof EPDM O-ring



**6317** blz. 100  
PVC Laboratoriumkraan  
binnendraad x buitendraad



**6319** blz. 100  
PVC Schuifafsluiter  
2 x lijmmof






**1400** blz. 100  
PVC Membraanafsluiter  
2 x spie



**1300** blz. 100  
6-Weg spoelklep Ocean V6



## RVS Draadfittingen en RVS afsluiters

|  |  |  |   |  |
|--|--|--|---|--|
| <p><b>323</b> blz. 201<br/><b>Lassok</b><br/>2 x binnendraad</p>                | <p><b>324</b> blz. 201<br/><b>Halve sok</b><br/>1 x binnendraad</p>             | <p><b>431</b> blz. 201<br/><b>Dubbele nippel</b><br/>2 x buitendraad</p>        | <p><b>311</b> blz. 201<br/><b>Draadnippel</b><br/>buitendraad</p>               | <p><b>312</b> blz. 201<br/><b>Pijpnippel</b><br/>2 x buitendraad (BSP)</p>                |
| <p><b>313</b> blz. 201<br/><b>Lasnippel</b><br/>1 x buitendraad</p>             | <p><b>441</b> blz. 202<br/><b>Verlooping</b><br/>buitendraad x binnendraad</p>  | <p><b>451</b> blz. 202<br/><b>Verloopnippel</b><br/>2 x buitendraad</p>         | <p><b>442</b> blz. 202<br/><b>Verloopsok</b><br/>2 x binnendraad</p>            | <p><b>463</b> blz. 202<br/><b>Eindkap zeskant</b><br/>binnendraad</p>                     |
| <p><b>452</b> blz. 203<br/><b>Plug zes-/achtkant</b><br/>buitendraad</p>        | <p><b>433</b> blz. 203<br/><b>Plug vierkant</b><br/>buitendraad</p>             | <p><b>411</b> blz. 203<br/><b>Knie 90°</b><br/>2 x binnendraad</p>              | <p><b>411</b> blz. 203<br/><b>Verloopknie 90°</b><br/>2 x binnendraad</p>       | <p><b>414</b> blz. 203<br/><b>Knie 90°</b><br/>binnendraad x buitendraad</p>              |
| <p><b>322</b> blz. 203<br/><b>Bocht 90°</b><br/>2 x buitendraad</p>           | <p><b>413</b> blz. 203<br/><b>Knie 45°</b><br/>2 x binnendraad</p>            | <p><b>464</b> blz. 203<br/><b>Muurplaat 45°</b></p>                           | <p><b>465</b> blz. 204<br/><b>Muurplaat 90°</b></p>                           | <p><b>412</b> blz. 204<br/><b>T-stuk 90°</b><br/>3 x binnendraad</p>                    |
| <p><b>412</b> blz. 204<br/><b>Verloop T-stuk 90°</b><br/>3 x binnendraad</p>  | <p><b>422</b> blz. 204<br/><b>Kruisstuk 90°</b><br/>4 x binnendraad</p>       | <p><b>426</b> blz. 204<br/><b>Draadflens</b><br/>binnendraad</p>              | <p><b>421</b> blz. 204<br/><b>3-Delige koppeling</b><br/>2 x binnendraad</p>  | <p><b>423</b> blz. 204<br/><b>3-Delige koppeling</b><br/>binnendraad x buitendraad</p>  |
| <p><b>325</b> blz. 204<br/><b>Slangtule</b><br/>zeskant buitendraad</p>       | <p><b>461</b> blz. 205<br/><b>Moer</b><br/>binnendraad</p>                    | <p><b>101</b> blz. 206<br/><b>Kogelkraan 1-delig</b><br/>2 x binnendraad</p>  | <p><b>202</b> blz. 206<br/><b>Kogelkraan 2-delig</b><br/>2 x binnendraad</p>  | <p><b>216</b> blz. 206<br/><b>Kogelkraan 2-delig</b><br/>flenzen</p>                    |
| <p><b>301</b> blz. 206<br/><b>Kogelkraan 3-delig</b><br/>2 x binnendraad</p>  | <p><b>3251</b> blz. 206<br/><b>Kogelkraan 3-delig</b><br/>flenzen</p>         | <p><b>3281</b> blz. 206<br/><b>Terugslagklep</b><br/>2 x binnendraad</p>      | <p><b>3291</b> blz. 206<br/><b>Balkeerklep</b></p>                            | <p><b>3271</b> blz. 206<br/><b>Schuifafsluiter</b><br/>2 x binnendraad</p>              |

## Gietijzere afsluiters

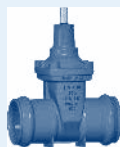
**Fig. 100** blz. 226  
Flensafsluiter F4 korte  
inbouw voor water



**Fig. 101** blz. 226  
Flensafsluiter F5 lange  
inbouw voor water



**Fig. 102** blz. 226  
Mofafsluiter  
voor water



**Fig. 103** blz. 226  
Afsluiter met PE spie-  
einden voor water



**Fig. 111** blz. 227  
Dienstafsluiter voor water  
2 x binnendraad



**Fig. 112** blz. 227  
Dienstafsluiter 90°  
voor water  
buitendraad x binnendraad



**Fig. 115** blz. 227  
Dienstafsluiter voor water  
2 x insteek PE



**Fig. 116** blz. 227  
Dienstafsluiter 90°  
voor water  
buitendraad x insteek PE



**Fig. 117** blz. 227  
Dienstafsluiter voor water  
buitendraad x insteek PE



**Fig. 124** blz. 228  
Inbouwgarneer



## Gietijzere balkeerkleppen en vlinderkleppen

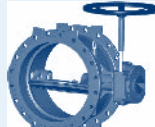
**Fig. 165** blz. 228  
Balkeerklep voor water  
2 x binnendraad



**Fig. 166** blz. 229  
Balkeerklep voor water  
flenzen



**Fig. 170** blz. 229  
Vlinderklep met GY  
zitting voor water



**Fig. 174** blz. 230  
Vlinderklep met handle  
voor water



## Straatpotten en toebehoren

**Fig. 130** blz. 230  
Afsluiter straatpot



**Fig. 130.1** blz. 230  
Tussenstuk  
ophogen straatpot



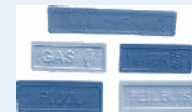
**Fig. 131** blz. 230  
Betonnen Bovenleg-  
tegel voor straatpot



**Fig. 132** blz. 230  
Kunststof Onderleg-  
tegel voor straatpot

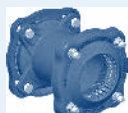


**Fig. 133** blz. 230  
Plaatje voor straatpot



## Gietijzere fittingen

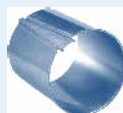
**Fig. 150** blz. 231  
Trekvast koppeling  
GFIX® voor water



**Fig. 154** blz. 231  
Trekvast E-stuk GFIX®  
voor water



**Fig. 155/255**  
RVS Steunbus blz. 231



**Fig. 157** blz. 232  
Inbouwstuk/passtuk voor  
water



**Fig. 180** blz. 232  
Aanboorzadel voor water



**Fig. 183** blz. 233  
Adapter voor GY aan-  
boorzadel



**Fig. 189** blz. 234  
Adapterflens voor water



**Fig. 300** blz. 234  
Flensbuis FF voor water



**Fig. 301** blz. 234  
Flensbuis met instort-  
flens FFM voor water



**Fig. 305** blz. 235  
Bocht 11° FFK voor water



## Beeldindex 16.01 Fucoli programma

### Gietijzeren fittingen

**Fig. 306** blz. 235  
Bocht 22° FFK voor water



**Fig. 308** blz. 235  
Bocht 45° FFK voor water



**Fig. 312** blz. 236  
Bocht 90° FFQ voor water



**Fig. 320** blz. 236  
T-stuk FFT voor water



**Fig. 325** blz. 238  
Verloopstuk FFR voor water



**Fig. 330** blz. 239  
Voetbocht voor water



**Fig. 340** blz. 239  
Blindflens voor water



**Fig. 345** blz. 239  
Draadflens voor water binnendraad



**Fig. 346** blz. 240  
½ Flens voor water



**Fig. 347** blz. 240  
½ Flens voor water ANSI B16.5



### Gietijzeren brandkranen

**Fig. 402** blz. 241  
Ondergrondse brandkraan



**Fig. 405** blz. 241  
Bovengrondse brandkraan



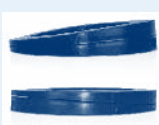
## Beeldindex 16.02 PSI Programma

### PSI Pakkingen, afdichtingen en Petro-band

**Fig. 192** blz. 242  
EPDM Pakking met staalinlage



**Fig. 195** blz. 242  
EPDM Pakking verstelbaar tot 8°



**Fig. 205** blz. 243  
NBR Pakking met staalinlage



**Fig. 220** blz. 243  
PSI Link-Seal afsluitschakel



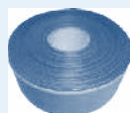
**Fig. 210** blz. 244  
Rubber instortflens muurdoorvoer



**Fig. 230** blz. 244  
Afstandhouder



**Fig. 231** blz. 244  
Bandvoorafstandhouders



**Fig. 240** blz. 244  
Kebu Petro-band



**Fig. 243** blz. 244  
Kebu Reparatieband



**Fig. 246** blz. 244  
Kebu Kneedmassa



**Fig. 247** blz. 244  
Stopaq afdichtingspasta FN2100



## Messing verchromde kogelkranen

**840** blz. 245  
Kogelkraan volle doorlaat  
2 x binnendraad



**850** blz. 245  
Kogelkraan gereduceerde doorlaat  
2 x binnendraad



**842** blz. 245  
Kogelkraan volle doorlaat  
2 x binnendraad



**841** blz. 245  
Kogelkraan met aftapper  
volle doorlaat  
2 x binnendraad



**845** blz. 245  
Kogelkraan volle doorlaat  
binnendraad x buitendraad



**300** blz. 245  
Kogelkraan volle doorlaat  
2 x binnendraad



**610** blz. 245  
Kogelkraan volle doorlaat  
2 x binnendraad



**450** blz. 245  
Kogelkraan slangwartel  
buitendraad x slangwartel



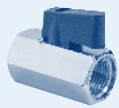
**855** blz. 246  
Kogelkraan  
gereduceerde doorlaat  
binnendraad x buitendraad



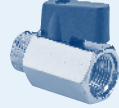
**535** blz. 246  
3-Weg kogelkraan



**400** blz. 246  
Mini kogelkraan  
2 x binnendraad



**405** blz. 246  
Mini kogelkraan  
binnendraad x buitendraad



## Messing/bronzen schuifafsluiters en terugslagkleppen

**1570** blz. 246  
Schuifafsluiter messing  
2 x binnendraad



**1600** blz. 246  
Schuifafsluiter brons/  
messing  
2 x binnendraad



**1030** blz. 247  
Terugslagklep messing  
2 x binnendraad



**1420** blz. 247  
Terugslagklep Tuxhorn  
messing  
binnendraad x buitendraad



**1500** blz. 247  
Terugslagklep messing  
1 x binnendraad



**1300** blz. 247  
Terugslagklep messing  
2 x binnendraad



## Compensatoren

**238** blz. 247  
Compensator  
binnendraad



**239** blz. 247  
Compensator  
flenzen



## Overige metalen appendages

**1421** blz. 248  
Veiligheidstoestel  
2 x binnendraad



**1422** blz. 248  
Vuilvanger  
2 x binnendraad



**1304** blz. 248  
Drukreduceerventiel  
2 x binnendraad



**1202** blz. 248  
Arion filter



**2700** blz. 248  
Dubbeldisc keerklep





**Notities**

A large light blue rectangular area with horizontal ruling lines, intended for taking notes. The lines are evenly spaced and extend across the width of the page.

# Productgroep 01

PE Drukleidingen > PVC Drukleidingen > PP Drukleidingen  
> Afstandbediende afsluiters > C-PVC Programma >  
Blue-system programma > Binnen- en buitenriolering  
> Kabelbescherming en telecom > Milieu programma  
> Tanks > Folie en geotextielen > Halffabrikaten >  
RVS Programma > Malleable programma > Sanitair  
en verwarming > Metalen appendages en fittingen >  
Slangen en koppelingen > Pompen, filters en kabel  
> Lijm, reiniger en toebehoren > Bevestigingsmaterialen >  
Machines en gereedschappen

>> PE Drukleidingen

# Milder

— VEELZIJDIG IN LEIDINGSYSTEMEN —

# 01.01 PE Drukbuĳs

## PE 100 Drukbuĳs

- Met EN 12201/DIN keur (waar van toepassing).
- Kleur: zwart.
- Voor o.a. waterleiding.
- Afwijkende uitvoeringen zijn op aanvraag leverbaar.
- Lengten: - 20 t/m 315mm, standaard 5 meter, ook leverbaar op 10 meter.  
- 355 t/m 630mm, standaard 6 meter, ook leverbaar op 12 meter.

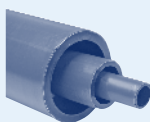
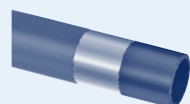
- Rollen: - 20 t/m 110mm, standaard 50 en 100 meter.  
- 125, 140 en 160mm, op 50 meter op aanvraag.
- Voor het bestellen van de gewenste lengten het volgende aan het artikelnr. toevoegen:  
... = 005 (lengte 5 meter) ... = 012 (lengte 12 meter)  
... = 006 (lengte 6 meter) ... = 050 (lengte 50 meter)  
... = 010 (lengte 10 meter) ... = 100 (lengte 100 meter)

|  | Buitendiameter<br>x wanddikte in mm | Artikelnr.             |
|--|-------------------------------------|------------------------|
| <b>1117</b><br><b>HDPE Buis</b><br>- SDR17<br>- PE 100 | 25 x 1,8                            | 1117025...             |
|  | 32 x 2,0                            | 1117032...             |
|  | 40 x 2,4                            | 1117040...             |
|  | 50 x 3,0                            | 1117050...             |
|  | 63 x 3,8                            | 1117063...             |
|  | 75 x 4,5                            | 1117075...             |
|  | 90 x 5,4                            | 1117090...             |
|  | 110 x 6,6                           | 1117110...             |
|  | 125 x 7,4                           | 1117125...             |
|  | 140 x 8,3                           | 1117140...             |
|  | 160 x 9,5                           | 1117160...             |
|  | 180 x 10,7                          | 1117180...             |
|  | 200 x 11,9                          | 1117200...             |
|  | 225 x 13,4                          | 1117225...             |
|  | 250 x 14,8                          | 1117250...             |
|  | 280 x 16,6                          | 1117280...             |
|  | 315 x 18,7                          | 1117315...             |
|  | 355 x 21,1                          | 1117355...             |
|  | 400 x 23,7                          | 1117400...             |
|  | 450 x 26,7                          | 1117450...             |
| 500 x 29,7   | 1117500...                          |                        |
| 560 x 33,2   | 1117560...                          |                        |
| 630 x 37,4   | 1117630...                          |                        |
|  |                                     | Artikelgroep: 01.01.05 |

|  | Buitendiameter<br>x wanddikte in mm | Artikelnr.             |
|--|-------------------------------------|------------------------|
| <b>1119</b><br><b>HDPE Buis</b><br>- SDR11<br>- PE 100 | 20 x 1,9                            | 1119020...             |
|  | 25 x 2,3                            | 1119025...             |
|  | 32 x 3,0                            | 1119032...             |
|  | 40 x 3,7                            | 1119040...             |
|  | 50 x 4,6                            | 1119050...             |
|  | 63 x 5,8                            | 1119063...             |
|  | 75 x 6,8                            | 1119075...             |
|  | 90 x 8,2                            | 1119090...             |
|  | 110 x 10,0                          | 1119110...             |
|  | 125 x 11,4                          | 1119125...             |
|  | 140 x 12,7                          | 1119140...             |
|  | 160 x 14,6                          | 1119160...             |
|  | 180 x 16,4                          | 1119180...             |
|  | 200 x 18,2                          | 1119200...             |
|  | 225 x 20,5                          | 1119225...             |
|  | 250 x 22,7                          | 1119250...             |
|  | 280 x 25,4                          | 1119280...             |
|  | 315 x 28,6                          | 1119315...             |
|  | 355 x 32,2                          | 1119355...             |
|  | 400 x 36,3                          | 1119400...             |
| 450 x 40,9   | 1119450...                          |                        |
| 500 x 45,4   | 1119500...                          |                        |
| 560 x 50,8   | 1119560...                          |                        |
| 630 x 57,2   | 1119630...                          |                        |
|  |                                     | Artikelgroep: 01.01.05 |

### HDPE Versterkte buĳs

Voor het leveren van HDPE versterkte buĳs (RC) en HDPE buĳs met aluminium inlage kunt u contact opnemen met onze verkoopmedewerkers.



## PE 100 Drukbuĳs voor gas

- Met Gastec QA merk (waar van toepassing).
- Lengten: standaard op 12 meter (vanaf 63mm).
- Rollen: standaard op 50 of 100 meter.

- Voor het bestellen van de gewenste lengten het volgende aan het artikelnr. toevoegen: ... = 012 (lengte 12 meter)  
... = 050 (lengte 50 meter)  
... = 100 (lengte 100 meter)

|   | Buitendiameter<br>x wanddikte in mm | Artikelnr.             |
|---|-------------------------------------|------------------------|
| <b>1101</b><br><b>HDPE Buis voor gas</b><br>- SDR17,6<br>- kleur: geel of zwart met gele streep | 25 x 2,3                            | 1101025...             |
|   | 32 x 2,3                            | 1101032...             |
|   | 40 x 2,3                            | 1101040...             |
|   | 50 x 2,9                            | 1101050...             |
|   | 63 x 3,6                            | 1101063...             |
|   | 75 x 4,3                            | 1101075...             |
|   | 90 x 5,2                            | 1101090...             |
|   | 110 x 6,3                           | 1101110...             |
|   |                                     | Artikelgroep: 01.01.20 |


Grotere diameters zijn op aanvraag leverbaar.

|   | Buitendiameter<br>x wanddikte in mm | Artikelnr.             |
|---|-------------------------------------|------------------------|
| <b>1102</b><br><b>HDPE Buis voor gas</b><br>- SDR11<br>- kleur: geel of zwart met gele streep | 25 x 3,0                            | 1102025...             |
|   | 32 x 3,0                            | 1102032...             |
|   | 40 x 3,7                            | 1102040...             |
|   | 50 x 4,6                            | 1102050...             |
|   | 63 x 5,8                            | 1102063...             |
|   | 75 x 6,9                            | 1102075...             |
|   | 90 x 8,2                            | 1102090...             |
|   | 110 x 10,0                          | 1102110...             |
|   |                                     | Artikelgroep: 01.01.20 |

Grotere diameters zijn op aanvraag leverbaar.

## ZPE Buis

- Met KIWA-keur/DIN keur (waar van toepassing).
- Rollen: standaard op 50 of 100 meter.
- Voor het bestellen van de gewenste lengten het volgende aan het artikelnr. toevoegen:  
 ... = 050 (lengte 50 meter)  
 ... = 100 (lengte 100 meter)

|   |   | Buitendiameter<br>x wanddikte in mm | Artikelnr. |
|---|---|-------------------------------------|------------|
| <b>1103</b><br><b>ZPE Buis</b><br>- PN6<br>- kleur: zwart of zwart<br>met blauwe streep |  | 16 x 1,8                            | 1103016... |
|   |   | 20 x 2,2                            | 1103020... |
|   |   | 25 x 2,7                            | 1103025... |
|   |   | 32 x 3,5                            | 1103032... |
|   |   | 40 x 4,3                            | 1103040... |
|   |   | 50 x 5,4                            | 1103050... |
|   |   | 63 x 6,8                            | 1103063... |
|   |   |                                     |            |

## Fittingen voor PE drukleidingen 01.02

### Plasson klemfittingen




- Klemfittingen met KIWA-keur (waar van toepassing).

|   | Afmeting in mm         | Artikelnr. |
|---|------------------------|------------|
| <b>7010</b><br><b>Rechte koppeling</b><br> | 16 *                   | 7010016    |
|   | 20 *                   | 7010020    |
|   | 25 *                   | 7010025    |
|   | 32 *                   | 7010032    |
|   | 40 *                   | 7010040    |
|   | 50 *                   | 7010050    |
|   | 63 *                   | 7010063    |
|   | 75                     | 7010075    |
|   | 90                     | 7010090    |
|   | 110                    | 7010110    |
|   | 125                    | 7010125    |
|   | Artikelgroep: 01.02.05 |            |

\* Voor rechte koppeling zonder stootrand zie groep 8 blz. 172, artikelnr. 70101.

|  | Afmeting in mm         | Artikelnr.  |
|--|------------------------|-------------|
| <b>17610</b><br><b>Overschuif/repairatie-koppeling</b><br>- universeel<br>- voor PE, PE-RC, PP, PVC-U, koper, verzinkt staal, lood | 24 - 28                | 17610024028 |
|  | 31 - 35                | 17610031035 |
|  | 40 - 43                | 17610040043 |
|  | 48 - 51                | 17610048051 |
|  | 60 - 64                | 17610060064 |
|  | Artikelgroep: 01.02.05 |             |



|  | Afmeting in mm | Artikelnr. |
|--|----------------|------------|
| <b>17010</b><br><b>Rechte koppeling</b><br> | 160            | 17010160   |
| Artikelgroep: 01.02.05   |                |            |

|   | Afmeting in mm | Artikelnr. |
|---|----------------|------------|
| <b>1761Q</b><br><b>Overschuif/repairatie-koppeling</b><br>- voor PE, PE-RC, PP, PVC-U | 25             | 1761Q025   |
|   | 32             | 1761Q032   |
| Artikelgroep: 01.02.05  |                |            |



|   | Afmeting in mm         | Artikelnr. |
|---|------------------------|------------|
| <b>7610</b><br><b>Reparatiekoppeling</b><br> | 20                     | 7610020    |
|   | 25                     | 7610025    |
|   | 32                     | 7610032    |
|   | 40                     | 7610040    |
|   | 50                     | 7610050    |
|   | 63                     | 7610063    |
|   | 75                     | 7610075    |
|   | 90                     | 7610090    |
|   | 110                    | 7610110    |
|   | 125                    | 7610125    |
|   | 160                    | 7610160    |
|   | Artikelgroep: 01.02.05 |            |

# 01.02 Fittingen voor PE drukleidingen

## Plasson klemfittingen



01

|                          | Afmeting in mm | Artikelnr. |
|--------------------------|----------------|------------|
| <b>7110</b>              | 20 x 16        | 7110020016 |
| <b>Verlooppkoppeling</b> | 25 x 16 *      | 7110025016 |
|                          | 25 x 20 *      | 7110025020 |
|                          | 32 x 20 *      | 7110032020 |
|                          | 32 x 25 *      | 7110032025 |
|                          | 40 x 25 *      | 7110040025 |
|                          | 40 x 32 *      | 7110040032 |
|                          | 50 x 25 *      | 7110050025 |
|                          | 50 x 32 *      | 7110050032 |
|                          | 50 x 40 *      | 7110050040 |
|                          | 63 x 25 *      | 7110063025 |
|                          | 63 x 32 *      | 7110063032 |
|                          | 63 x 40 *      | 7110063040 |
|                          | 63 x 50 *      | 7110063050 |
|                          | 75 x 50        | 7110075050 |
|                          | 75 x 63        | 7110075063 |
|                          | 90 x 63        | 7110090063 |
|                          | 90 x 75        | 7110090075 |
|                          | 110 x 90       | 7110110090 |

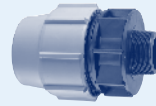
Artikelgroep: 01.02.05

\* Voor verlooppkoppeling zonder stootrand zie groep 8 blz. 172, artikelnr. 71101.



|                           | Afmeting    | Artikelnr. |
|---------------------------|-------------|------------|
| <b>7020</b>               | 16 x 3/8"   | 7020016038 |
| <b>Overgangskoppeling</b> | 16 x 1/2"   | 7020016012 |
| <b>- met buitendraad</b>  | 16 x 3/4"   | 7020016034 |
|                           | 20 x 1/2"   | 7020020012 |
|                           | 20 x 3/4"   | 7020020034 |
|                           | 20 x 1"     | 7020020100 |
|                           | 25 x 1/2"   | 7020025012 |
|                           | 25 x 3/4"   | 7020025034 |
|                           | 25 x 1"     | 7020025100 |
|                           | 32 x 3/4"   | 7020032034 |
|                           | 32 x 1"     | 7020032100 |
|                           | 32 x 1 1/4" | 7020032114 |
|                           | 32 x 1 1/2" | 7020032112 |
|                           | 40 x 1"     | 7020040100 |
|                           | 40 x 1 1/4" | 7020040114 |
|                           | 40 x 1 1/2" | 7020040112 |
|                           | 40 x 2"     | 7020040200 |
|                           | 50 x 1"     | 7020050100 |
|                           | 50 x 1 1/4" | 7020050114 |
|                           | 50 x 1 1/2" | 7020050112 |
|                           | 50 x 2"     | 7020050200 |
|                           | 63 x 1 1/4" | 7020063114 |
|                           | 63 x 1 1/2" | 7020063112 |
|                           | 63 x 2"     | 7020063200 |
|                           | 63 x 2 1/2" | 7020063212 |
|                           | 75 x 2"     | 7020075200 |
|                           | 75 x 2 1/2" | 7020075212 |
|                           | 75 x 3"     | 7020075300 |
|                           | 90 x 2"     | 7020090200 |
|                           | 90 x 2 1/2" | 7020090212 |
|                           | 90 x 3"     | 7020090300 |
|                           | 90 x 4"     | 7020090400 |
|                           | 110 x 2"    | 7020110200 |
|                           | 110 x 3"    | 7020110300 |
|                           | 110 x 4"    | 7020110400 |

Artikelgroep: 01.02.05



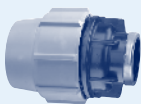
|                      | Afmeting in mm | Artikelnr. |
|----------------------|----------------|------------|
| <b>7120</b>          | 20             | 7120020    |
| <b>Eindkoppeling</b> | 25             | 7120025    |
|                      | 32             | 7120032    |
|                      | 40             | 7120040    |
|                      | 50             | 7120050    |
|                      | 63             | 7120063    |
|                      | 75             | 7120075    |
|                      | 90             | 7120090    |
|                      | 110            | 7120110    |

Artikelgroep: 01.02.05



|                           | Afmeting    | Artikelnr. |
|---------------------------|-------------|------------|
| <b>7030</b>               | 16 x 1/2"   | 7030016012 |
| <b>Overgangskoppeling</b> | 16 x 3/4"   | 7030016034 |
| <b>- met binnendraad</b>  | 20 x 1/2"   | 7030020012 |
|                           | 20 x 3/4"   | 7030020034 |
|                           | 20 x 1"     | 7030020100 |
|                           | 25 x 3/4"   | 7030025034 |
|                           | 25 x 1"     | 7030025100 |
|                           | 32 x 3/4"   | 7030032034 |
|                           | 32 x 1"     | 7030032100 |
|                           | 32 x 1 1/4" | 7030032114 |
|                           | 40 x 1"     | 7030040100 |
|                           | 40 x 1 1/4" | 7030040114 |
|                           | 40 x 1 1/2" | 7030040112 |
|                           | 50 x 1 1/4" | 7030050114 |
|                           | 50 x 1 1/2" | 7030050112 |
|                           | 50 x 2"     | 7030050200 |
|                           | 63 x 1 1/4" | 7030063114 |
|                           | 63 x 1 1/2" | 7030063112 |
|                           | 63 x 2"     | 7030063200 |
|                           | 75 x 2"     | 7030075200 |
|                           | 75 x 2 1/2" | 7030075212 |
|                           | 90 x 2"     | 7030090200 |
|                           | 90 x 3"     | 7030090300 |
|                           | 90 x 4"     | 7030090400 |
|                           | 110 x 3"    | 7030110300 |
|                           | 110 x 4"    | 7030110400 |

Artikelgroep: 01.02.05



|                                  | Afmeting    | Artikelnr. |
|----------------------------------|-------------|------------|
| <b>7720</b>                      | 32 x 3/4"   | 7720032034 |
| <b>Overgangskoppeling</b>        | 32 x 1"     | 7720032100 |
| <b>- met messing buitendraad</b> | 32 x 1 1/4" | 7720032114 |
|                                  | 32 x 1 1/2" | 7720032112 |
|                                  | 40 x 3/4"   | 7720040034 |
|                                  | 40 x 1"     | 7720040100 |
|                                  | 40 x 1 1/4" | 7720040114 |
|                                  | 40 x 1 1/2" | 7720040112 |
|                                  | 50 x 1"     | 7720050100 |
|                                  | 50 x 1 1/4" | 7720050114 |
|                                  | 50 x 1 1/2" | 7720050112 |
|                                  | 63 x 1 1/4" | 7720063114 |
|                                  | 63 x 1 1/2" | 7720063112 |
|                                  | 63 x 2"     | 7720063200 |

Artikelgroep: 01.02.05



|                         | Afmeting in mm | Artikelnr.             |
|-------------------------|----------------|------------------------|
| <b>7510</b>             | 25 x 20        | 7510025020             |
| <b>Verlooppknie 90°</b> |                | Artikelgroep: 01.02.05 |



## Plasson klemfittingen



01

|                         | Afmeting in mm | Artikelnr. |
|-------------------------|----------------|------------|
| <b>7050</b><br>Knie 90° | 16             | 7050016    |
|                         | 20             | 7050020    |
|                         | 25             | 7050025    |
|                         | 32             | 7050032    |
|                         | 40             | 7050040    |
|                         | 50             | 7050050    |
|                         | 63             | 7050063    |
|                         | 75             | 7050075    |
|                         | 90             | 7050090    |
|                         | 110            | 7050110    |



|              | Afmeting | Artikelnr. |
|--------------|----------|------------|
| <b>17050</b> | 160      | 17050160   |

Artikelgroep: 01.02.05



|  | Afmeting    | Artikelnr. |
|--|-------------|------------|
| <b>7770</b><br>Overgangsknie 90°<br>- met messing<br>buitendraad | 32 x 3/4"   | 7770032034 |
|  | 32 x 1"     | 7770032100 |
|  | 32 x 1 1/4" | 7770032114 |
|  | 32 x 1 1/2" | 7770032112 |
|  | 40 x 3/4"   | 7770040034 |
|  | 40 x 1"     | 7770040100 |
|  | 40 x 1 1/4" | 7770040114 |
|  | 40 x 1 1/2" | 7770040112 |
|  | 50 x 1"     | 7770050100 |
|  | 50 x 1 1/4" | 7770050114 |
|  | 50 x 1 1/2" | 7770050112 |
|  | 63 x 1 1/4" | 7770063114 |
|  | 63 x 1 1/2" | 7770063112 |
|  | 63 x 2"     | 7770063200 |

Artikelgroep: 01.02.05



|   | Afmeting    | Artikelnr. |
|---|-------------|------------|
| <b>7150</b><br>Overgangsknie 90°<br>- met binnendraad | 16 x 1/2"   | 7150016012 |
|   | 20 x 1/2"   | 7150020012 |
|   | 20 x 3/4"   | 7150020034 |
|   | 25 x 1/2"   | 7150025012 |
|   | 25 x 3/4"   | 7150025034 |
|   | 25 x 1"     | 7150025100 |
|   | 32 x 3/4"   | 7150032034 |
|   | 32 x 1"     | 7150032100 |
|   | 32 x 1 1/4" | 7150032114 |
|   | 40 x 1"     | 7150040100 |
|   | 40 x 1 1/4" | 7150040114 |
|   | 40 x 1 1/2" | 7150040112 |
|   | 40 x 2"     | 7150040200 |
|   | 50 x 1"     | 7150050100 |
|   | 50 x 1 1/4" | 7150050114 |
|   | 50 x 1 1/2" | 7150050112 |
|   | 50 x 2"     | 7150050200 |
|   | 63 x 1 1/4" | 7150063114 |
|   | 63 x 1 1/2" | 7150063112 |
|   | 63 x 2"     | 7150063200 |
|   | 75 x 2"     | 7150075200 |
| 75 x 2 1/2"   | 7150075212  |            |
| 75 x 3"   | 7150075300  |            |

Artikelgroep: 01.02.05



|   | Afmeting    | Artikelnr. |
|---|-------------|------------|
| <b>7850</b><br>Overgangsknie 90°<br>- met buitendraad | 20 x 1/2"   | 7850020012 |
|   | 20 x 3/4"   | 7850020034 |
|   | 25 x 1/2"   | 7850025012 |
|   | 25 x 3/4"   | 7850025034 |
|   | 25 x 1"     | 7850025100 |
|   | 32 x 1"     | 7850032100 |
|   | 32 x 1 1/4" | 7850032114 |
|   | 40 x 1"     | 7850040100 |
|   | 40 x 1 1/4" | 7850040114 |
|   | 40 x 1 1/2" | 7850040112 |
|   | 50 x 1"     | 7850050100 |
|   | 50 x 1 1/4" | 7850050114 |
|   | 50 x 1 1/2" | 7850050112 |
|   | 50 x 2"     | 7850050200 |
|   | 63 x 1 1/4" | 7850063114 |
|   | 63 x 1 1/2" | 7850063112 |
|   | 63 x 2"     | 7850063200 |
|   | 75 x 2 1/2" | 7850075212 |
|   | 75 x 3"     | 7850075300 |
|   | 90 x 3"     | 7850090300 |
|   | 110 x 4"    | 7850110400 |

Artikelgroep: 01.02.05



|                         | Afmeting in mm | Artikelnr. |
|-------------------------|----------------|------------|
| <b>7460</b><br>Knie 45° | 32             | 7460032    |
|                         | 40             | 7460040    |
|                         | 50             | 7460050    |
|                         | 63             | 7460063    |
|                         | 75             | 7460075    |
|                         | 90             | 7460090    |
|                         | 110            | 7460110    |

Artikelgroep: 01.02.05



|   | Afmeting  | Artikelnr. |
|---|-----------|------------|
| <b>7450</b><br>Overgangsknie 45°<br>- met buitendraad | 20 x 1/2" | 7450020012 |
|   | 20 x 3/4" | 7450020034 |

Artikelgroep: 01.02.05



|   | Afmeting in mm | Artikelnr. |
|---|----------------|------------|
| <b>7350</b><br>Knie-aansluiting 90°<br>- klem x spie<br>- spie-eind passend<br>in fitting | 40 x 40        | 7350040040 |
|   | 40 x 50        | 7350040050 |
|   | 50 x 40        | 7350050040 |
|   | 50 x 50        | 7350050050 |
|   | 63 x 40        | 7350063040 |
|   | 63 x 50        | 7350063050 |

Artikelgroep: 01.02.05



# 01.02 Fittingen voor PE drukleidingen

## Plasson klemfittingen




01

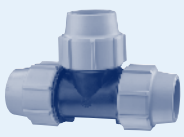
|                          | Afmeting  | Artikelnr.             |
|--------------------------|-----------|------------------------|
| <b>7750</b><br>Muurplaat | 16 x 1/2" | 7750016012             |
|                          | 20 x 1/2" | 7750020012             |
|                          | 25 x 3/4" | 7750025034             |
|                          |           | Artikelgroep: 01.02.05 |



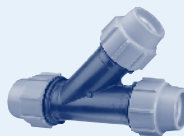
|  | Afmeting in mm | Artikelnr.             |
|--|----------------|------------------------|
| <b>7740</b><br>Verloop T-stuk 90°<br>- met grote aftakking | 25 x 32 x 25   | 7740025032             |
|  |                | Artikelgroep: 01.02.05 |



| Artikelnr.                | Afmeting in mm | Artikelnr. |
|---------------------------|----------------|------------|
| <b>7040</b><br>T-stuk 90° | 16             | 7040016    |
|                           | 20             | 7040020    |
|                           | 25             | 7040025    |
|                           | 32             | 7040032    |
|                           | 40             | 7040040    |
|                           | 50             | 7040050    |
|                           | 63             | 7040063    |
|                           | 75             | 7040075    |
|                           | 90             | 7040090    |
|                           | 110            | 7040110    |




|                           | Afmeting in mm | Artikelnr.             |
|---------------------------|----------------|------------------------|
| <b>7640</b><br>T-stuk 45° | 63             | 7640063                |
|                           | 75             | 7640075                |
|                           | 90             | 7640090                |
|                           | 110            | 7640110                |
|                           |                | Artikelgroep: 01.02.05 |




|              |     |                        |
|--------------|-----|------------------------|
| <b>17040</b> | 160 | 17040160               |
|              |     | Artikelgroep: 01.02.05 |



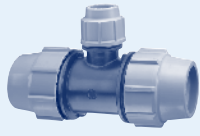
|   | Afmeting         | Artikelnr.             |
|---|------------------|------------------------|
| <b>7140</b><br>Overgangs<br>T-stuk 90°<br>- met binnendraad | 16 x 1/2" x 16   | 7140016012             |
|   | 16 x 3/4" x 16   | 7140016034             |
|   | 20 x 3/4" x 16   | 7140020034016          |
|   | 20 x 1/2" x 20   | 7140020012             |
|   | 20 x 3/4" x 20   | 7140020034             |
|   | 25 x 3/4" x 20   | 7140025034020          |
|   | 25 x 1/2" x 25   | 7140025012             |
|   | 25 x 3/4" x 25   | 7140025034             |
|   | 25 x 1" x 25     | 7140025100             |
|   | 25 x 1 1/4" x 25 | 7140025114             |
|   | 32 x 1" x 25     | 7140032100025          |
|   | 32 x 3/4" x 32   | 7140032034             |
|   | 32 x 1" x 32     | 7140032100             |
|   | 32 x 1 1/4" x 32 | 7140032114             |
|   | 32 x 1 1/2" x 32 | 7140032112             |
|   | 40 x 1" x 40     | 7140040100             |
|   | 40 x 1 1/4" x 40 | 7140040114             |
|   | 40 x 1 1/2" x 40 | 7140040112             |
|   | 40 x 2" x 40     | 7140040200             |
|   | 50 x 1 1/2" x 50 | 7140050112             |
|   | 50 x 2" x 50     | 7140050200             |
|   | 63 x 1 1/4" x 63 | 7140063114             |
|   | 63 x 1 1/2" x 63 | 7140063112             |
|   | 63 x 2" x 63     | 7140063200             |
|   | 75 x 2" x 75     | 7140075200             |
|   | 75 x 2 1/2" x 75 | 7140075212             |
|   | 75 x 3" x 75     | 7140075300             |
|   | 90 x 3" x 90     | 7140090300             |
|   | 110 x 4" x 110   | 7140110400             |
|   |                  | Artikelgroep: 01.02.05 |



|   | Afmeting in mm | Artikelnr.             |
|---|----------------|------------------------|
| <b>7045</b><br>Reparatie T-stuk 90°<br>- zonder stootrand | 20             | 7045020                |
|   | 25             | 7045025                |
|   | 32             | 7045032                |
|   | 40             | 7045040                |
|   | 50             | 7045050                |
|   | 63             | 7045063                |
|   |                | Artikelgroep: 01.02.05 |



|                                   | Afmeting in mm | Artikelnr. |
|-----------------------------------|----------------|------------|
| <b>7340</b><br>Verloop T-stuk 90° | 20 x 16 x 20   | 7340020016 |
|                                   | 25 x 20 x 25   | 7340025020 |
|                                   | 32 x 25 x 32   | 7340032025 |
|                                   | 40 x 25 x 40   | 7340040025 |
|                                   | 40 x 32 x 40   | 7340040032 |
|                                   | 50 x 25 x 50   | 7340050025 |
|                                   | 50 x 32 x 50   | 7340050032 |
|                                   | 50 x 40 x 50   | 7340050040 |
|                                   | 63 x 32 x 63   | 7340063032 |
|                                   | 63 x 40 x 63   | 7340063040 |
|                                   | 63 x 50 x 63   | 7340063050 |
|                                   | 75 x 63 x 75   | 7340075063 |
|                                   |                |            |



|   | Afmeting         | Artikelnr.             |
|---|------------------|------------------------|
| <b>7840</b><br>Overgangs<br>T-stuk 90°<br>- met buitendraad | 20 x 1/2" x 20   | 7840020012             |
|   | 20 x 3/4" x 20   | 7840020034             |
|   | 25 x 1/2" x 25   | 7840025012             |
|   | 25 x 3/4" x 25   | 7840025034             |
|   | 32 x 1" x 32     | 7840032100             |
|   | 40 x 1 1/4" x 40 | 7840040114             |
|   | 40 x 1 1/2" x 40 | 7840040112             |
|   | 50 x 1 1/4" x 50 | 7840050114             |
|   | 50 x 1 1/2" x 50 | 7840050112             |
|   | 50 x 2" x 50     | 7840050200             |
|   | 63 x 1 1/4" x 63 | 7840063114             |
|   | 63 x 1 1/2" x 63 | 7840063112             |
|   | 63 x 2" x 63     | 7840063200             |
|   |                  | Artikelgroep: 01.02.05 |



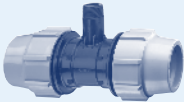
## Plasson klemfittingen



01

|  | Afmeting       | Artikelnr. |
|--|----------------|------------|
| <b>7810</b>                                | 40 x 3/4" x 40 | 7810040034 |
| <b>Overgangs</b>                           | 50 x 3/4" x 50 | 7810050034 |
| <b>T-stuk 90°</b>                          | 50 x 1" x 50   | 7810050100 |
| - met buitendraad                          | 63 x 3/4" x 63 | 7810063034 |
| - speciale kleine diameter draad-aftakking | 63 x 1" x 63   | 7810063100 |
|  | 75 x 3/4" x 75 | 7810075034 |
|  | 75 x 1" x 75   | 7810075100 |

Artikelgroep: 01.02.05



|                  | Afmeting  | Artikelnr.             |
|------------------|-----------|------------------------|
| <b>7540</b>      | 20 x 3/4" | 7540020034             |
| <b>Kruisstuk</b> |           | Artikelgroep: 01.02.05 |
| - voor sproeier  |           |                        |



|               | Afmeting          | Artikelnr. |
|---------------|-------------------|------------|
| <b>7220</b>   | 40 DN 40 (1 1/2") | 7220040112 |
| <b>E-stuk</b> | 50 DN 40 (1 1/2") | 7220050112 |
|               | 50 DN 50 (2")     | 7220050200 |
|               | 63 DN 50 (2")     | 7220063200 |
|               | 75 DN 65 (2 1/2") | 7220075212 |
|               | 90 DN 80 (3")     | 7220090300 |
|               | 90 DN100 (4")     | 7220090400 |
|               | 110 DN100 (4")    | 7220110400 |
|               | 125 DN125 (5")    | 7220125500 |
|               | 125 DN150 (6")    | 7220125600 |

|              | Afmeting       | Artikelnr.  |
|--------------|----------------|-------------|
| <b>17220</b> | 160 DN125 (5") | 17220160500 |
|              | 160 DN150 (6") | 17220160600 |

Artikelgroep: 01.02.05



|                          | Afmeting       | Artikelnr.    |
|--------------------------|----------------|---------------|
| <b>7550</b>              | 16 x 16 x 3/4" | 7550016034    |
| <b>Y-stuk</b>            | 20 x 16 x 3/4" | 7550020016034 |
| - voor druppelbevloeiing | 20 x 20 x 3/4" | 7550020034    |
|                          | 25 x 25 x 3/4" | 7550025034    |

Artikelgroep: 01.02.05



|                           | Afmeting          | Artikelnr. |
|---------------------------|-------------------|------------|
| <b>7236</b>               | 50 DN 40 (1 1/2") | 7236050112 |
| <b>Flens-aansluitstuk</b> | 50 DN 50 (2")     | 7236050200 |
|                           | 63 DN 50 (2")     | 7236063200 |
|                           | 63 DN 65 (2 1/2") | 7236063212 |
|                           | 75 DN 50 (2")     | 7236075200 |
|                           | 75 DN 65 (2 1/2") | 7236075212 |
|                           | 75 DN 80 (3")     | 7236075300 |
|                           | 90 DN 65 (2 1/2") | 7236090212 |
|                           | 90 DN 80 (3")     | 7236090300 |
|                           | 90 DN100 (4")     | 7236090400 |
|                           | 110 DN 80 (3")    | 7236110300 |
|                           | 110 DN100 (4")    | 7236110400 |
|                           | 110 DN125 (5")    | 7236110500 |

Artikelgroep: 01.02.05



|   | Afmeting    | Artikelnr. |
|---|-------------|------------|
| <b>7250</b>                                     | 25 x 1/2"   | 7250025012 |
| <b>Draadverloop</b>                             | 25 x 3/4"   | 7250025034 |
| - wartelmoer x buitendraad                      | 32 x 1/2"   | 7250032012 |
| - voor een directe aansluiting naar buitendraad | 32 x 3/4"   | 7250032034 |
|   | 32 x 1"     | 7250032100 |
|   | 40 x 1"     | 7250040100 |
|   | 40 x 1 1/4" | 7250040114 |
|   | 40 x 1 1/2" | 7250040112 |
|   | 50 x 1"     | 7250050100 |
|   | 50 x 1 1/4" | 7250050114 |
|   | 50 x 1 1/2" | 7250050112 |
|   | 50 x 2"     | 7250050200 |
|   | 63 x 1"     | 7250063100 |
|   | 63 x 1 1/4" | 7250063114 |
|   | 63 x 1 1/2" | 7250063112 |
|   | 63 x 2"     | 7250063200 |
|   | 63 x 2 1/2" | 7250063212 |
|   | 75 x 1 1/2" | 7250075112 |
|   | 75 x 2"     | 7250075200 |
|   | 75 x 2 1/2" | 7250075212 |
|   | 75 x 3"     | 7250075300 |

Artikelgroep: 01.02.05






# 01.02 Fittingen voor PE drukleidingen

## Plasson klemfittingen




01


|  | Afmeting            | Artikelnr.           |
|--|---------------------|----------------------|
| <b>7320</b><br>Victaulic<br>overgangskoppeling | 50 x 2" DN 50 (2")  | 7320050200           |
|  | 63 x 2" DN 50 (2")  | 7320063200           |
|  | 90 x 4" DN100 (4")  | 7320090400           |
|  | 110 x 4" DN100 (4") | 7320110400           |
|  |                     | Artikelgr.: 01.02.05 |




|  | Afmeting in mm | Artikelnr.             |
|--|----------------|------------------------|
| <b>7896</b><br>Rubber inzetverloop<br>- PE x koper | 20 x 15        | 7896020                |
|  | 25 x 22        | 7896025                |
|  | 32 x 28        | 7896032                |
|  | 40 x 35        | 7896040                |
|  | 50 x 42        | 7896050                |
|  |                | Artikelgroep: 01.02.05 |



|  | Afmeting in mm | Artikelnr.             |
|--|----------------|------------------------|
| <b>7930</b><br>Verloopset<br>- verloop is gemaakt van rubber | 25 x 20        | 7930025020             |
|  | 32 x 20        | 7930032020             |
|  | 32 x 25        | 7930032025             |
|  | 40 x 20        | 7930040020             |
|  | 40 x 25        | 7930040025             |
|  | 40 x 32        | 7930040032             |
|  | 50 x 25        | 7930050025             |
|  | 50 x 32        | 7930050032             |
|  | 50 x 40        | 7930050040             |
|  | 63 x 25        | 7930063025             |
|  | 63 x 32        | 7930063032             |
|  | 63 x 40        | 7930063040             |
|  | 63 x 50        | 7930063050             |
|  | 75 x 63        | 7930075063             |
|  | 110 x 63       | 7930110063             |
| 110 x 75   | 7930110075     |                        |
| 110 x 90   | 7930110090     |                        |
|  |                | Artikelgroep: 01.02.05 |



|  | Afmeting in mm | Artikelnr.             |
|--|----------------|------------------------|
| <b>7438</b><br>Trekvaste<br>verloopset<br>- PE x koper | 20 x 15        | 7438020015             |
|  | 25 x 15        | 7438025015             |
|  | 25 x 22        | 7438025022             |
|  | 32 x 28        | 7438032028             |
|  | 40 x 35        | 7438040035             |
|  | 50 x 42        | 7438050042             |
|  | 63 x 54        | 7438063054             |
|  |                | Artikelgroep: 01.02.05 |



|   | Afmeting in mm | Artikelnr.             |
|---|----------------|------------------------|
| <b>7129</b><br>Eindplug<br>- voor het afsluiten van een Plasson fitting | 20             | 7129020                |
|   | 25             | 7129025                |
|   | 32             | 7129032                |
|   | 40             | 7129040                |
|   | 50             | 7129050                |
|   | 63             | 7129063                |
|   |                | Artikelgroep: 01.02.05 |



|  | Afmeting in mm | d in mm  | H in mm | Artikelnr.             |
|--|----------------|----------|---------|------------------------|
| <b>7950</b><br>Steunbus<br>- voor PE 100 buis SDR11<br>- geschikt voor Plasson klemfittingen | 20             | 20 x 1,9 | 63      | 7950020                |
|  | 25             | 25 x 2,3 | 63      | 7950025                |
|  | 32             | 32 x 3,0 | 79      | 7950032                |
|  | 40             | 40 x 3,7 | 97      | 7950040                |
|  | 50             | 50 x 4,6 | 106     | 7950050                |
|  | 63             | 63 x 5,8 | 125     | 7950063                |
|  |                |          |         | Artikelgroep: 01.02.05 |




|   | Afmeting    | Artikelnr.             |
|---|-------------|------------------------|
| <b>7897</b><br>Overgangskoppeling<br>- PE x staalverzinkte buis | 40 x 1"     | 7897100                |
|   | 50 x 1 1/4" | 7897114                |
|   | 50 x 1 1/2" | 7897112                |
|   | 63 x 2"     | 7897200                |
|   |             | Artikelgroep: 01.02.05 |



|   | Afmeting in mm | Artikelnr.             |
|---|----------------|------------------------|
| <b>77010</b><br>Universele fitting<br>- PE x koper/lood/ gegalvaniseerd/ kunststof buis | 25 x 15-22     | 77010251522            |
|   | 25 x 20-27     | 77010252027            |
|   | 25 x 27-35     | 77010252735            |
|   | 32 x 20-27     | 77010322027            |
|   | 32 x 27-35     | 77010322735            |
|   | 50 x 35-50     | 77010503550            |
|   |                | Artikelgroep: 01.02.05 |




|   | Afmeting in mm | Artikelnr.             |
|---|----------------|------------------------|
| <b>7940</b><br>Koppelstuk<br>- voor het maken van korte verbindingen<br>- voor het maken van verdeelstukken door middel van T-stukken | 20 x 20        | 7940020                |
|   | 25 x 25        | 7940025                |
|   | 32 x 32        | 7940032                |
|   | 40 x 40        | 7940040                |
|   | 50 x 50        | 7940050                |
| 63 x 63   | 7940063        |                        |
|   |                | Artikelgroep: 01.02.05 |




|                     | Afmeting in mm | Artikelnr.             |
|---------------------|----------------|------------------------|
| <b>7970</b>         | 20             | 7970020                |
| <b>RVS grijping</b> | 25             | 7970025                |
| - toepasbaar voor   | 32             | 7970032                |
| PVC/PP leidingen    | 40             | 7970040                |
|                     | 50             | 7970050                |
|                     | 63             | 7970063                |
|                     |                | Artikelgroep: 01.02.10 |



|                        | Afmeting in mm | Artikelnr.             |
|------------------------|----------------|------------------------|
| <b>97910</b>           | 40             | 97910040               |
| <b>EPDM</b>            | 50             | 97910050               |
| <b>Afdichtingsring</b> | 63             | 97910063               |
| - met blauw kenmerk    |                | Artikelgroep: 01.02.10 |




|                   | Afmeting in mm | Artikelnr.             |
|-------------------|----------------|------------------------|
| <b>7002</b>       | 16             | 7002016                |
| <b>NBR O-ring</b> | 20             | 7002020                |
|                   | 25             | 7002025                |
|                   | 32             | 7002032                |
|                   | 125            | 7002125                |
|                   | 160            | 7002160                |
|                   |                | Artikelgroep: 01.02.10 |




|                        | Afmeting in mm | Artikelnr.             |
|------------------------|----------------|------------------------|
| <b>87910</b>           | 75             | 87910075               |
| <b>EPDM</b>            | 90             | 87910090               |
| <b>Afdichtingsring</b> | 110            | 87910110               |
| - met blauw kenmerk    |                | Artikelgroep: 01.02.10 |




|                            | Afmeting in mm | Artikelnr.             |
|----------------------------|----------------|------------------------|
| <b>97002</b>               | 40             | 97002040               |
| <b>NBR Afdichtingsring</b> | 50             | 97002050               |
|                            | 63             | 97002063               |
|                            |                | Artikelgroep: 01.02.10 |




|                           | Afmeting in mm | Artikelnr.             |
|---------------------------|----------------|------------------------|
| <b>7920</b>               | 16             | 7920016                |
| <b>Viton (FPM) O-ring</b> | 20             | 7920020                |
| - met wit kenmerk         | 25             | 7920025                |
|                           | 32             | 7920032                |
|                           |                | Artikelgroep: 01.02.10 |



|                            | Afmeting in mm | Artikelnr.             |
|----------------------------|----------------|------------------------|
| <b>87002</b>               | 75             | 87002075               |
| <b>NBR Afdichtingsring</b> | 90             | 87002090               |
|                            | 110            | 87002110               |
|                            |                | Artikelgroep: 01.02.10 |



|                        | Afmeting in mm | Artikelnr.             |
|------------------------|----------------|------------------------|
| <b>97920</b>           | 40             | 97920040               |
| <b>Viton (FPM)</b>     | 50             | 97920050               |
| <b>Afdichtingsring</b> | 63             | 97920063               |
| - met wit kenmerk      |                | Artikelgroep: 01.02.10 |



|                     | Afmeting in mm | Artikelnr.             |
|---------------------|----------------|------------------------|
| <b>7910</b>         | 16             | 7910016                |
| <b>EPDM O-ring</b>  | 20             | 7910020                |
| - met blauw kenmerk | 25             | 7910025                |
|                     | 32             | 7910032                |
|                     |                | Artikelgroep: 01.02.10 |



|                        | Afmeting in mm | Artikelnr.             |
|------------------------|----------------|------------------------|
| <b>87920</b>           | 75             | 87920075               |
| <b>Viton (FPM)</b>     | 90             | 87920090               |
| <b>Afdichtingsring</b> | 110            | 87920110               |
| - met wit kenmerk      |                | Artikelgroep: 01.02.10 |





# 01.02 Fittingen voor PE drukleidingen

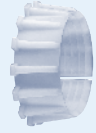
## Plasson klemfittingen onderdelen





01


|  | Afmeting in mm | Artikelnr. |
|--|----------------|------------|
| <b>7000</b><br>Wartelmoer<br> | 16             | 7000016    |
|  | 20             | 7000020    |
|  | 25             | 7000025    |
|  | 32             | 7000032    |
|  | 40             | 7000040    |
|  | 50             | 7000050    |
|  | 63             | 7000063    |
| Artikelgroep: 01.02.10   |                |            |


|   | Afmeting in mm | Artikelnr. |
|---|----------------|------------|
| <b>87004</b><br>Wartelmoer<br> | 75             | 87004075   |
|   | 90             | 87004090   |
|   | 110            | 87004110   |
| Artikelgroep: 01.02.10  |                |            |


|  | Afmeting in mm | Artikelnr. |
|--|----------------|------------|
| <b>7003</b><br>Splitring<br> | 16             | 7003016    |
|  | 20             | 7003020    |
|  | 25             | 7003025    |
|  | 32             | 7003032    |
|  | 40             | 7003040    |
|  | 50             | 7003050    |
|  | 63             | 7003063    |
| Artikelgroep: 01.02.10   |                |            |


|  | Afmeting in mm | Artikelnr. |
|--|----------------|------------|
| <b>87003</b><br>Splitring<br> | 75             | 87003075   |
|  | 90             | 87003090   |
|  | 110            | 87003110   |
| Artikelgroep: 01.02.10   |                |            |

|   | Afmeting in mm | Artikelnr. |
|---|----------------|------------|
| <b>7005</b><br>Inzetstuk<br> | 16             | 7005016    |
|   | 75             | 7005075    |
|   | 90             | 7005090    |
|   | 110            | 7005110    |
| Artikelgroep: 01.02.10  |                |            |


|  | Afmeting in mm | Artikelnr. |
|--|----------------|------------|
| <b>87005</b><br>Inzetstuk<br> | 75             | 87005075   |
|  | 90             | 87005090   |
|  | 110            | 87005110   |
| Artikelgroep: 01.02.10   |                |            |

|  | Afmeting in mm | Artikelnr. |
|--|----------------|------------|
| <b>7008</b><br>Splitring<br>- C-PVC<br> | 16             | 7008016    |
|  | 20             | 7008020    |
|  | 25             | 7008025    |
|  | 32             | 7008032    |
|  | 40             | 7008040    |
|  | 50             | 7008050    |
|  | 63             | 7008063    |
| Artikelgroep: 01.02.10   |                |            |


|   | Afmeting in mm | Artikelnr. |
|---|----------------|------------|
| <b>87008</b><br>Splitring<br>- C-PVC<br> | 75             | 87008075   |
|   | 90             | 87008090   |
|   | 110            | 87008110   |
| Artikelgroep: 01.02.10  |                |            |

|  | Afmeting             | Artikelnr. |
|--|----------------------|------------|
| <b>7006</b><br>Metalen flens<br> | 50 DN 40 (1 1/2")    | 7006040050 |
|  | 50 DN 50 (2")        | 7006050050 |
|  | 63/75 DN 50 (2")     | 7006050063 |
|  | 63 DN 65 (2 1/2")    | 7006065063 |
|  | 75/90 DN 65 (2 1/2") | 7006065075 |
|  | 75 DN 80 (3")        | 7006080075 |
|  | 90/110 DN 80 (3")    | 7006080090 |
|  | 90 DN100 (4")        | 7006100090 |
|  | 110 DN100 (4")       | 7006100110 |
|  | 110 DN125 (5")       | 7006125110 |
|  | Artikelgr.: 01.02.10 |            |

## Plasson gereedschappen

|   | Afmeting in mm | Artikelnr. |
|---|----------------|------------|
| <b>7990</b><br>Montagesleutel<br> | 16 t/m 40      | 7990016040 |
|   | 40 t/m 75      | 7990040075 |
|   | 63 t/m 125     | 7990063125 |
| Artikelgroep: 21.03.05  |                |            |

|  | Afmeting in mm | Artikelnr. |
|--|----------------|------------|
| <b>7960</b><br>Afschuinapparaat<br> | 20 t/m 63      | 7960020063 |
| Artikelgroep: 21.03.05   |                |            |

|   | Artikelnr. |
|---|------------|
| <b>79601</b><br>Reservemes voor afschuinapparaat<br> | 79601      |
| Artikelgroep: 21.03.05  |            |

## Plasson PP draadfittingen



01

|  | Afmeting | Artikelnr.             |
|--|----------|------------------------|
| <b>5017</b><br>PP Verbindings sok<br>- 2 x binnendraad | 1/2"     | 5017012012             |
|  | 3/4"     | 5017034034             |
|  | 1"       | 5017100100             |
|  | 1 1/4"   | 5017114114             |
|  | 1 1/2"   | 5017112112             |
|  | 2"       | 5017200200             |
|  |          | Artikelgroep: 01.02.15 |



|   | Afmeting | Artikelnr.             |
|---|----------|------------------------|
| <b>5067</b><br>PP Dubbele nippel<br>- 2 x buitendraad | 1/2"     | 5067012                |
|   | 3/4"     | 5067034                |
|   | 1"       | 5067100                |
|   | 1 1/4"   | 5067114                |
|   | 1 1/2"   | 5067112                |
|   | 2"       | 5067200                |
|   |          | Artikelgroep: 01.02.15 |



|  | Afmeting        | Artikelnr. |
|--|-----------------|------------|
| <b>5065</b><br>PP Verloopnippel<br>- 2 x buitendraad | 3/4" x 1/2"     | 5065034012 |
|  | 1" x 1/2"       | 5065100012 |
|  | 1" x 3/4"       | 5065100034 |
|  | 1 1/4" x 1/2"   | 5065114012 |
|  | 1 1/4" x 3/4"   | 5065114034 |
|  | 1 1/4" x 1"     | 5065114100 |
|  | 1 1/2" x 1/2"   | 5065112012 |
|  | 1 1/2" x 3/4"   | 5065112034 |
|  | 1 1/2" x 1"     | 5065112100 |
|  | 1 1/2" x 1 1/4" | 5065112114 |
|  | 2" x 1/2"       | 5065200012 |
|  | 2" x 3/4"       | 5065200034 |
|  | 2" x 1"         | 5065200100 |
|  | 2" x 1 1/4"     | 5065200114 |
|  | 2" x 1 1/2"     | 5065200112 |
|  |                 |            |



|   | Afmeting    | Artikelnr.             |
|---|-------------|------------------------|
| <b>5117</b><br>PP Verloopsok<br>- 2 x binnendraad | 3/4" x 1/2" | 5117034012             |
|   |             | Artikelgroep: 01.02.15 |



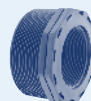
|  | Afmeting | Artikelnr.             |
|--|----------|------------------------|
| <b>5177</b><br>PP Afsluitplug<br>- met buitendraad | 3/4"     | 5177038                |
|  | 1/2"     | 5177012                |
|  | 3/4"     | 5177034                |
|  | 1"       | 5177100                |
|  | 1 1/4"   | 5177114                |
|  | 1 1/2"   | 5177112                |
|  | 2"       | 5177200                |
|  |          | Artikelgroep: 01.02.15 |



|   | Afmeting | Artikelnr.             |
|---|----------|------------------------|
| <b>5077</b><br>PP Afsluitkap<br>- met binnendraad | 1/2"     | 5077012                |
|   | 3/4"     | 5077034                |
|   | 1"       | 5077100                |
|   | 1 1/4"   | 5077114                |
|   | 1 1/2"   | 5077112                |
|   | 2"       | 5077200                |
|   |          | Artikelgroep: 01.02.15 |



|  | Afmeting        | Artikelnr.             |
|--|-----------------|------------------------|
| <b>5027</b><br>PP Verloopring<br>- buitendraad x binnendraad | 3/4" x 1/2"     | 5027034012             |
|  | 1" x 1/2"       | 5027100012             |
|  | 1" x 3/4"       | 5027100034             |
|  | 1 1/4" x 1/2"   | 5027114012             |
|  | 1 1/4" x 3/4"   | 5027114034             |
|  | 1 1/4" x 1"     | 5027114100             |
|  | 1 1/2" x 1/2"   | 5027112012             |
|  | 1 1/2" x 3/4"   | 5027112034             |
|  | 1 1/2" x 1"     | 5027112100             |
|  | 1 1/2" x 1 1/4" | 5027112114             |
|  | 2" x 1/2"       | 5027200012             |
|  | 2" x 3/4"       | 5027200034             |
|  | 2" x 1"         | 5027200100             |
|  | 2" x 1 1/4"     | 5027200114             |
|  | 2" x 1 1/2"     | 5027200112             |
|  | 2 1/2" x 2"     | 5027212200             |
|  | 3" x 1"         | 5027300100             |
|  | 3" x 1 1/4"     | 5027300114             |
|  | 3" x 1 1/2"     | 5027300112             |
|  | 3" x 2"         | 5027300200             |
| 3" x 2 1/2"  | 5027300212      |                        |
| 4" x 2"  | 5027400200      |                        |
| 4" x 3"  | 5027400300      |                        |
|  |                 | Artikelgroep: 01.02.15 |



|   | Afmeting | Artikelnr.             |
|---|----------|------------------------|
| <b>5057</b><br>PP Knie 90°<br>- 2 x binnendraad | 1/2"     | 5057012012             |
|   | 3/4"     | 5057034034             |
|   | 1"       | 5057100100             |
|   | 1 1/4"   | 5057114114             |
|   | 1 1/2"   | 5057112112             |
|   | 2"       | 5057200200             |
|   |          | Artikelgroep: 01.02.15 |



|   | Afmeting | Artikelnr.             |
|---|----------|------------------------|
| <b>5157</b><br>PP Knie 90°<br>- binnendraad x buitendraad | 1/2"     | 5157012                |
|   | 3/4"     | 5157034                |
|   | 1"       | 5157100                |
|   |          | Artikelgroep: 01.02.15 |



|   | Afmeting | Artikelnr.             |
|---|----------|------------------------|
| <b>5047</b><br>PP T-stuk 90°<br>- 3 x binnendraad | 1/2"     | 5047012                |
|   | 3/4"     | 5047034                |
|   | 1"       | 5047100                |
|   | 1 1/4"   | 5047114                |
|   | 1 1/2"   | 5047112                |
|   | 2"       | 5047200                |
|   |          | Artikelgroep: 01.02.15 |



|   | Afmeting        | Lengte | Artikelnr.           |
|---|-----------------|--------|----------------------|
| <b>5167</b><br>PP Pijpnippel<br>- 2 x buiten- draad | 1/2" x 1/2"     | 150    | 5167012012           |
|   | 3/4" x 1/2"     | 112,5  | 5167034012           |
|   | 3/4" x 3/4"     | 150    | 5167034034           |
|   | 1" x 1"         | 150    | 5167100100           |
|   | 1 1/4" x 1 1/4" | 150    | 5167114114           |
|   | 1 1/2" x 1 1/4" | 150    | 5167112114           |
|   | 1 1/2" x 1 1/2" | 150    | 5167112112           |
|   |                 |        | Artikelgr.: 01.02.15 |



# 01.02 Fittingen voor PE drukleidingen

## PP Aanboorzadels



01

|                        | Afmeting in mm | Artikelnr. |
|------------------------|----------------|------------|
| <b>6540</b>            | 63 x 25        | 6540063025 |
| <b>PP Aanboorzadel</b> | 63 x 32        | 6540063032 |
| - voor PE en PVC       | 75 x 25        | 6540075025 |
| buis                   | 75 x 32        | 6540075032 |
| - inclusief boor       | 90 x 25        | 6540090025 |
| - aanboren onder       | 90 x 32        | 6540090032 |
| druk mogelijk          | 110 x 25       | 6540110025 |
|                        | 110 x 32       | 6540110032 |
|                        | 125 x 25       | 6540125025 |
|                        | 125 x 32       | 6540125032 |
|                        | 140 x 25       | 6540140025 |
|                        | 140 x 32       | 6540140032 |
|                        | 160 x 25       | 6540160025 |
|                        | 160 x 32       | 6540160032 |

Artikelmateriaal: 01.02.20



|                                       | Afmeting/bereik in mm | Artikelnr.                 |
|---------------------------------------|-----------------------|----------------------------|
| <b>7991</b>                           | 63 t/m 160            | 7991                       |
| <b>Plasson montage-sleutel tapper</b> |                       | Artikelmateriaal: 21.03.05 |
| - voor Plasson                        |                       |                            |
| aanboorzadel 6540                     |                       |                            |
| met tapper                            |                       |                            |



|                                    | Afmeting     | Artikelnr.   |
|------------------------------------|--------------|--------------|
| <b>6076</b>                        | 32 x 1/2"    | 6076032012   |
| <b>PP Aanboorzadel</b>             | 32 x 3/4"    | 6076032034   |
| - met steunring                    | 32 x 1"      | 6076032100   |
| - inclusief O-ring                 | 40 x 1/2"    | 6076040012   |
| - inclusief gegalvaniseerde bouten | 40 x 3/4"    | 6076040034   |
|                                    | 40 x 1"      | 6076040100   |
|                                    | 50 x 1/2"    | 6076050012   |
|                                    | 50 x 3/4"    | 6076050034   |
|                                    | 50 x 1"      | 6076050100   |
|                                    | 50 x 1 1/4"  | 6076050114   |
|                                    | 63 x 1/2"    | 6076063012   |
|                                    | 63 x 3/4"    | 6076063034   |
|                                    | 63 x 1"      | 6076063100   |
|                                    | 63 x 1 1/4"  | 6076063114   |
|                                    | 63 x 1 1/2"  | 6076063112   |
|                                    | 75 x 1/2"    | 6076075012   |
|                                    | 75 x 3/4"    | 6076075034   |
|                                    | 75 x 1"      | 6076075100   |
|                                    | 75 x 1 1/4"  | 6076075114   |
|                                    | 75 x 1 1/2"  | 6076075112   |
|                                    | 75 x 2"      | 6076075200   |
|                                    | 90 x 1/2"    | 6076090012   |
|                                    | 90 x 3/4"    | 6076090034   |
|                                    | 90 x 1"      | 6076090100   |
|                                    | 90 x 1 1/4"  | 6076090114   |
|                                    | 90 x 1 1/2"  | 6076090112   |
|                                    | 90 x 2"      | 6076090200   |
|                                    | 110 x 1/2"   | 6076110012   |
|                                    | 110 x 3/4"   | 6076110034   |
|                                    | 110 x 1"     | 6076110100   |
|                                    | 110 x 1 1/4" | 6076110114   |
|                                    | 110 x 1 1/2" | 6076110112   |
|                                    | 110 x 2"     | 6076110200   |
|                                    | 110 x 3" *   | 6076110300   |
|                                    | 125 x 3/4"   | 6076125034   |
|                                    | 125 x 1"     | 6076125100   |
|                                    | 125 x 1 1/4" | 6076125114   |
|                                    | 125 x 1 1/2" | 6076125112   |
|                                    | 125 x 2"     | 6076125200   |
|                                    | 125 x 3" *   | 6076125300   |
|                                    | 125 x 4" *   | 6076125400 ↗ |



|                     | Afmeting        | Artikelnr. |
|---------------------|-----------------|------------|
| <b>Vervolg 6076</b> | 140 x 1"        | 6076140100 |
|                     | 140 x 1 1/4"    | 6076140114 |
|                     | 140 x 1 1/2"    | 6076140112 |
|                     | 140 x 2"        | 6076140200 |
|                     | 140 x 3" *      | 6076140300 |
|                     | 140 x 4" *      | 6076140400 |
|                     | 160 x 1"        | 6076160100 |
|                     | 160 x 1 1/4"    | 6076160114 |
|                     | 160 x 1 1/2"    | 6076160112 |
|                     | 160 x 2"        | 6076160200 |
|                     | 160 x 3" *      | 6076160300 |
|                     | 160 x 4" *      | 6076160400 |
|                     | 180 x 1"        | 6076180100 |
|                     | 180 x 1 1/4"    | 6076180114 |
|                     | 180 x 1 1/2"    | 6076180112 |
|                     | 180 x 2"        | 6076180200 |
|                     | 200 x 1 1/4" *  | 6076200114 |
|                     | 200 x 1 1/2" *  | 6076200112 |
|                     | 200 x 2" *      | 6076200200 |
|                     | 200 x 3" *      | 6076200300 |
|                     | 200 x 4" *      | 6076200400 |
|                     | 225 x 1 1/4" ** | 6076225114 |
|                     | 225 x 1 1/2" ** | 6076225112 |
|                     | 225 x 2" **     | 6076225200 |
|                     | 225 x 3" **     | 6076225300 |
|                     | 225 x 4" **     | 6076225400 |
|                     | 250 x 1 1/4" ** | 6076250114 |
|                     | 250 x 1 1/2" ** | 6076250112 |
|                     | 250 x 2" **     | 6076250200 |
|                     | 250 x 3" **     | 6076250300 |
|                     | 250 x 4" **     | 6076250400 |
|                     | 315 x 1 1/4" ** | 6076315114 |
|                     | 315 x 1 1/2" ** | 6076315112 |
|                     | 315 x 2" **     | 6076315200 |
|                     | 315 x 3" **     | 6076315300 |
|                     | 315 x 4" **     | 6076315400 |

Artikelmateriaal: 01.02.20

\* Maximale druk = 6 bar water  
 \*\* Maximale druk = 4 bar water

## Plasson Serie 1



- Insteekfittingen om PE buis te verbinden met PE, PVC, koper, PB (polybutyleen) en Pex.
- Steek de fitting tot aan de stootrand, voorbij de afdichting en u heeft direct een waterdichte- en trekvaste verbinding, drukklasse PN16.
- Compacte fitting met KIWA-keur (waar van toepassing).

01

|                                  | Afmeting in mm | Artikelnr.             |
|----------------------------------|----------------|------------------------|
| <b>10010</b><br>Rechte koppeling | 20             | 10010020               |
|                                  | 25             | 10010025               |
|                                  | 32             | 10010032               |
|                                  | 40             | 10010040               |
|                                  | 50             | 10010050               |
|                                  | 63             | 10010063               |
|                                  |                | Artikelgroep: 01.02.21 |



|                                  | Afmeting in mm | Artikelnr.  |
|----------------------------------|----------------|-------------|
| <b>10110</b><br>Verloopkoppeling | 25 x 20        | 10110025020 |
|                                  | 32 x 20        | 10110032020 |
|                                  | 32 x 25        | 10110032025 |
|                                  | 40 x 32        | 10110040032 |
|                                  | 50 x 25        | 10110050025 |
|                                  | 50 x 32        | 10110050032 |
|                                  | 50 x 40        | 10110050040 |
|                                  | 63 x 32        | 10110063032 |
|                                  | 63 x 40        | 10110063040 |
|                                  | 63 x 50        | 10110063050 |
|                                  |                |             |



|                               | Afmeting in mm | Artikelnr.             |
|-------------------------------|----------------|------------------------|
| <b>10120</b><br>Eindkoppeling | 20             | 10120020               |
|                               | 25             | 10120025               |
|                               | 32             | 10120032               |
|                               | 40             | 10120040               |
|                               | 50             | 10120050               |
|                               | 63             | 10120063               |
|                               |                | Artikelgroep: 01.02.21 |



|   | Afmeting    | Artikelnr.             |
|---|-------------|------------------------|
| <b>10030</b><br>Overgangskoppeling<br>- met binnendraad | 20 x 1/2"   | 10030020012            |
|   | 20 x 3/4"   | 10030020034            |
|   | 25 x 1/2"   | 10030025012            |
|   | 25 x 3/4"   | 10030025034            |
|   | 25 x 1"     | 10030025100            |
|   | 32 x 3/4"   | 10030032034            |
|   | 32 x 1"     | 10030032100            |
|   | 32 x 1 1/4" | 10030032114            |
|   | 40 x 1"     | 10030040100            |
|   | 40 x 1 1/4" | 10030040114            |
|   | 40 x 1 1/2" | 10030040112            |
|   | 50 x 1 1/4" | 10030050114            |
|   | 50 x 1 1/2" | 10030050112            |
|   | 50 x 2"     | 10030050200            |
|   | 63 x 1 1/2" | 10030063112            |
| 63 x 2"   | 10030063200 |                        |
|   |             | Artikelgroep: 01.02.21 |



|  | Afmeting    | Artikelnr.             |
|--|-------------|------------------------|
| <b>1003G</b><br>Overgangskoppeling<br>- met rechte binnendraad<br>- met vlakke afdichting<br>- inclusief NBR pakking | 25 x 3/4"   | 1003G0025034           |
|  | 25 x 1"     | 1003G0025100           |
|  | 32 x 3/4"   | 1003G0032034           |
|  | 32 x 1"     | 1003G0032100           |
|  | 40 x 1 1/2" | 1003G0040112           |
|  |             | Artikelgroep: 01.02.21 |



|   | Afmeting    | Artikelnr.             |
|---|-------------|------------------------|
| <b>10020</b><br>Overgangskoppeling<br>- met buitendraad | 20 x 1/2"   | 10020020012            |
|   | 20 x 3/4"   | 10020020034            |
|   | 25 x 1/2"   | 10020025012            |
|   | 25 x 3/4"   | 10020025034            |
|   | 25 x 1"     | 10020025100            |
|   | 32 x 3/4"   | 10020032034            |
|   | 32 x 1"     | 10020032100            |
|   | 32 x 1 1/4" | 10020032114            |
|   | 32 x 1 1/2" | 10020032112            |
|   | 32 x 2"     | 10020032200            |
|   | 40 x 1"     | 10020040100            |
|   | 40 x 1 1/4" | 10020040114            |
|   | 40 x 1 1/2" | 10020040112            |
|   | 50 x 1"     | 10020050100            |
|   | 50 x 1 1/4" | 10020050114            |
|   | 50 x 1 1/2" | 10020050112            |
|   | 63 x 1 1/2" | 10020063112            |
|   | 63 x 2"     | 10020063200            |
|   |             | Artikelgroep: 01.02.21 |



|  | Afmeting    | Artikelnr.             |
|--|-------------|------------------------|
| <b>10730</b><br>Overgangskoppeling<br>- met messing<br>binnendraad | 20 x 1/2"   | 10730020012            |
|  | 20 x 3/4"   | 10730020034            |
|  | 25 x 1/2"   | 10730025012            |
|  | 25 x 3/4"   | 10730025034            |
|  | 25 x 1"     | 10730025100            |
|  | 32 x 3/4"   | 10730032034            |
|  | 32 x 1"     | 10730032100            |
|  | 32 x 1 1/4" | 10730032114            |
|  | 40 x 3/4"   | 10730040034            |
|  | 40 x 1"     | 10730040100            |
|  | 40 x 1 1/4" | 10730040114            |
|  | 40 x 1 1/2" | 10730040112            |
|  | 50 x 1"     | 10730050100            |
|  | 50 x 1 1/4" | 10730050114            |
|  | 50 x 1 1/2" | 10730050112            |
|  | 50 x 2"     | 10730050200            |
|  | 63 x 1 1/2" | 10730063112            |
|  | 63 x 2"     | 10730063200            |
|  |             | Artikelgroep: 01.02.21 |



|   | Afmeting    | Artikelnr.             |
|---|-------------|------------------------|
| <b>1073G</b><br>Overgangskoppeling<br>- met rechte messing<br>binnendraad<br>- met vlakke afdichting<br>- inclusief NBR pakking | 25 x 3/4"   | 1073G025034            |
|   | 25 x 1"     | 1073G025100            |
|   | 32 x 3/4"   | 1073G032034            |
|   | 32 x 1"     | 1073G032100            |
|   | 40 x 1 1/4" | 1073G040114            |
|   |             | Artikelgroep: 01.02.21 |



# 01.02 Fittingen voor PE drukleidingen

## Plasson Serie 1



01

|  | Afmeting               | Artikelnr.  |
|--|------------------------|-------------|
| <b>10720</b><br>Overgangs-koppeling<br>- met messing buitendraad | 20 x 1/2"              | 10720020012 |
|  | 20 x 3/4"              | 10720020034 |
|  | 25 x 1/2"              | 10720025012 |
|  | 25 x 3/4"              | 10720025034 |
|  | 25 x 1"                | 10720025100 |
|  | 32 x 3/4"              | 10720032034 |
|  | 32 x 1"                | 10720032100 |
|  | 32 x 1 1/4"            | 10720032114 |
|  | 32 x 1 1/2"            | 10720032112 |
|  | 40 x 1"                | 10720040100 |
|  | 40 x 1 1/4"            | 10720040114 |
|  | 40 x 1 1/2"            | 10720040112 |
|  | 50 x 1"                | 10720050100 |
|  | 50 x 1 1/4"            | 10720050114 |
|  | 50 x 1 1/2"            | 10720050112 |
|  | 50 x 2"                | 10720050200 |
|  | 63 x 1 1/2"            | 10720063112 |
| 63 x 2"  | 10720063200            |             |
|  | Artikelgroep: 01.02.21 |             |



|   | Afmeting in mm         | Artikelnr.  |
|---|------------------------|-------------|
| <b>1001C</b><br>Overgangs-koppeling<br>- PE x koper | 20 x 15                | 1001C020015 |
|   | 25 x 15                | 1001C025015 |
|   | 25 x 22                | 1001C025022 |
|   | 32 x 28                | 1001C032028 |
|   | 40 x 28                | 1001C040028 |
|   | Artikelgroep: 01.02.21 |             |



|  | Afmeting               | Artikelnr.  |
|--|------------------------|-------------|
| <b>1002C</b><br>Overgangs-koppeling<br>- koper x buitendraad | 15 x 3/4"              | 1002C015034 |
|  | 22 x 3/4"              | 1002C022034 |
|  | 28 x 1"                | 1002C028100 |
|  | Artikelgroep: 01.02.21 |             |



|  | Afmeting               | Artikelnr.  |
|--|------------------------|-------------|
| <b>1003C</b><br>Overgangs-koppeling<br>- koper x binnendraad | 15 x 3/4"              | 1003C015034 |
|  | 22 x 3/4"              | 1003C022034 |
|  | Artikelgroep: 01.02.21 |             |



|  | Afmeting in mm | Artikelnr.             |
|--|----------------|------------------------|
| <b>10017</b><br>Overgangs-koppeling<br>- universeel<br>- koper, staal<br>(verzinkt), PE, PVC | 25 x 14-18     | 10017025018            |
|  | 25 x 19-22     | 10017025022            |
|  | 25 x 24-28     | 10017025028            |
|  | 25 x 31-35     | 10017025035            |
|  |                | Artikelgroep: 01.02.21 |



|   | Afmeting in mm         | Artikelnr.  |
|---|------------------------|-------------|
| <b>1001Q</b><br>Overgangs-koppeling<br>- PE x PVC | 25 x 25                | 1001Q025025 |
|   | 32 x 32                | 1001Q032032 |
|   | 40 x 40                | 1001Q040040 |
|   | Artikelgroep: 01.02.21 |             |



|  | Afmeting in mm | Artikelnr.             |
|--|----------------|------------------------|
| <b>1001QQ</b><br>Rechte koppeling<br>- voor PVC buis | 25             | 1001QQ025              |
|  | 32             | 1001QQ032              |
|  | 40             | 1001QQ040              |
|  |                | Artikelgroep: 01.02.21 |



|                          | Afmeting in mm         | Artikelnr. |
|--------------------------|------------------------|------------|
| <b>10050</b><br>Knie 90° | 20                     | 10050020   |
|                          | 25                     | 10050025   |
|                          | 32                     | 10050032   |
|                          | 40                     | 10050040   |
|                          | 50                     | 10050050   |
|                          | 63                     | 10050063   |
|                          | Artikelgroep: 01.02.21 |            |



|                                 | Afmeting in mm         | Artikelnr.  |
|---------------------------------|------------------------|-------------|
| <b>10510</b><br>Verloopknie 90° | 25 x 20                | 10510025020 |
|                                 | Artikelgroep: 01.02.21 |             |



|  | Afmeting               | Artikelnr.  |  |
|--|------------------------|-------------|--|
| <b>10150</b><br>Overgangsknie 90°<br>- met binnendraad | 20 x 1/2"              | 10150020012 |  |
|  | 20 x 3/4"              | 10150020034 |  |
|  | 20 x 1"                | 10150020100 |  |
|  | 25 x 1/2"              | 10150025012 |  |
|  | 25 x 3/4"              | 10150025034 |  |
|  | 25 x 1"                | 10150025100 |  |
|  | 32 x 3/4"              | 10150032034 |  |
|  | 32 x 1"                | 10150032100 |  |
|  | 32 x 1 1/4"            | 10150032114 |  |
|  | 40 x 1"                | 10150040100 |  |
|  | 40 x 1 1/4"            | 10150040114 |  |
|  | 40 x 1 1/2"            | 10150040112 |  |
|  | 50 x 1 1/2"            | 10150050112 |  |
|  | 50 x 2"                | 10150050200 |  |
|  | 63 x 2"                | 10150063200 |  |
|  | Artikelgroep: 01.02.21 |             |  |



|   | Afmeting    | Artikelnr.  |
|---|-------------|-------------|
| <b>10770</b><br>Overgangsknie 90°<br>- met messing<br>buitendraad | 32 x 3/4"   | 10770032034 |
|   | 32 x 1"     | 10770032100 |
|   | 32 x 1 1/4" | 10770032114 |
|   | 32 x 1 1/2" | 10770032112 |
|   | 40 x 1"     | 10770040100 |
|   | 40 x 1 1/4" | 10770040114 |
|   | 40 x 1 1/2" | 10770040112 |
|   | 50 x 1"     | 10770050100 |
|   | 50 x 1 1/4" | 10770050114 |
|   | 50 x 1 1/2" | 10770050112 |
|   | 50 x 2"     | 10770050200 |
|   | 63 x 1 1/4" | 10770063114 |
|   | 63 x 1 1/2" | 10770063112 |
|   | 63 x 2"     | 10770063200 |
| Artikelgroep: 01.02.21  |             |             |



|  | Afmeting               | Artikelnr.  |
|--|------------------------|-------------|
| <b>10850</b><br>Overgangsknie 90°<br>- met buitendraad | 20 x 1/2"              | 10850020012 |
|  | 20 x 3/4"              | 10850020034 |
|  | 25 x 1/2"              | 10850025012 |
|  | 25 x 3/4"              | 10850025034 |
|  | 25 x 1"                | 10850025100 |
|  | 32 x 3/4"              | 10850032034 |
|  | 32 x 1"                | 10850032100 |
|  | 32 x 1 1/4"            | 10850032114 |
|  | 40 x 1"                | 10850040100 |
|  | 40 x 1 1/4"            | 10850040114 |
|  | 40 x 1 1/2"            | 10850040112 |
|  | 50 x 1 1/4"            | 10850050114 |
|  | 50 x 1 1/2"            | 10850050112 |
|  | 63 x 1 1/4"            | 10850063114 |
|  | 63 x 1 1/2"            | 10850063112 |
|  | 63 x 2"                | 10850063200 |
|  | Artikelgroep: 01.02.21 |             |



|                          | Afmeting in mm | Artikelnr. |
|--------------------------|----------------|------------|
| <b>10060</b><br>Knie 45° | 32             | 10060032   |
|                          | 40             | 10060040   |
|                          | 50             | 10060050   |
|                          | 63             | 10060063   |
| Artikelgroep: 01.02.21   |                |            |



|   | Afmeting    | Artikelnr.  |
|---|-------------|-------------|
| <b>10450</b><br>Overgangsknie 45°<br>- met messing<br>buitendraad | 32 x 1"     | 10450032100 |
|   | 40 x 1 1/4" | 10450040114 |
| Artikelgroep: 01.02.21  |             |             |



|   | Afmeting               | Artikelnr.  |  |
|---|------------------------|-------------|--|
| <b>10760</b><br>Overgangsknie 90°<br>- met messing<br>binnendraad | 32 x 3/4"              | 10770032034 |  |
|   | 32 x 1"                | 10770032100 |  |
|   | 32 x 1 1/4"            | 10770032114 |  |
|   | 32 x 1 1/2"            | 10770032112 |  |
|   | 40 x 1"                | 10770040100 |  |
|   | 40 x 1 1/4"            | 10770040114 |  |
|   | 40 x 1 1/2"            | 10770040112 |  |
|   | 50 x 1"                | 10770050100 |  |
|   | 50 x 1 1/4"            | 10770050114 |  |
|   | 50 x 1 1/2"            | 10770050112 |  |
|   | 50 x 2"                | 10770050200 |  |
|   | 63 x 1 1/4"            | 10770063114 |  |
|   | 63 x 1 1/2"            | 10770063112 |  |
|   | 63 x 2"                | 10770063200 |  |
|   | Artikelgroep: 01.02.21 |             |  |



|                           | Afmeting               | Artikelnr.  |
|---------------------------|------------------------|-------------|
| <b>10750</b><br>Muurplaat | 20 x 1/2"              | 10750020012 |
|                           | 20 x 3/4"              | 10750020034 |
|                           | 25 x 1/2"              | 10750025012 |
|                           | 25 x 3/4"              | 10750025034 |
|                           | 25 x 25                | 10750025025 |
|                           | Artikelgroep: 01.02.21 |             |







# 01.02 Fittingen voor PE drukleidingen


## Plasson Serie 1





01

|   | Afmeting in mm         | Artikelnr. |
|---|------------------------|------------|
| <b>10040</b><br>T-stuk 90°<br> | 20                     | 10040020   |
|   | 25                     | 10040025   |
|   | 32                     | 10040032   |
|   | 40                     | 10040040   |
|   | 50                     | 10040050   |
|   | 63                     | 10040063   |
|   | Artikelgroep: 01.02.21 |            |

|  | Afmeting in mm         | Artikelnr. |
|--|------------------------|------------|
| <b>34100</b><br>Stopkraan<br> | 20 x 20                | 34100020   |
|  | 25 x 25                | 34100025   |
|  | 25 x 20                | 3410025020 |
|  | 32 x 32                | 34100032   |
|  | Artikelgroep: 01.02.21 |            |

|   | Afmeting in mm | Artikelnr.  |
|---|----------------|-------------|
| <b>10340</b><br>Verloop T-stuk 90°<br> | 25 x 20 x 25   | 10340025020 |
|   | 32 x 20 x 32   | 10340032020 |
|   | 32 x 25 x 32   | 10340032025 |
|   | 40 x 25 x 40   | 10340040025 |
|   | 40 x 32 x 40   | 10340040032 |
|   | 50 x 25 x 50   | 10340050025 |
|   | 50 x 32 x 50   | 10340050032 |
|   | 63 x 25 x 63   | 10340063025 |
|   | 63 x 32 x 63   | 10340063032 |
| Artikelgroep: 01.02.21  |                |             |

|  | Afmeting in mm         | Artikelnr.  |
|--|------------------------|-------------|
| <b>3410C</b><br>Stopkraan<br>- PE x koper<br> | 20 x 15                | 3410C020015 |
|  | 25 x 15                | 3410C025015 |
|  | 25 x 22                | 3410C025022 |
|  | 32 x 28                | 3410C032028 |
|  | Artikelgroep: 01.02.21 |             |

|   | Afmeting               | Artikelnr.  |
|---|------------------------|-------------|
| <b>10140</b><br>Overgangs<br>T-stuk 90°<br>- met binnendraad<br> | 20 x 1/2"              | 10140020012 |
|   | 20 x 3/4"              | 10140020034 |
|   | 20 x 1"                | 10140020100 |
|   | 25 x 1/2"              | 10140025012 |
|   | 25 x 3/4"              | 10140025034 |
|   | 25 x 1"                | 10140025100 |
|   | 32 x 3/4"              | 10140032034 |
|   | 32 x 1"                | 10140032100 |
|   | 32 x 1 1/4"            | 10140032114 |
|   | Artikelgroep: 01.02.21 |             |

|  | Afmeting               | Artikelnr.  |
|--|------------------------|-------------|
| <b>35891</b><br>Koppeling 2-delig<br>- voor o.a. water-<br>meta aansluiting<br>en verdeelstukken<br>- directe aansluiting<br>voor Serie 1<br>- per set à 2 stuks<br> | 3/4" (wartel) x 20     | 35891034020 |
|  | 1" (wartel) x 25       | 35891100025 |
|  | 3/4" x 1/2"            | 35890034012 |
|  | 1" x 3/4"              | 35890100034 |
|  | Artikelgroep: 01.02.21 |             |

## Plasson Serie 1 gereedschappen en toebehoren

|  | Afmeting in mm         | Artikelnr.  |
|--|------------------------|-------------|
| <b>10990</b><br>Demontagesleutel<br>- voor Plasson<br>Serie 1 fittingen<br> | 20 t/m 32              | 10990020032 |
|  | 40 t/m 63              | 10990040063 |
|  | Artikelgroep: 21.03.05 |             |

|  | Afmeting rol l x b x dikte | Artikelnr. |
|--|----------------------------|------------|
| <b>1715</b><br>PTFE (Teflon) tape<br>- met Gastec QA<br>- kleur: rood<br> | 12 meter x 12mm x 0,1mm    | 1715       |
| Artikelgroep: 19.02.05   |                            |            |

|   | Inhoud in gram         | Artikelnr. |
|---|------------------------|------------|
| <b>1729</b><br>Glijmiddel Blue Gel<br> | knijpfles 250          | 1729250    |
|   | Artikelgroep: 19.01.05 |            |

|   | Artikelnr. |
|---|------------|
| <b>17110</b><br>Markeerstift<br>- wit<br>- voor het markeren van de insteekdiepte<br>op PE buis<br> | 171100003  |
| Artikelgroep: 21.03.05  |            |

## Plasson elektrolasfittingen

- Plasson elektrolasfittingen zijn voorzien van praktisch alle internationale drinkwater normen.
- Elektrolasfittingen met KIWA-keur (waar van toepassing).
- Deze elektrolasfittingen zijn inclusief aangegoten moffen. Hier vallen de spie-aansluitingen buiten (zoals de spie-aansluitingen van de T-stukken).
- Een instructie over het gebruik van Plasson elektrolasfittingen is op te vragen bij onze verkoopmedewerkers of te downloaden via [www.milder.nl](http://www.milder.nl).

|   | Afmeting in mm | Artikelnr.             |
|---|----------------|------------------------|
| <b>9010</b><br>Mof  | 16             | 9010016                |
|   | 20             | 9010020                |
|   | 25             | 9010025                |
|   | 32             | 9010032                |
|   | 40             | 9010040                |
|   | 50             | 9010050                |
|   | 63             | 9010063                |
|   | 75             | 9010075                |
|   | 90             | 9010090                |
|   | 110            | 9010110                |
|   | 125            | 9010125                |
|   | 140            | 9010140                |
|   | 160            | 9010160                |
|   | 180            | 9010180                |
|   | 200            | 9010200                |
|   | 225            | 9010225                |
|   | 250*           | 9010250                |
|   | 280*           | 9010280                |
|   | 315*           | 9010315                |
|   | 355*           | 9010355                |
| 400*  | 9010400        |                        |
|  | 450*           | 9010450                |
|   | 500*           | 9010500                |
|   | 560*           | 9010560                |
|   | 630*           | 9010630                |
|   | 710*           | 9010710                |
|   | 800*           | 9010800                |
|   |                | Artikelgroep: 01.02.25 |

\* Voor Lightfit Mof verwijzen wij u naar artikel 6010 blz. 48.

|                         | Afmeting in mm         | Artikelnr. |
|-------------------------|------------------------|------------|
| <b>9050</b><br>Knie 90° | 20                     | 9050020    |
|                         | 25                     | 9050025    |
|                         | 32                     | 9050032    |
|                         | 40                     | 9050040    |
|                         | 50                     | 9050050    |
|                         | 63                     | 9050063    |
|                         | 75                     | 9050075    |
|                         | 90                     | 9050090    |
|                         | 110                    | 9050110    |
|                         | 125                    | 9050125    |
|                         | 140                    | 9050140    |
|                         | 160                    | 9050160    |
|                         | 180                    | 9050180    |
|                         | 200                    | 9050200    |
|                         | 225                    | 9050225    |
| 250                     | 9050250                |            |
|                         | Artikelgroep: 01.02.25 |            |

|                         | Afmeting in mm | Artikelnr.             |
|-------------------------|----------------|------------------------|
| <b>9060</b><br>Knie 45° | 32             | 9060032                |
|                         | 40             | 9060040                |
|                         | 50             | 9060050                |
|                         | 63             | 9060063                |
|                         | 75             | 9060075                |
|                         | 90             | 9060090                |
|                         | 110            | 9060110                |
|                         | 125            | 9060125                |
|                         | 140            | 9060140                |
|                         | 160            | 9060160                |
|                         | 180            | 9060180                |
|                         | 200            | 9060200                |
|                         | 225            | 9060225                |
|                         | 250            | 9060250                |
|                         |                | Artikelgroep: 01.02.25 |

|                           | Afmeting in mm         | Artikelnr. |
|---------------------------|------------------------|------------|
| <b>9110</b><br>Verloopsok | 20 x 16                | 9110020016 |
|                           | 25 x 20                | 9110025020 |
|                           | 32 x 20                | 9110032020 |
|                           | 32 x 25                | 9110032025 |
|                           | 40 x 25                | 9110040025 |
|                           | 40 x 32                | 9110040032 |
|                           | 50 x 25                | 9110050025 |
|                           | 50 x 32                | 9110050032 |
|                           | 50 x 40                | 9110050040 |
|                           | 63 x 32                | 9110063032 |
|                           | 63 x 40                | 9110063040 |
|                           | 63 x 50                | 9110063050 |
|                           | 75 x 63                | 9110075063 |
|                           | 90 x 50                | 9110090050 |
|                           | 90 x 63                | 9110090063 |
|                           | 90 x 75                | 9110090075 |
|                           | 110 x 63               | 9110110063 |
|                           | 110 x 90               | 9110110090 |
|                           | 125 x 90               | 9110125090 |
|                           | 125 x 110              | 9110125110 |
| 160 x 90                  | 9110160090             |            |
| 160 x 110                 | 9110160110             |            |
| 160 x 125                 | 9110160125             |            |
| 180 x 125                 | 9110180125             |            |
|                           | Artikelgroep: 01.02.25 |            |

|                           | Afmeting in mm         | Artikelnr. |
|---------------------------|------------------------|------------|
| <b>9080</b><br>Knie 22,5° | 90                     | 9080090    |
|                           | 110                    | 9080110    |
|                           | 125                    | 9080125    |
|                           | 160                    | 9080160    |
|                           | 180                    | 9080180    |
|                           | Artikelgroep: 01.02.25 |            |

Een elektrolasinstructie voor Plasson elektrolasfittingen is op te vragen via onze afdeling verkoop of te downloaden via [www.milder.nl](http://www.milder.nl).



# 01.02 Fittingen voor PE drukleidingen

## Plasson elektrolasfittingen



01

|                           | Afmeting in mm | Artikelnr. |
|---------------------------|----------------|------------|
| <b>9120</b>               | 20             | 9120020    |
| <b>Eindkap</b>            | 25             | 9120025    |
| - inclusief elektrolasmof | 32             | 9120032    |
|                           | 40             | 9120040    |
|                           | 50             | 9120050    |
|                           | 63             | 9120063    |
|                           | 75             | 9120075    |
|                           | 90             | 9120090    |
|                           | 110            | 9120110    |
|                           | 125            | 9120125    |
|                           | 140            | 9120140    |
|                           | 160            | 9120160    |
|                           | 180            | 9120180    |
|                           | 200            | 9120200    |
|                           | 225            | 9120225    |
|                           | 250            | 9120250    |
|                           | 280            | 9120280    |
|                           | 315            | 9120315    |

Artikelgroep: 01.02.25

Voor eindplug zonder mof zie blz. 50, artikelnr. 9127.



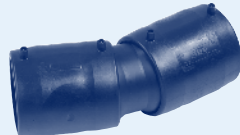
|                   | Afmeting in mm | Artikelnr. |
|-------------------|----------------|------------|
| <b>9040</b>       | 20             | 9040020020 |
| <b>T-stuk 90°</b> | 25             | 9040025025 |
|                   | 32             | 9040032032 |
|                   | 40             | 9040040040 |
|                   | 50             | 9040050050 |
|                   | 63             | 9040063063 |
|                   | 75             | 9040075075 |
|                   | 90             | 9040090090 |
|                   | 110            | 9040110110 |
|                   | 125            | 9040125125 |
|                   | 160            | 9040160160 |
|                   | 180            | 9040180180 |
|                   | 200            | 9040200200 |
|                   | 225            | 9040225225 |
|                   | 250            | 9040250250 |

Artikelgroep: 01.02.25



|   | Afmeting in mm | Artikelnr. |
|---|----------------|------------|
| <b>947C</b>   | 90             | 947C090    |
| <b>Flexibele koppeling</b>  | 110            | 947C110    |
| - 2 x mof   | 125            | 947C225    |
| - maximale bereikbare hoek is 24°   | 160            | 947C160    |
| - voor het verbinden van niet in lijn liggende leidingen                        | 180            | 947C180    |
| - voor het verbinden van leidingen waarvan de exacte hoek vooraf niet bekend is | 200            | 947C200    |
|   | 225            | 947C225    |
|   | 250            | 947C550    |

Artikelgr.: 01.02.25



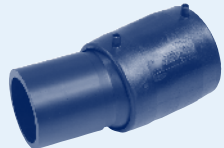
|                           | Afmeting in mm  | Artikelnr. |
|---------------------------|-----------------|------------|
| <b>9140</b>               | 25 x 20 x 25    | 9140025020 |
| <b>Verloop T-stuk 90°</b> | 25 x 32 x 25    | 9140025032 |
|                           | 32 x 20 x 32    | 9140032020 |
|                           | 32 x 25 x 32    | 9140032025 |
|                           | 40 x 20 x 40    | 9140040020 |
|                           | 40 x 25 x 40    | 9140040025 |
|                           | 40 x 32 x 40    | 9140040032 |
|                           | 50 x 20 x 50    | 9140050020 |
|                           | 50 x 25 x 50    | 9140050025 |
|                           | 50 x 32 x 50    | 9140050032 |
|                           | 50 x 40 x 50    | 9140050040 |
|                           | 63 x 20 x 63    | 9140063020 |
|                           | 63 x 32 x 63    | 9140063032 |
|                           | 63 x 40 x 63    | 9140063040 |
|                           | 63 x 50 x 63    | 9140063050 |
|                           | 75 x 63 x 75    | 9140075063 |
|                           | 90 x 63 x 90    | 9140090063 |
|                           | 110 x 63 x 110  | 9140110063 |
|                           | 110 x 90 x 110  | 9140110090 |
|                           | 125 x 90 x 125  | 9140125090 |
|                           | 125 x 110 x 125 | 9140125110 |
|                           | 160 x 90 x 160  | 9140160090 |
|                           | 160 x 110 x 160 | 9140160110 |
|                           | 160 x 125 x 160 | 9140160125 |
|                           | 180 x 90 x 180  | 9140180090 |
|                           | 180 x 110 x 180 | 9140180110 |
|                           | 180 x 125 x 180 | 9140180125 |
|                           | 180 x 140 x 180 | 9140180140 |
|                           | 180 x 160 x 180 | 9140180160 |
|                           | 200 x 90 x 200  | 9140200090 |
|                           | 200 x 110 x 200 | 9140200110 |
|                           | 225 x 90 x 225  | 9140225090 |
|                           | 225 x 110 x 225 | 9140225110 |
|                           | 250 x 90 x 250  | 9140250090 |
|                           | 250 x 110 x 250 | 9140250110 |

Artikelgroep: 01.02.25



|  | Afmeting in mm | Artikelnr. |
|--|----------------|------------|
| <b>947D</b>  | 90             | 947D090    |
| <b>Flexibele koppeling</b>   | 110            | 947D110    |
| - 1 x mof / 1 x spie   | 125            | 947D225    |
| - maximale bereikbare hoek is 12°  | 160            | 947D160    |
| - voor het verbinden van niet in lijn liggende leidingen                         | 180            | 947D180    |
| - voor het verbinden van leidingen waarvan de exacte hoek vooraf niet bekend is. | 200            | 947D200    |
|  | 225            | 947D225    |
|  | 250            | 947D250    |

Artikelgr.: 01.02.25



## Plasson elektrolasfittingen



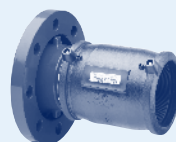
|  | Afmeting          | Artikelnr. |
|--|-------------------|------------|
| <b>9940</b><br><b>T-stuk 90°</b><br>- met flensaftakking | 90 x DN80 x 90    | 9940090080 |
|  | 110 x DN80 x 110  | 9940110080 |
|  | 110 x DN100 x 110 | 9940110100 |
|  | 125 x DN80 x 125  | 9940125080 |
|  | 125 x DN100 x 125 | 9940125100 |
|  | 160 x DN80 x 160  | 9940160080 |
|  | 160 x DN100 x 160 | 9940160100 |
|  | 180 x DN80 x 180  | 9940180080 |
|  | 180 x DN100 x 180 | 9940180100 |
|  | 200 x DN80 x 200  | 9940200080 |
|  | 200 x DN100 x 200 | 9940200100 |
|  | 225 x DN80 x 225  | 9940225080 |
|  | 225 x DN100 x 225 | 9940225100 |
|  | 250 x DN80 x 250  | 9940250080 |
| 250 x DN100 x 250  | 9940250100        |            |

Artikelgr.: 01.02.25



|   | Afmeting    | Artikelnr. |
|---|-------------|------------|
| <b>9770</b><br><b>Overgangskoppeling</b><br>- voorzien van<br>gietijzer flens | 63 x DN50   | 9770063050 |
|   | 90 x DN80   | 9770090080 |
|   | 110 x DN100 | 9770110100 |
|   | 125 x DN100 | 9770125100 |
|   | 160 x DN150 | 9770160150 |
|   | 180 x DN150 | 9770180150 |
|   | 225 x DN200 | 9770225200 |

Artikelgr.: 01.02.25



|   | Afmeting in mm    | Artikelnr. |
|---|-------------------|------------|
| <b>9240*</b><br><b>Dubbel T-stuk</b><br>- voor aardwarmte | 40 x 25 x 25 x 40 | 9240040025 |
|   | 40 x 32 x 32 x 40 | 9240040032 |
|   | 50 x 25 x 25 x 50 | 9240050025 |
|   | 50 x 32 x 32 x 50 | 9240050032 |
|   | 50 x 40 x 40 x 50 | 9240050040 |
|   | 63 x 25 x 25 x 63 | 9240063025 |
|   | 63 x 32 x 32 x 63 | 9240063032 |
|   | 63 x 40 x 40 x 63 | 9240063040 |

Artikelgroep: 01.02.25



\* Andere producten m.b.t. aardwarmte zijn op aanvraag leverbaar.

|   | Afmeting in mm | Artikelnr. |
|---|----------------|------------|
| <b>9190*</b><br><b>Y-verloopstuk</b><br>- voor aardwarmte | 32 x 25 x 25   | 9190032025 |
|   | 40 x 32 x 32   | 9190040032 |
|   | 50 x 40 x 40   | 9190050040 |

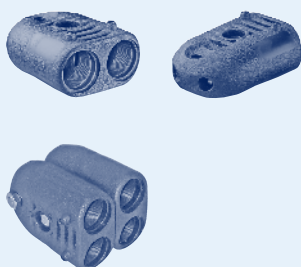
Artikelgroep: 01.02.25



\* Andere producten m.b.t. aardwarmte zijn op aanvraag leverbaar.

|  | Afmeting in mm | Artikelnr. |
|--|----------------|------------|
| <b>9090*</b><br><b>180° Knie</b><br>- voor het maken<br>van collectoren<br>voor aardwarmte | 25             | 9090025    |
|  | 32             | 9090032    |
|  | 40             | 9090040    |

Artikelgroep: 01.02.25



De 180° knie is eenvoudig met elkaar te verbinden om dubbele collectoren te maken.

\* Andere producten m.b.t. aardwarmte zijn op aanvraag leverbaar.

|   | Afmeting    | Artikelnr. |
|---|-------------|------------|
| <b>9710</b><br><b>Overgangskoppeling</b><br>- met PE buitendraad<br>- uitsluitend voor<br>water | 25 x 3/4"   | 9710025034 |
|   | 32 x 1"     | 9710032100 |
|   | 40 x 1"     | 9710040100 |
|   | 40 x 1 1/4" | 9710040114 |
|   | 40 x 1 1/2" | 9710040112 |
|   | 50 x 1 1/2" | 9710050112 |
|   | 63 x 1 1/2" | 9710063112 |
|   | 63 x 2"     | 9710063200 |

Artikelgr.: 01.02.25



# 01.02 Fittingen voor PE drukleidingen

## Plasson elektrolasfittingen



01

|                          | Afmeting    | Artikelnr.           |
|--------------------------|-------------|----------------------|
| <b>9750</b>              | 20 x 1/2"   | 9750020012           |
| <b>Overgangsknie 90°</b> | 25 x 3/4"   | 9750025034           |
| - met PE buitendraad     | 32 x 1"     | 9750032100           |
| - uitsluitend voor water | 40 x 1"     | 9750040100           |
|                          | 40 x 1 1/4" | 9750040114           |
|                          | 40 x 1 1/2" | 9750040112           |
|                          | 50 x 1 1/2" | 9750050112           |
|                          | 63 x 1 1/2" | 9750063112           |
|                          | 63 x 2"     | 9750063200           |
|                          |             | Artikelgr.: 01.02.25 |



|                           | Afmeting    | Artikelnr.           |
|---------------------------|-------------|----------------------|
| <b>9310</b>               | 20 x 1/2"   | 9310020012           |
| <b>Overgangskoppeling</b> | 25 x 3/4"   | 9310025034           |
| - met messing binnendraad | 32 x 3/4"   | 9310032034           |
|                           | 32 x 1"     | 9310032100           |
|                           | 32 x 1 1/2" | 9310032112           |
|                           | 40 x 1"     | 9310040100           |
|                           | 40 x 1 1/4" | 9310040114           |
|                           | 40 x 1 1/2" | 9310040112           |
|                           | 50 x 1 1/2" | 9310050112           |
|                           | 50 x 2"     | 9310050200           |
|                           | 63 x 1 1/2" | 9310063112           |
|                           | 63 x 2"     | 9310063200           |
|                           |             | Artikelgr.: 01.02.25 |



|                          | Afmeting    | Artikelnr.           |
|--------------------------|-------------|----------------------|
| <b>9760</b>              | 32 x 1"     | 9760032100           |
| <b>Overgangsknie 45°</b> | 40 x 1"     | 9760040100           |
| - met PE buitendraad     | 40 x 1 1/4" | 9760040114           |
| - uitsluitend voor water | 40 x 1 1/2" | 9760040112           |
|                          | 50 x 1 1/2" | 9760050112           |
|                          | 63 x 1 1/2" | 9760063112           |
|                          | 63 x 2"     | 9760063200           |
|                          |             | Artikelgr.: 01.02.25 |



|                           | Afmeting    | Artikelnr.           |
|---------------------------|-------------|----------------------|
| <b>9250</b>               | 20 x 1/2"   | 9250020012           |
| <b>Overgangsknie 90°</b>  | 25 x 3/4"   | 9250025034           |
| - met messing buitendraad | 32 x 1/4"   | 9250032012           |
|                           | 32 x 3/4"   | 9250032034           |
|                           | 32 x 1"     | 9250032100           |
|                           | 32 x 1 1/4" | 9250032114           |
|                           | 32 x 1 1/2" | 9250032112           |
|                           | 40 x 1"     | 9250040100           |
|                           | 40 x 1 1/4" | 9250040114           |
|                           | 40 x 1 1/2" | 9250040112           |
|                           | 40 x 2"     | 9250040200           |
|                           | 50 x 1"     | 9250050100           |
|                           | 50 x 1 1/4" | 9250050114           |
|                           | 50 x 1 1/2" | 9250050112           |
|                           | 50 x 2"     | 9250050200           |
|                           | 63 x 1 1/4" | 9250063114           |
|                           | 63 x 1 1/2" | 9250063112           |
|                           | 63 x 2"     | 9250063200           |
|                           | 75 x 2"     | 9250075200           |
|                           | 75 x 2 1/2" | 9250075212           |
|                           |             | Artikelgr.: 01.02.25 |



|                           | Afmeting    | Artikelnr.           |
|---------------------------|-------------|----------------------|
| <b>9210</b>               | 20 x 1/2"   | 9210020012           |
| <b>Overgangskoppeling</b> | 25 x 3/4"   | 9210025034           |
| - met messing buitendraad | 32 x 1/2"   | 9210032012           |
|                           | 32 x 3/4"   | 9210032034           |
|                           | 32 x 1"     | 9210032100           |
|                           | 32 x 1 1/4" | 9210032114           |
|                           | 32 x 1 1/2" | 9210032112           |
|                           | 40 x 1"     | 9210040100           |
|                           | 40 x 1 1/4" | 9210040114           |
|                           | 40 x 1 1/2" | 9210040112           |
|                           | 40 x 2"     | 9210040200           |
|                           | 50 x 1"     | 9210050100           |
|                           | 50 x 1 1/4" | 9210050114           |
|                           | 50 x 1 1/2" | 9210050112           |
|                           | 50 x 2"     | 9210050200           |
|                           | 63 x 1 1/4" | 9210063114           |
|                           | 63 x 1 1/2" | 9210063112           |
|                           | 63 x 2"     | 9210063200           |
|                           | 75 x 2"     | 9210075200           |
|                           | 75 x 2 1/2" | 9210075212           |
|                           |             | Artikelgr.: 01.02.25 |



|                           | Afmeting    | Artikelnr.             |
|---------------------------|-------------|------------------------|
| <b>9350</b>               | 20 x 1/2"   | 9350020012             |
| <b>Overgangsknie 90°</b>  | 25 x 3/4"   | 9350025034             |
| - met messing binnendraad | 32 x 3/4"   | 9350032034             |
|                           | 32 x 1"     | 9350032100             |
|                           | 32 x 1 1/2" | 9350032112             |
|                           | 40 x 1"     | 9350040100             |
|                           | 40 x 1 1/4" | 9350040114             |
|                           | 40 x 1 1/2" | 9350040112             |
|                           | 50 x 1 1/2" | 9350050112             |
|                           | 50 x 2"     | 9350050200             |
|                           | 63 x 1 1/2" | 9350063112             |
|                           | 63 x 2"     | 9350063200             |
|                           |             | Artikelgroep: 01.02.25 |





Voor elektrolasmachines verwijzen wij u naar Groep 21 'Machines en gereedschappen'.



|                          | Afmeting    | Artikelnr.             |
|--------------------------|-------------|------------------------|
| <b>9360</b>              | 32 x 1"     | 9360032100             |
| <b>Overgangsknie 45°</b> | 40 x 1"     | 9360040100             |
| - met messing            | 40 x 1 1/4" | 9360040114             |
| binnendraad              | 40 x 1 1/2" | 9360040112             |
|                          | 50 x 1 1/2" | 9360050112             |
|                          | 50 x 2"     | 9360050200             |
|                          | 63 x 1 1/2" | 9360063112             |
|                          | 63 x 2"     | 9360063200             |
|                          |             | Artikelgroep: 01.02.25 |



|                          | Afmeting    | Artikelnr.             |
|--------------------------|-------------|------------------------|
| <b>9450</b>              | 20 x 3/4"   | 9450020034             |
| <b>Overgangsknie 90°</b> | 25 x 3/4"   | 9450025034             |
| - met messing            | 25 x 1"     | 9450025100             |
| binnendraad              | 32 x 1"     | 9450032100             |
| - met losse wartel       | 32 x 1 1/4" | 9450032114             |
|                          | 40 x 1 1/2" | 9450040112             |
|                          | 50 x 2"     | 9450050200             |
|                          | 63 x 2"     | 9450063200             |
|                          | 63 x 2 1/2" | 9450063212             |
|                          |             | Artikelgroep: 01.02.25 |



|                          | Afmeting    | Artikelnr.             |
|--------------------------|-------------|------------------------|
| <b>9260</b>              | 32 x 1/2"   | 9260032012             |
| <b>Overgangsknie 45°</b> | 32 x 3/4"   | 9260032034             |
| - met messing            | 32 x 1"     | 9260032100             |
| buitendraad              | 32 x 1 1/4" | 9260032114             |
|                          | 32 x 1 1/2" | 9260032112             |
|                          | 40 x 1"     | 9260040100             |
|                          | 40 x 1 1/4" | 9260040114             |
|                          | 40 x 1 1/2" | 9260040112             |
|                          | 40 x 2"     | 9260040200             |
|                          | 50 x 1"     | 9260050100             |
|                          | 50 x 1 1/4" | 9260050114             |
|                          | 50 x 1 1/2" | 9260050112             |
|                          | 50 x 2"     | 9260050200             |
|                          | 63 x 1 1/4" | 9260063114             |
|                          | 63 x 1 1/2" | 9260063112             |
|                          | 63 x 2"     | 9260063200             |
|                          | 75 x 2"     | 9260075200             |
|                          | 75 x 2 1/2" | 9260075212             |
|                          |             | Artikelgroep: 01.02.25 |



|                          | Afmeting    | Artikelnr.             |
|--------------------------|-------------|------------------------|
| <b>9460</b>              | 32 x 1"     | 9460032100             |
| <b>Overgangsknie 45°</b> | 32 x 1 1/4" | 9460032114             |
| - met messing            | 40 x 1 1/2" | 9460040112             |
| binnendraad              | 50 x 2"     | 9460050200             |
| - met losse wartel       | 63 x 2"     | 9460063200             |
|                          | 63 x 2 1/2" | 9460063212             |
|                          |             | Artikelgroep: 01.02.25 |



|                           | Afmeting    | Artikelnr.             |
|---------------------------|-------------|------------------------|
| <b>9410</b>               | 20 x 3/4"   | 9410020034             |
| <b>Overgangskoppeling</b> | 25 x 3/4"   | 9410025034             |
| - met messing             | 25 x 1"     | 9410025100             |
| binnendraad               | 32 x 1"     | 9410032100             |
| - met losse wartel        | 32 x 1 1/4" | 9410032114             |
|                           | 40 x 1 1/2" | 9410040112             |
|                           | 50 x 1 1/4" | 9410050114             |
|                           | 50 x 2"     | 9410050200             |
|                           | 63 x 2"     | 9410063200             |
|                           | 63 x 2 1/2" | 9410063212             |
|                           |             | Artikelgroep: 01.02.25 |



|                          | Afmeting    | Artikelnr.             |
|--------------------------|-------------|------------------------|
| <b>9461</b>              | 32 x 1"     | 9461032100             |
| <b>Overgangsknie 45°</b> | 40 x 1 1/4" | 9461040114             |
| - met messing            | 50 x 1 1/2" | 9461050112             |
| buitendraad              | 63 x 1 1/2" | 9461063112             |
| - met losse wartel       | 63 x 2"     | 9461063200             |
|                          |             | Artikelgroep: 01.02.25 |



# 01.02 Fittingen voor PE drukleidingen

## Plasson elektrolas aanboorzadels



01

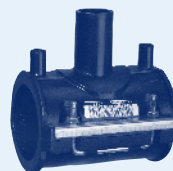
|                     | Afmeting in mm | Artikelnr. |
|---------------------|----------------|------------|
| <b>9540</b>         | 63 x 32        | 9540063032 |
| <b>Aanboorzadel</b> | 63 x 40        | 9540063040 |
| - inclusief boor    | 63 x 50        | 9540063050 |
| - aanboren onder    | 63 x 63        | 9540063063 |
| druk mogelijk       | 75 x 32        | 9540075032 |
| - met kunststof     | 75 x 40        | 9540075040 |
| afsluiter           | 75 x 50        | 9540075050 |
|                     | 75 x 63        | 9540075063 |
|                     | 90 x 32        | 9540090032 |
|                     | 90 x 40        | 9540090040 |
|                     | 90 x 50        | 9540090050 |
|                     | 90 x 63        | 9540090063 |
|                     | 110 x 32       | 9540110032 |
|                     | 110 x 40       | 9540110040 |
|                     | 110 x 50       | 9540110050 |
|                     | 110 x 63       | 9540110063 |
|                     | 125 x 32       | 9540125032 |
|                     | 125 x 40       | 9540125040 |
|                     | 125 x 50       | 9540125050 |
|                     | 125 x 63       | 9540125063 |
|                     | 140 x 32       | 9540140032 |
|                     | 140 x 40       | 9540140040 |
|                     | 140 x 50       | 9540140050 |
|                     | 140 x 63       | 9540140063 |
|                     | 160 x 32       | 9540160032 |
|                     | 160 x 40       | 9540160040 |
|                     | 160 x 50       | 9540160050 |
|                     | 160 x 63       | 9540160063 |
|                     | 180 x 32       | 9540180032 |
|                     | 180 x 40       | 9540180040 |
|                     | 180 x 50       | 9540180050 |
|                     | 180 x 63       | 9540180063 |
|                     | 200 x 32       | 9540200032 |
|                     | 200 x 40       | 9540200040 |
|                     | 200 x 50       | 9540200050 |
|                     | 200 x 63       | 9540200063 |
|                     | 225 x 32       | 9540225032 |
|                     | 225 x 40       | 9540225040 |
|                     | 225 x 50       | 9540225050 |
|                     | 225 x 63       | 9540225063 |
|                     | 250 x 32       | 9540250032 |
|                     | 250 x 40       | 9540250040 |
|                     | 250 x 50       | 9540250050 |
|                     | 250 x 63       | 9540250063 |

Artikelgroep: 01.02.30



|                     | Afmeting in mm | Artikelnr. |
|---------------------|----------------|------------|
| <b>9580</b>         | 63 x 32        | 9580063032 |
| <b>Aanboorzadel</b> | 63 x 40        | 9580063040 |
| - met spie-eind     | 63 x 50        | 9580063050 |
|                     | 63 x 63        | 9580063063 |
|                     | 75 x 32        | 9580075032 |
|                     | 75 x 40        | 9580075040 |
|                     | 75 x 50        | 9580075050 |
|                     | 75 x 63        | 9580075063 |
|                     | 90 x 32        | 9580090032 |
|                     | 90 x 40        | 9580090040 |
|                     | 90 x 50        | 9580090050 |
|                     | 90 x 63        | 9580090063 |
|                     | 90 x 90        | 9580090090 |
|                     | 110 x 32       | 9580110032 |
|                     | 110 x 40       | 9580110040 |
|                     | 110 x 50       | 9580110050 |
|                     | 110 x 63       | 9580110063 |
|                     | 110 x 90       | 9580110090 |
|                     | 125 x 32       | 9580125032 |
|                     | 125 x 40       | 9580125040 |
|                     | 125 x 50       | 9580125050 |
|                     | 125 x 63       | 9580125063 |
|                     | 125 x 90       | 9580125090 |
|                     | 140 x 32       | 9580140032 |
|                     | 140 x 40       | 9580140040 |
|                     | 140 x 50       | 9580140050 |
|                     | 140 x 63       | 9580140063 |
|                     | 140 x 90       | 9580140090 |
|                     | 160 x 32       | 9580160032 |
|                     | 160 x 40       | 9580160040 |
|                     | 160 x 50       | 9580160050 |
|                     | 160 x 63       | 9580160063 |
|                     | 160 x 90       | 9580160090 |
|                     | 180 x 32       | 9580180032 |
|                     | 180 x 40       | 9580180040 |
|                     | 180 x 50       | 9580180050 |
|                     | 180 x 63       | 9580180063 |
|                     | 200 x 32       | 9580200032 |
|                     | 200 x 40       | 9580200040 |
|                     | 200 x 50       | 9580200050 |
|                     | 200 x 63       | 9580200063 |
|                     | 225 x 32       | 9580225032 |
|                     | 225 x 40       | 9580225040 |
|                     | 225 x 50       | 9580225050 |
|                     | 225 x 63       | 9580225063 |
|                     | 250 x 32       | 9580250032 |
|                     | 250 x 40       | 9580250040 |
|                     | 250 x 50       | 9580250050 |
|                     | 250 x 63       | 9580250063 |
|                     | 250 x 90       | 9580250090 |
|                     | 315 x 90       | 9580315090 |

Artikelgroep: 01.02.30



|                     | Afmeting     | Artikelnr. |
|---------------------|--------------|------------|
| <b>9380</b>         | 63 x 1 1/4"  | 9380063114 |
| <b>Aanboorzadel</b> | 75 x 1 1/4"  | 9380075114 |
| - met messing       | 90 x 1 1/2"  | 9380090112 |
| binnendraad         | 90 x 2"      | 9380090200 |
|                     | 110 x 1 1/2" | 9380110112 |
|                     | 110 x 2"     | 9380110200 |
|                     | 125 x 1 1/2" | 9380125112 |
|                     | 125 x 2"     | 9380125200 |
|                     | 140 x 1 1/2" | 9380140112 |
|                     | 140 x 2"     | 9380140200 |
|                     | 160 x 1 1/2" | 9380160112 |
|                     | 160 x 2"     | 9380160200 |
|                     | 180 x 1 1/2" | 9380180112 |
|                     | 180 x 2"     | 9380180200 |
|                     | 200 x 2"     | 9380200200 |
|                     | 225 x 2"     | 9380225200 |
|                     | 250 x 2"     | 9380250200 |

Artikelgroep: 01.02.30



|                     | Afmeting     | Artikelnr. |
|---------------------|--------------|------------|
| <b>9680</b>         | 90 x 2 1/2"  | 9680090212 |
| <b>Ballon zadel</b> | 110 x 2 1/2" | 9680110212 |
|                     | 125 x 2 1/2" | 9680125212 |
|                     | 140 x 2 1/2" | 9680140212 |
|                     | 160 x 2 1/2" | 9680160212 |
|                     | 180 x 2 1/2" | 9680180212 |
|                     | 200 x 2 1/2" | 9680200212 |
|                     | 225 x 2 1/2" | 9680225212 |
|                     | 250 x 2 1/2" | 9680250212 |

Artikelgroep: 01.02.30

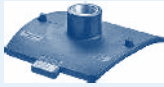


## Plasson elektrolas aanboorzadels



01

|                                 | Buisdiameter in mm | Artikelnr.             |
|---------------------------------|--------------------|------------------------|
| <b>9380L</b>                    | 250 - 400          | 9380L400200            |
| <b>Aanboorzadel</b>             | 450 - 800          | 9380L800200            |
| - voor grote diameter leidingen |                    | Artikelgroep: 01.02.30 |
| - met messing                   |                    |                        |
| 2" binnendraad                  |                    |                        |



\* Voor het monteren van dit aanboorzadel heeft u gespecialiseerd gereedschap nodig. Hiervoor verwijzen wij u naar Groep 21 'Machines en gereedschappen'.

|                                 | Buisdiameter in mm | Afmeting spie in mm | Artikelnr.  |
|---------------------------------|--------------------|---------------------|-------------|
| <b>9580L*</b>                   | 250 - 400          | 90                  | 9580L400090 |
| <b>Aanboorzadel</b>             | 250 - 400          | 110                 | 9580L400110 |
| - voor grote diameter leidingen | 250 - 400          | 125                 | 9580L400125 |
| - met spie-eind                 | 280 - 400          | 160                 | 9580L400160 |
|                                 | 450 - 800          | 90                  | 9580L800090 |
|                                 | 450 - 800          | 110                 | 9580L800110 |
|                                 | 450 - 800          | 125                 | 9580L800125 |
|                                 | 450 - 800          | 160                 | 9580L800160 |
|                                 | 500 - 630          | 250                 | 9580L630250 |
|                                 | 900                | 250                 | 9580L900250 |



Artikelgroep: 01.02.30

\* Voor het monteren van dit aanboorzadel heeft u gespecialiseerd gereedschap nodig. Hiervoor verwijzen wij u naar Groep 21 'Machines en gereedschappen'.

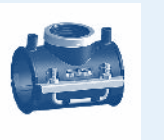
|                                 | Buisdiameter in mm | DN  | Artikelnr.  |
|---------------------------------|--------------------|-----|-------------|
| <b>9590L*</b>                   | 250 - 400          | 80  | 9590L400080 |
| <b>Aanboorzadel</b>             | 250 - 400          | 100 | 9590L400100 |
| - voor grote diameter leidingen | 250 - 400          | 125 | 9590L400125 |
| - met flens                     | 280 - 400          | 150 | 9590L400150 |
|                                 | 450 - 800          | 80  | 9590L800080 |
|                                 | 450 - 800          | 100 | 9590L800100 |
|                                 | 450 - 800          | 150 | 9590L800150 |
|                                 | 560 - 630          | 250 | 9590L630250 |



Artikelgroep: 01.02.30

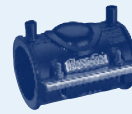
\* Voor het monteren van dit aanboorzadel heeft u gespecialiseerd gereedschap nodig. Hiervoor verwijzen wij u naar Groep 21 'Machines en gereedschappen'.

|                     | Afmeting    | Artikelnr. |
|---------------------|-------------|------------|
| <b>958T*</b>        | 63 x 3/4"   | 958T063034 |
| <b>Aanboorzadel</b> | 63 x 1"     | 958T063100 |
| <b>BSPP</b>         | 63 x 1 1/4" | 958T063114 |
| - met binnendraad   | 63 x 1 1/2" | 958T063112 |
|                     | 90 x 1"     | 958T090100 |
|                     | 90 x 1 1/4" | 958T090114 |
|                     | 90 x 1 1/2" | 958T090112 |



Artikelgroep: 01.02.30

|                       | Afmeting in mm | Artikelnr. |
|-----------------------|----------------|------------|
| <b>9520</b>           | 63             | 9520063    |
| <b>Reparatiezadel</b> | 75             | 9520075    |
|                       | 90             | 9520090    |
|                       | 110            | 9520110    |
|                       | 125            | 9520125    |
|                       | 140            | 9520140    |
|                       | 160            | 9520160    |
|                       | 180            | 9520180    |



Artikelgroep: 01.02.30

|                                   | Afmeting in mm | Artikelnr. |
|-----------------------------------|----------------|------------|
| <b>9630*</b>                      | 40 x 20        | 9630040020 |
| <b>Aanboorzadel met aftakking</b> | 40 x 25        | 9630040025 |
| - inclusief boor                  | 40 x 32        | 9630040032 |
| - aanboren onder druk mogelijk    | 50 x 20        | 9630050020 |
|                                   | 50 x 32        | 9630050032 |
|                                   | 63 x 20        | 9630063020 |
|                                   | 63 x 25        | 9630063025 |
|                                   | 63 x 32        | 9630063032 |
|                                   | 63 x 40        | 9630063040 |
|                                   | 63 x 50        | 9630063050 |
|                                   | 63 x 63        | 9630063063 |
|                                   | 75 x 20        | 9630075020 |
|                                   | 75 x 32        | 9630075032 |
|                                   | 75 x 40        | 9630075040 |
|                                   | 75 x 50        | 9630075050 |
|                                   | 75 x 63        | 9630075063 |
|                                   | 90 x 20        | 9630090020 |
|                                   | 90 x 32        | 9630090032 |
|                                   | 90 x 40        | 9630090040 |
|                                   | 90 x 50        | 9630090050 |
|                                   | 90 x 63        | 9630090063 |
|                                   | 110 x 20       | 9630110020 |
|                                   | 110 x 25       | 9630110025 |
|                                   | 110 x 32       | 9630110032 |
|                                   | 110 x 40       | 9630110040 |
|                                   | 110 x 50       | 9630110050 |
|                                   | 110 x 63       | 9630110063 |
|                                   | 125 x 20       | 9630125020 |
|                                   | 125 x 32       | 9630125032 |
|                                   | 125 x 40       | 9630125040 |
|                                   | 125 x 50       | 9630125050 |
|                                   | 125 x 63       | 9630125063 |
|                                   | 140 x 32       | 9630140032 |
|                                   | 140 x 40       | 9630140040 |
|                                   | 140 x 50       | 9630140050 |
|                                   | 140 x 63       | 9630140063 |
|                                   | 160 x 20       | 9630160020 |
|                                   | 160 x 32       | 9630160032 |
|                                   | 160 x 40       | 9630160040 |
|                                   | 160 x 50       | 9630160050 |
|                                   | 160 x 63       | 9630160063 |
|                                   | 180 x 20       | 9630180020 |
|                                   | 180 x 32       | 9630180032 |
|                                   | 180 x 40       | 9630180040 |
|                                   | 180 x 50       | 9630180050 |
|                                   | 180 x 63       | 9630180063 |
|                                   | 200 x 20       | 9630200020 |
|                                   | 200 x 32       | 9630200032 |
|                                   | 200 x 40       | 9630200040 |
|                                   | 200 x 50       | 9630200050 |
|                                   | 200 x 63       | 9630200063 |
|                                   | 225 x 20       | 9630225020 |
|                                   | 225 x 32       | 9630225032 |
|                                   | 225 x 40       | 9630225040 |
|                                   | 225 x 50       | 9630225050 |
|                                   | 225 x 63       | 9630225063 |
|                                   | 250 x 20       | 9630250020 |
|                                   | 250 x 32       | 9630250032 |
|                                   | 250 x 40       | 9630250040 |
|                                   | 250 x 50       | 9630250050 |
|                                   | 250 x 63       | 9630250063 |

\* Voor stalen imbusleutel elektrolas aanboorzadel zie groep 21 blz. 291, artikelnr. 9202.

Artikelgroep: 01.02.30



# 01.02 Fittingen voor PE drukleidingen

## Plasson elektrolasfittingen voor riooltoepassingen



01

|                          | Afmeting in mm | Artikelnr. |
|--------------------------|----------------|------------|
| <b>6010</b>              | 250            | 6010250    |
| <b>Mof Lightfit</b>      | 280            | 6010280    |
| - maximale druk van PN10 | 315            | 6010315    |
|                          | 355            | 6010355    |
|                          | 400            | 6010400    |
|                          | 450            | 6010450    |
|                          | 500            | 6010500    |
|                          | 560            | 6010560    |
|                          | 630            | 6010630    |
|                          | 710            | 6010710    |
|                          | 800            | 6010800    |
|                          | 900            | 6010900    |

Artikelgroep: 01.02.25



Andere afmetingen zijn op aanvraag leverbaar.

|                           | Afmeting in mm | Artikelnr. |
|---------------------------|----------------|------------|
| <b>7580*</b>              | 200 x 160      | 7580200160 |
| <b>Riool afvoorzadel</b>  | 225/250 x 160  | 7580250160 |
| - met flexibele koppeling | 280/315 x 160  | 7580315160 |
|                           | 355/560 x 160  | 7580560160 |
|                           | 560/710 x 160  | 7580710160 |

Artikelgroep: 01.02.31



\* Voor het monteren van dit aanboorzadel heeft u gespecialiseerd gereedschap nodig. Hiervoor verwijzen wij u naar Groep 21 'Machines en gereedschappen'.

|                              | Afmeting in mm | Artikelnr.             |
|------------------------------|----------------|------------------------|
| <b>758A*</b>                 | 160/200 x 110  | 758A160110             |
| <b>Riool afvoorzadel 45°</b> | 225/315 x 110  | 758A250110             |
| - met aftakking 110mm        |                | Artikelgroep: 01.02.31 |



\* Voor het monteren van dit aanboorzadel heeft u gespecialiseerd gereedschap nodig. Hiervoor verwijzen wij u naar Groep 21 'Machines en gereedschappen'.

|                                  | Afmeting in mm | Artikelnr.             |
|----------------------------------|----------------|------------------------|
| <b>747D</b>                      | 160            | 747D160                |
| <b>Riool flexibele koppeling</b> |                | Artikelgroep: 01.02.31 |
| - 1 x mof, 1 x spie              |                |                        |



|                                  | Afmeting in mm | Artikelnr. |
|----------------------------------|----------------|------------|
| <b>3702</b>                      | 160            | 3702160    |
| <b>PE Riool putwand-doorvoer</b> | 180            | 3702180    |
| - voor betonput                  | 200            | 3702200    |
|                                  | 225            | 3702225    |
|                                  | 250            | 3702250    |
|                                  | 280            | 3702280    |
|                                  | 315            | 3702315    |
|                                  | 355            | 3702355    |
|                                  | 400            | 3702400    |


Artikelgroep: 01.02.31



|                                  | Afmeting in mm | Artikelnr.             |
|----------------------------------|----------------|------------------------|
| <b>701V</b>                      | 160            | 701V160                |
| <b>Riool overgangs-koppeling</b> |                | Artikelgroep: 01.02.31 |
| - PE x PVC                       |                |                        |



|                                  | Afmeting in mm | Artikelnr.             |
|----------------------------------|----------------|------------------------|
| <b>747V</b>                      | 160            | 747V160                |
| <b>Riool flexibele koppeling</b> |                | Artikelgroep: 01.02.31 |
| - PE x PVC                       |                |                        |





# 01.02 Fittingen voor PE drukleidingen

## PE Drukfittingen SDR17 met lange spie-einden

• Voor grotere afmetingen in PE fittingen, vragen wij u contact op te nemen met onze verkoopmedewerkers.

01

|                                  | Afmeting in mm | Artikelnr. |
|----------------------------------|----------------|------------|
| <b>620</b>                       | 75 x 40        | 620075040  |
| <b>PE Verloopstuk</b>            | 75 x 50        | 620075050  |
| - lange spie-einden              | 75 x 63        | 620075063  |
| - centrisch                      | 90 x 50        | 620090050  |
| - voor elektrolas en spiegelglas | 90 x 63        | 620090063  |
| - PE 100                         | 90 x 75        | 620090075  |
| - SDR17                          | 110 x 63       | 620110063  |
|                                  | 110 x 75       | 620110075  |
|                                  | 110 x 90       | 620110090  |
|                                  | 125 x 63       | 620125063  |
|                                  | 125 x 75       | 620125075  |
|                                  | 125 x 90       | 620125090  |
|                                  | 125 x 110      | 620125110  |
|                                  | 140 x 75       | 620140075  |
|                                  | 140 x 90       | 620140090  |
|                                  | 140 x 110      | 620140110  |
|                                  | 140 x 125      | 620140125  |
|                                  | 160 x 90       | 620160090  |
|                                  | 160 x 110      | 620160110  |
|                                  | 160 x 125      | 620160125  |
|                                  | 160 x 140      | 620160140  |
|                                  | 180 x 125      | 620180125  |
|                                  | 180 x 160      | 620180160  |
|                                  | 200 x 125      | 620200125  |
|                                  | 200 x 160      | 620200160  |
|                                  | 200 x 180      | 620200180  |
|                                  | 225 x 110      | 620225110  |
|                                  | 225 x 160      | 620225160  |
|                                  | 225 x 180      | 620225180  |
|                                  | 225 x 200      | 620225200  |
|                                  | 250 x 160      | 620250160  |
|                                  | 250 x 180      | 620250180  |
|                                  | 250 x 200      | 620250200  |
|                                  | 250 x 225      | 620250225  |
|                                  | 280 x 180      | 620280180  |
|                                  | 280 x 200      | 620280200  |
|                                  | 280 x 225      | 620280225  |
|                                  | 280 x 250      | 620280250  |
|                                  | 315 x 200      | 620315200  |
|                                  | 315 x 225      | 620315225  |
|                                  | 315 x 250      | 620315250  |
|                                  | 315 x 280      | 620315280  |
|                                  | 355 x 225      | 620355225  |
|                                  | 355 x 250      | 620355250  |
|                                  | 355 x 280      | 620355280  |
|                                  | 355 x 315      | 620355315  |
|                                  | 400 x 280      | 620400280  |
|                                  | 400 x 315      | 620400315  |
|                                  | 400 x 355      | 620400355  |
|                                  | 450 x 315      | 620450315  |
|                                  | 450 x 400      | 620450400  |
|                                  | 500 x 355      | 620500355  |
|                                  | 500 x 400      | 620500400  |
|                                  | 500 x 450      | 620500450  |



Artikelgroep: 01.02.40

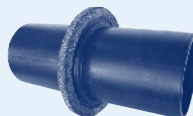
|                                  | Afmeting in mm | Artikelnr. |
|----------------------------------|----------------|------------|
| <b>690</b>                       | 50             | 690050     |
| <b>PE Voorlaskraag</b>           | 63             | 690063     |
| - lang spie-eind                 | 75             | 690075     |
| - voor elektrolas en spiegelglas | 90             | 690090     |
| - PE 100                         | 110            | 690110     |
| - SDR17                          | 125            | 690125     |
|                                  | 140            | 690140     |
|                                  | 160            | 690160     |
|                                  | 180            | 690180     |
|                                  | 200            | 690200     |
|                                  | 225            | 690225     |
|                                  | 250            | 690250     |
|                                  | 280            | 690280     |
|                                  | 315            | 690315     |
|                                  | 355            | 690355     |
|                                  | 400            | 690400     |
|                                  | 450            | 690450     |
|                                  | 500            | 690500     |
|                                  | 560            | 690560     |
|                                  | 630            | 690630     |
|                                  | 710            | 690710     |



Artikelgroep: 01.02.40

|   | Afmeting in mm | Artikelnr. |
|---|----------------|------------|
| <b>696*</b>                                     | 90             | 696090     |
| <b>PE Wanddoorvoer</b>                          | 110            | 696110     |
| - met gezande flens                             | 125            | 696125     |
| - voor elektrolas en spiegelglas                | 160            | 696160     |
| - aan beide zijden                              | 200            | 696200     |
| voorzien van 0,5 meter aangelaste PE buis SDR17 | 250            | 696250     |
|   | 315            | 696315     |
|   | 400            | 696400     |

Artikelgroep: 01.02.40



\* Voor PSI instortflens zie blz. 63, Fig. 210.


|                                  | Afmeting in mm | Artikelnr. |
|----------------------------------|----------------|------------|
| <b>9127</b>                      | 20             | 9127020    |
| <b>PE Eindplug</b>               | 25             | 9127025    |
| - lang spie-eind                 | 32             | 9127032    |
| - voor elektrolas en spiegelglas | 40             | 9127040    |
| - PE 100                         | 50             | 9127050    |
| - SDR11                          | 63             | 9127063    |
|                                  | 75             | 9127075    |
|                                  | 90             | 9127090    |
|                                  | 110            | 9127110    |
|                                  | 125            | 9127125    |
|                                  | 140            | 9127140    |
|                                  | 160            | 9127160    |
|                                  | 180            | 9127180    |
|                                  | 200            | 9127200    |
|                                  | 225            | 9127225    |
|                                  | 250            | 9127250    |
|                                  | 280            | 9127280    |
|                                  | 315            | 9127315    |
|                                  | 355            | 9127355    |
|                                  | 400            | 9127400    |
|                                  | 500            | 9127500    |
|                                  | 560            | 9127560    |



Artikelgroep: 01.02.25

## PE Drukfittingen SDR17 met lange spie-einden

|                                 | Afmeting in mm | Artikelnr. |
|---------------------------------|----------------|------------|
| <b>650</b>                      | 50             | 650050     |
| <b>PE Knie 90°</b>              | 63             | 650063     |
| - lange spie-einden             | 75             | 650075     |
| - voor elektrolas en spiegelass | 90             | 650090     |
| - PE 100                        | 110            | 650110     |
| - SDR17                         | 125            | 650125     |
|                                 | 140            | 650140     |
|                                 | 160            | 650160     |
|                                 | 180            | 650180     |
|                                 | 200            | 650200     |
|                                 | 225            | 650225     |
|                                 | 250            | 650250     |
|                                 | 280            | 650280     |
|                                 | 315            | 650315     |
|                                 | 355            | 650355     |
|                                 | 400            | 650400     |
|                                 | 450            | 650450     |
|                                 | 500            | 650500     |




Artikelgroep: 01.02.40

|                                 | Afmeting in mm | Artikelnr. |
|---------------------------------|----------------|------------|
| <b>615</b>                      | 50             | 615050     |
| <b>PE Knie 45°</b>              | 63             | 615063     |
| - lange spie-einden             | 75             | 615075     |
| - voor elektrolas en spiegelass | 90             | 615090     |
| - PE 100                        | 110            | 615110     |
| - SDR17                         | 125            | 615125     |
|                                 | 140            | 615140     |
|                                 | 160            | 615160     |
|                                 | 180            | 615180     |
|                                 | 200            | 615200     |
|                                 | 225            | 615225     |
|                                 | 250            | 615250     |
|                                 | 280            | 615280     |
|                                 | 315            | 615315     |
|                                 | 355            | 615355     |
|                                 | 400            | 615400     |
|                                 | 450            | 615450     |
|                                 | 500            | 615500     |




Artikelgroep: 01.02.40

|                                 | Afmeting in mm | Artikelnr. |
|---------------------------------|----------------|------------|
| <b>640</b>                      | 50             | 640050     |
| <b>PE T-stuk 90°</b>            | 63             | 640063     |
| - lange spie-einden             | 75             | 640075     |
| - voor elektrolas en spiegelass | 90             | 640090     |
| - PE 100                        | 110            | 640110     |
| - SDR17                         | 125            | 640125     |
|                                 | 140            | 640140     |
|                                 | 160            | 640160     |
|                                 | 180            | 640180     |
|                                 | 200            | 640200     |
|                                 | 225            | 640225     |
|                                 | 250            | 640250     |
|                                 | 280            | 640280     |
|                                 | 315            | 640315     |
|                                 | 355            | 640355     |
|                                 | 400            | 640400     |
|                                 | 450            | 640450     |
|                                 | 500            | 640500     |




Artikelgroep: 01.02.40

|                                 | Afmeting in mm  | Artikelnr. |
|---------------------------------|-----------------|------------|
| <b>644</b>                      | 110 x 63 x 110  | 644110063  |
| <b>PE Verloop T-stuk 90°</b>    | 110 x 75 x 110  | 644110075  |
| - lange spie-einden             | 110 x 90 x 110  | 644110090  |
| - voor elektrolas en spiegelass | 125 x 63 x 125  | 644125063  |
| - PE 100                        | 125 x 75 x 125  | 644125075  |
| - SDR17                         | 125 x 90 x 125  | 644125090  |
|                                 | 125 x 110 x 125 | 644125110  |
|                                 | 140 x 63 x 140  | 644140063  |
|                                 | 140 x 75 x 140  | 644140075  |
|                                 | 140 x 90 x 140  | 644140090  |
|                                 | 140 x 110 x 140 | 644140110  |
|                                 | 160 x 63 x 160  | 644160063  |
|                                 | 160 x 75 x 160  | 644160075  |
|                                 | 160 x 90 x 160  | 644160090  |
|                                 | 160 x 110 x 160 | 644160110  |
|                                 | 180 x 75 x 180  | 644180075  |
|                                 | 180 x 90 x 180  | 644180090  |
|                                 | 180 x 110 x 180 | 644180110  |
|                                 | 180 x 125 x 180 | 644180125  |
|                                 | 180 x 140 x 180 | 644180140  |
|                                 | 180 x 160 x 180 | 644180160  |
|                                 | 200 x 63 x 200  | 644200063  |
|                                 | 200 x 75 x 200  | 644200075  |
|                                 | 200 x 90 x 200  | 644200090  |
|                                 | 200 x 110 x 200 | 644200110  |
|                                 | 200 x 125 x 200 | 644200125  |
|                                 | 200 x 160 x 200 | 644200160  |
|                                 | 225 x 63 x 225  | 644225063  |
|                                 | 225 x 75 x 225  | 644225075  |
|                                 | 225 x 90 x 225  | 644225090  |
|                                 | 225 x 110 x 225 | 644225110  |
|                                 | 225 x 125 x 225 | 644225125  |
|                                 | 225 x 140 x 225 | 644225140  |
|                                 | 225 x 160 x 225 | 644225160  |
|                                 | 250 x 90 x 250  | 644250090  |
|                                 | 250 x 110 x 250 | 644250110  |
|                                 | 250 x 125 x 250 | 644250125  |
|                                 | 250 x 160 x 250 | 644250160  |
|                                 | 280 x 160 x 280 | 644280160  |
|                                 | 315 x 90 x 315  | 644315090  |
|                                 | 315 x 110 x 315 | 644315110  |
|                                 | 315 x 125 x 315 | 644315125  |
|                                 | 315 x 160 x 315 | 644315160  |
|                                 | 315 x 250 x 315 | 644315250  |
|                                 | 355 x 250 x 355 | 644355250  |
|                                 | 355 x 280 x 355 | 644355280  |
|                                 | 355 x 315 x 355 | 644355315  |
|                                 | 400 x 280 x 400 | 644400280  |
|                                 | 400 x 315 x 400 | 644400315  |
|                                 | 400 x 355 x 400 | 644400355  |
|                                 | 500 x 355 x 500 | 644500355  |
|                                 | 500 x 400 x 500 | 644500400  |
|                                 | 500 x 450 x 500 | 644500450  |



Artikelgroep: 01.02.40

|                                   | Afmeting in mm | Artikelnr. |
|-----------------------------------|----------------|------------|
| <b>641</b>                        | 40             | 641040     |
| <b>PE T-stuk 45° spuitgegoten</b> | 50             | 641050     |
| - lange spie-einden               | 63             | 641063     |
| - voor elektrolas en spiegelass   | 75             | 641075     |
| - PE 100                          | 90             | 641090     |
| - SDR17                           | 110            | 641110     |
|                                   | 125            | 641125     |
|                                   | 160            | 641160     |
|                                   | 180            | 641180     |
|                                   | 200            | 641200     |
|                                   | 200*           | 641201     |
|                                   | 225            | 641225     |
|                                   | 250*           | 641250     |
|                                   | 315*           | 641315     |



Artikelgroep: 01.02.41

\* Segment T-stuk

# 01.02 Fittingen voor PE drukleidingen

## PE Drukfittingen SDR17 kort model

01

|                       | Afmeting in mm | Artikelnr. |
|-----------------------|----------------|------------|
| <b>675</b>            | 50 x 40        | 675050040  |
| <b>PE Verloopstuk</b> | 63 x 32        | 675063032  |
| - kort model          | 63 x 40        | 675063040  |
| - centrisch           | 63 x 50        | 675063050  |
| - voor spiegellas     | 75 x 40        | 675075040  |
| - PE 100              | 75 x 50        | 675075050  |
| - SDR17               | 75 x 63        | 675075063  |
|                       | 90 x 50        | 675090050  |
|                       | 90 x 63        | 675090063  |
|                       | 90 x 75        | 675090075  |
|                       | 110 x 50       | 675110050  |
|                       | 110 x 63       | 675110063  |
|                       | 110 x 75       | 675110075  |
|                       | 110 x 90       | 675110090  |
|                       | 125 x 63       | 675125063  |
|                       | 125 x 75       | 675125075  |
|                       | 125 x 90       | 675125090  |
|                       | 125 x 110      | 675125110  |
|                       | 140 x 75       | 675140075  |
|                       | 140 x 90       | 675140090  |
|                       | 140 x 110      | 675140110  |
|                       | 140 x 125      | 675140125  |
|                       | 160 x 90       | 675160090  |
|                       | 160 x 110      | 675160110  |
|                       | 160 x 125      | 675160125  |
|                       | 160 x 140      | 675160140  |
|                       | 180 x 90       | 675180090  |
|                       | 180 x 110      | 675180110  |
|                       | 180 x 125      | 675180125  |
|                       | 180 x 140      | 675180140  |
|                       | 180 x 160      | 675180160  |
|                       | 200 x 125      | 675200125  |
|                       | 200 x 140      | 675200140  |
|                       | 200 x 160      | 675200160  |
|                       | 200 x 180      | 675200180  |
|                       | 225 x 110      | 675225110  |
|                       | 225 x 140      | 675225140  |
|                       | 225 x 160      | 675225160  |
|                       | 225 x 180      | 675225180  |
|                       | 225 x 200      | 675225200  |
|                       | 250 x 160      | 675250160  |
|                       | 250 x 180      | 675250180  |
|                       | 250 x 200      | 675250200  |
|                       | 250 x 225      | 675250225  |
|                       | 280 x 180      | 675280180  |
|                       | 280 x 200      | 675280200  |
|                       | 280 x 225      | 675280225  |
|                       | 280 x 250      | 675280250  |
|                       | 315 x 200      | 675315200  |
|                       | 315 x 225      | 675315225  |
|                       | 315 x 250      | 675315250  |
|                       | 315 x 280      | 675315280  |
|                       | 355 x 225      | 675355225  |
|                       | 355 x 250      | 675355250  |
|                       | 355 x 280      | 675355280  |
|                       | 355 x 315      | 675355315  |
|                       | 400 x 280      | 675400280  |
|                       | 400 x 315      | 675400315  |
|                       | 400 x 355      | 675400355  |
|                       | 450 x 315      | 675450315  |
|                       | 450 x 355      | 675450355  |
|                       | 450 x 400      | 675450400  |
|                       | 500 x 315      | 675500315  |
|                       | 500 x 355      | 675500355  |
|                       | 500 x 400      | 675500400  |
|                       | 500 x 450      | 675500450  |
|                       | 560 x 400      | 675560400  |
|                       | 560 x 450      | 675560450  |
|                       | 560 x 500      | 675560500  |
|                       | 630 x 450      | 675630450  |
|                       | 630 x 500      | 675630500  |
|                       | 630 x 560      | 675630560  |
|                       | 710 x 500      | 675710500  |
|                       | 710 x 560      | 675710560  |
|                       | 710 x 630      | 675710630  |
|                       | 800 x 630      | 675800630  |
|                       | 800 x 710      | 675800710  |
|                       | 900 x 800      | 675900800  |



Artikelgroep: 01.02.40

|                        | Afmeting in mm | Artikelnr. |
|------------------------|----------------|------------|
| <b>685</b>             | 50             | 685050     |
| <b>PE Voorlaskraag</b> | 63             | 685063     |
| - kort model           | 75             | 685075     |
| - voor spiegellas      | 90             | 685090     |
| - PE 100               | 110            | 685110     |
| - SDR17                | 125            | 685125     |
|                        | 140            | 685140     |
|                        | 160            | 685160     |
|                        | 180            | 685180     |
|                        | 200            | 685200     |
|                        | 225            | 685225     |
|                        | 250            | 685250     |
|                        | 280            | 685280     |
|                        | 315            | 685315     |
|                        | 355            | 685355     |
|                        | 400            | 685400     |
|                        | 450            | 685450     |
|                        | 500            | 685500     |
|                        | 560            | 685560     |
|                        | 630            | 685630     |
|                        | 710            | 685710     |
|                        | 800            | 685800     |
|                        | 900            | 685900     |



Artikelgroep: 01.02.40

|                     | Afmeting in mm | Artikelnr. |
|---------------------|----------------|------------|
| <b>625</b>          | 50             | 625050     |
| <b>PE Bocht 90°</b> | 63             | 625063     |
| - r=d               | 75             | 625075     |
| - voor spiegellas   | 90             | 625090     |
| - PE 100            | 110            | 625110     |
| - SDR17             | 125            | 625125     |
|                     | 140            | 625140     |
|                     | 160            | 625160     |
|                     | 180            | 625180     |
|                     | 200            | 625200     |
|                     | 225            | 625225     |
|                     | 250            | 625250     |
|                     | 280            | 625280     |
|                     | 315            | 625315     |
|                     | 355            | 625355     |
|                     | 400            | 625400     |



Artikelgroep: 01.02.40

|                      | Afmeting in mm | Artikelnr. |
|----------------------|----------------|------------|
| <b>670</b>           | 50             | 670050     |
| <b>PE T-stuk 90°</b> | 63             | 670063     |
| - kort model         | 75             | 670075     |
| - voor spiegellas    | 90             | 670090     |
| - PE 100             | 110            | 670110     |
| - SDR17              | 125            | 670125     |
|                      | 140            | 670140     |
|                      | 160            | 670160     |
|                      | 180            | 670180     |
|                      | 200            | 670200     |
|                      | 225            | 670225     |
|                      | 250            | 670250     |
|                      | 280            | 670280     |
|                      | 315            | 670315     |
|                      | 355            | 670355     |
|                      | 400            | 670400     |
|                      | 450            | 670450     |
|                      | 500            | 670500     |



Artikelgroep: 01.02.40

## PE Drukfittingen SDR17 r=1,5d

|                      | Afmeting in mm | Artikelnr. |
|----------------------|----------------|------------|
| <b>635</b>           | 50             | 635050     |
| <b>PE Bocht 90°</b>  | 63             | 635063     |
| - r=1,5d             | 75             | 635075     |
| - lange spie-einden  | 90             | 635090     |
| - naadloos uit buis  | 110            | 635110     |
| getrokken            | 125            | 635125     |
| - voor elektrolas en | 140            | 635140     |
| spiegelllas          | 160            | 635160     |
| - PE 100             | 180            | 635180     |
| - SDR17              | 200            | 635200     |
|                      | 225            | 635225     |
|                      | 250            | 635250     |
|                      | 280            | 635280     |
|                      | 315            | 635315     |
|                      | 355            | 635355     |
|                      | 400            | 635400     |
|                      | 450            | 635450     |
|                      | 500            | 635500     |
|                      | 560            | 635560     |
|                      | 630            | 635630     |
|                      | 710            | 635710     |
|                      | 800            | 635800     |
|                      | 900            | 635900     |
|                      | 1000           | 635990     |

Artikelgroep: 01.02.42



|                      | Afmeting in mm | Artikelnr. |
|----------------------|----------------|------------|
| <b>665</b>           | 50             | 665050     |
| <b>PE Bocht 45°</b>  | 63             | 665063     |
| - r=1,5d             | 75             | 665075     |
| - lange spie-einden  | 90             | 665090     |
| - naadloos uit buis  | 110            | 665110     |
| getrokken            | 125            | 665125     |
| - voor elektrolas en | 140            | 665140     |
| spiegelllas          | 160            | 665160     |
| - PE 100             | 180            | 665180     |
| - SDR17              | 200            | 665200     |
|                      | 225            | 665225     |
|                      | 250            | 665250     |
|                      | 280            | 665280     |
|                      | 315            | 665315     |
|                      | 355            | 665355     |
|                      | 400            | 665400     |
|                      | 450            | 665450     |
|                      | 500            | 665500     |
|                      | 560            | 665560     |
|                      | 630            | 665630     |
|                      | 710            | 665710     |
|                      | 800            | 665800     |
|                      | 900            | 665900     |
|                      | 1000           | 665990     |

Artikelgroep: 01.02.42



|                      | Afmeting in mm | Artikelnr. |
|----------------------|----------------|------------|
| <b>667*</b>          | 50             | 667050     |
| <b>PE Bocht 30°</b>  | 63             | 667063     |
| - r=1,5d             | 75             | 667075     |
| - lange spie-einden  | 90             | 667090     |
| - naadloos uit buis  | 110            | 667110     |
| getrokken            | 125            | 667125     |
| - voor elektrolas en | 140            | 667140     |
| spiegelllas          | 160            | 667160     |
| - PE 100             | 180            | 667180     |
| - SDR17              | 200            | 667200     |
|                      | 225            | 667225     |
|                      | 250            | 667250     |
|                      | 280            | 667280 ↗   |

|                     | Afmeting in mm | Artikelnr. |
|---------------------|----------------|------------|
| <b>Vervolg 667*</b> | 315            | 667315     |
|                     | 355            | 667355     |
|                     | 400            | 667400     |
|                     | 450            | 667450     |
|                     | 500            | 667500     |
|                     | 560            | 667560     |
|                     | 630            | 667630     |
|                     | 710            | 667710     |
|                     | 800            | 667800     |
|                     | 900            | 667900     |
|                     | 1000           | 667990     |

Artikelgroep: 01.02.42



\* Artikelnr. 663: PE Bocht 60° r=1,5d op aanvraag leverbaar.

|                      | Afmeting in mm | Artikelnr. |
|----------------------|----------------|------------|
| <b>668</b>           | 50             | 668050     |
| <b>PE Bocht 22°</b>  | 63             | 668063     |
| - r=1,5d             | 75             | 668075     |
| - lange spie-einden  | 90             | 668090     |
| - naadloos uit buis  | 110            | 668110     |
| getrokken            | 125            | 668125     |
| - voor elektrolas en | 140            | 668140     |
| spiegelllas          | 160            | 668160     |
| - PE 100             | 180            | 668180     |
| - SDR17              | 200            | 668200     |
|                      | 225            | 668225     |
|                      | 250            | 668250     |
|                      | 280            | 668280     |
|                      | 315            | 668315     |
|                      | 355            | 668355     |
|                      | 400            | 668400     |
|                      | 450            | 668450     |
|                      | 500            | 668500     |
|                      | 560            | 668560     |
|                      | 630            | 668630     |
|                      | 710            | 668710     |
|                      | 800            | 668800     |
|                      | 900            | 668900     |
|                      | 1000           | 668990     |

Artikelgroep: 01.02.42



|                      | Afmeting in mm | Artikelnr. |
|----------------------|----------------|------------|
| <b>669</b>           | 50             | 669050     |
| <b>PE Bocht 11°</b>  | 63             | 669063     |
| - r=1,5d             | 75             | 669075     |
| - lange spie-einden  | 90             | 669090     |
| - naadloos uit buis  | 110            | 669110     |
| getrokken            | 125            | 669125     |
| - voor elektrolas en | 140            | 669140     |
| spiegelllas          | 160            | 669160     |
| - PE 100             | 180            | 669180     |
| - SDR17              | 200            | 669200     |
|                      | 225            | 669225     |
|                      | 250            | 669250     |
|                      | 280            | 669280     |
|                      | 315            | 669315     |
|                      | 355            | 669355     |
|                      | 400            | 669400     |
|                      | 450            | 669450     |
|                      | 500            | 669500     |
|                      | 560            | 669560     |
|                      | 630            | 669630     |
|                      | 710            | 669710     |
|                      | 800            | 669800     |
|                      | 900            | 669900     |
|                      | 1000           | 669990     |

Artikelgroep: 01.02.42



# 01.02 Fittingen voor PE drukleidingen

## PE Drukfittingen SDR11 met lange spie-einden

• Voor grotere afmetingen in PE fittingen vragen wij u contact op te nemen met onze verkoopmedewerkers.

01

|                                 | Afmeting in mm | Artikelnr. |
|---------------------------------|----------------|------------|
| <b>120</b>                      | 25 x 20        | 120025020  |
| <b>PE Verloopstuk</b>           | 32 x 20        | 120032020  |
| - lange spie-einden             | 32 x 25        | 120032025  |
| - centrisch                     | 40 x 20        | 120040020  |
| - voor elektrolas en spiegellas | 40 x 25        | 120040025  |
| - PE 100                        | 40 x 32        | 120040032  |
| - SDR11                         | 50 x 25        | 120050025  |
|                                 | 50 x 32        | 120050032  |
|                                 | 50 x 40        | 120050040  |
|                                 | 63 x 32        | 120063032  |
|                                 | 63 x 40        | 120063040  |
|                                 | 63 x 50        | 120063050  |
|                                 | 75 x 40        | 120075040  |
|                                 | 75 x 50        | 120075050  |
|                                 | 75 x 63        | 120075063  |
|                                 | 90 x 50        | 120090050  |
|                                 | 90 x 63        | 120090063  |
|                                 | 90 x 75        | 120090075  |
|                                 | 110 x 63       | 120110063  |
|                                 | 110 x 75       | 120110075  |
|                                 | 110 x 90       | 120110090  |
|                                 | 125 x 63       | 120125063  |
|                                 | 125 x 75       | 120125075  |
|                                 | 125 x 90       | 120125090  |
|                                 | 125 x 110      | 120125110  |
|                                 | 140 x 75       | 120140075  |
|                                 | 140 x 90       | 120140090  |
|                                 | 140 x 110      | 120140110  |
|                                 | 140 x 125      | 120140125  |
|                                 | 160 x 90       | 120160090  |
|                                 | 160 x 110      | 120160110  |
|                                 | 160 x 125      | 120160125  |
|                                 | 160 x 140      | 120160140  |
|                                 | 180 x 125      | 120180125  |
|                                 | 180 x 160      | 120180160  |
|                                 | 200 x 125      | 120200125  |
|                                 | 200 x 140      | 120200140  |
|                                 | 200 x 160      | 120200160  |
|                                 | 200 x 180      | 120200180  |
|                                 | 225 x 110      | 120225110  |
|                                 | 225 x 160      | 120225160  |
|                                 | 225 x 180      | 120225180  |
|                                 | 225 x 200      | 120225200  |
|                                 | 250 x 160      | 120250160  |
|                                 | 250 x 180      | 120250180  |
|                                 | 250 x 200      | 120250200  |
|                                 | 250 x 225      | 120250225  |
|                                 | 280 x 180      | 120280180  |
|                                 | 280 x 200      | 120280200  |
|                                 | 280 x 225      | 120280225  |
|                                 | 280 x 250      | 120280250  |
|                                 | 315 x 200      | 120315200  |
|                                 | 315 x 225      | 120315225  |
|                                 | 315 x 250      | 120315250  |
|                                 | 315 x 280      | 120315280  |
|                                 | 355 x 225      | 120355225  |
|                                 | 355 x 250      | 120355250  |
|                                 | 355 x 280      | 120355280  |
|                                 | 355 x 315      | 120355315  |
|                                 | 400 x 280      | 120400280  |
|                                 | 400 x 315      | 120400315  |
|                                 | 400 x 355      | 120400355  |
|                                 | 450 x 400      | 120450400  |
|                                 | 500 x 315      | 120500315  |
|                                 | 500 x 400      | 120500400  |
|                                 | 500 x 450      | 120500450  |

Artikelgroep: 01.02.45



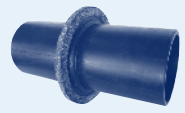
|                                 | Afmeting in mm | Artikelnr. |
|---------------------------------|----------------|------------|
| <b>180</b>                      | 20             | 180020     |
| <b>PE Voorlaskraag</b>          | 25             | 180025     |
| - lang spie-eind                | 32             | 180032     |
| - voor elektrolas en spiegellas | 40             | 180040     |
| - PE 100                        | 50             | 180050     |
| - SDR11                         | 63             | 180063     |
|                                 | 75             | 180075     |
|                                 | 90             | 180090     |
|                                 | 110            | 180110     |
|                                 | 125            | 180125     |
|                                 | 140            | 180140     |
|                                 | 160            | 180160     |
|                                 | 180            | 180180     |
|                                 | 200            | 180200     |
|                                 | 225            | 180225     |
|                                 | 250            | 180250     |
|                                 | 280            | 180280     |
|                                 | 315            | 180315     |
|                                 | 355            | 180355     |
|                                 | 400            | 180400     |
|                                 | 450            | 180450     |
|                                 | 500            | 180500     |
|                                 | 560            | 180560     |
|                                 | 630            | 180630     |
|                                 | 710            | 180710     |

Artikelgroep: 01.02.45



|   | Afmeting in mm | Artikelnr. |
|---|----------------|------------|
| <b>196*</b>                                     | 90             | 196090     |
| <b>PE Wanddoorvoer</b>                          | 110            | 196110     |
| - met gezande flens                             | 125            | 196125     |
| - voor elektrolas en spiegellas                 | 140            | 196140     |
| - aan beide zijde                               | 160            | 196160     |
| voorzien van 0,5 meter aangelaste PE buis SDR11 | 200            | 196200     |
|   | 250            | 196250     |
|   | 315            | 196315     |
|   | 400            | 196400     |

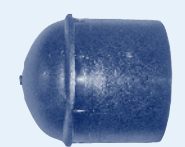
Artikelgroep: 01.02.45



\* Voor PSI instortflens zie blz. 63, Fig. 210.

|                                 | Afmeting in mm | Artikelnr. |
|---------------------------------|----------------|------------|
| <b>9127</b>                     | 20             | 9127020    |
| <b>PE Eindplug</b>              | 25             | 9127025    |
| - lang spie-eind                | 32             | 9127032    |
| - voor elektrolas en spiegellas | 40             | 9127040    |
| - PE 100                        | 50             | 9127050    |
| - SDR11                         | 63             | 9127063    |
|                                 | 75             | 9127075    |
|                                 | 90             | 9127090    |
|                                 | 110            | 9127110    |
|                                 | 125            | 9127125    |
|                                 | 140            | 9127140    |
|                                 | 160            | 9127160    |
|                                 | 180            | 9127180    |
|                                 | 200            | 9127200    |
|                                 | 225            | 9127225    |
|                                 | 250            | 9127250    |
|                                 | 280            | 9127280    |
|                                 | 315            | 9127315    |
|                                 | 355            | 9127355    |
|                                 | 400            | 9127400    |
|                                 | 450            | 9127450    |
|                                 | 500*           | 9127500    |
|                                 | 560*           | 9127560    |


Artikelgroep: 01.02.25



\* SDR17

## PE Drukfittingen SDR11 met lange spie-einden

|                                 | Afmeting in mm | Artikelnr. |
|---------------------------------|----------------|------------|
| <b>150</b>                      | 20             | 150020     |
| <b>PE Knie 90°</b>              | 25             | 150025     |
| - lange spie-einden             | 32             | 150032     |
| - voor elektrolas en spiegellas | 40             | 150040     |
| - PE 100                        | 50             | 150050     |
| - SDR11                         | 63             | 150063     |
|                                 | 75             | 150075     |
|                                 | 90             | 150090     |
|                                 | 110            | 150110     |
|                                 | 125            | 150125     |
|                                 | 140            | 150140     |
|                                 | 160            | 150160     |
|                                 | 180            | 150180     |
|                                 | 200            | 150200     |
|                                 | 225            | 150225     |
|                                 | 250            | 150250     |
|                                 | 280            | 150280     |
|                                 | 315            | 150315     |
|                                 | 355            | 150355     |
|                                 | 400            | 150400     |
|                                 | 450            | 150450     |
|                                 | 500            | 150500     |



Artikelgroep: 01.02.45

|                                 | Afmeting in mm | Artikelnr. |
|---------------------------------|----------------|------------|
| <b>115</b>                      | 20             | 115020     |
| <b>PE Knie 45°</b>              | 25             | 115025     |
| - lange spie-einden             | 32             | 115032     |
| - voor elektrolas en spiegellas | 40             | 115040     |
| - PE 100                        | 50             | 115050     |
| - SDR11                         | 63             | 115063     |
|                                 | 75             | 115075     |
|                                 | 90             | 115090     |
|                                 | 110            | 115110     |
|                                 | 125            | 115125     |
|                                 | 140            | 115140     |
|                                 | 160            | 115160     |
|                                 | 180            | 115180     |
|                                 | 200            | 115200     |
|                                 | 225            | 115225     |
|                                 | 250            | 115250     |
|                                 | 280            | 115280     |
|                                 | 315            | 115315     |
|                                 | 355            | 115355     |
|                                 | 400            | 115400     |
|                                 | 450            | 115450     |
|                                 | 500            | 115500     |



Artikelgroep: 01.02.45

|                                 | Afmeting in mm | Artikelnr. |
|---------------------------------|----------------|------------|
| <b>140</b>                      | 20             | 140020     |
| <b>PE T-stuk 90°</b>            | 25             | 140025     |
| - lange spie-einden             | 32             | 140032     |
| - voor elektrolas en spiegellas | 40             | 140040     |
| - PE 100                        | 50             | 140050     |
| - SDR11                         | 63             | 140063     |
|                                 | 75             | 140075     |
|                                 | 90             | 140090     |
|                                 | 110            | 140110     |
|                                 | 125            | 140125     |
|                                 | 140            | 140140     |
|                                 | 160            | 140160     |
|                                 | 180            | 140180     |
|                                 | 200            | 140200     |
|                                 | 225            | 140225     |
|                                 | 250            | 140250     |
|                                 | 280            | 140280     |




➔

|                    | Afmeting in mm | Artikelnr. |
|--------------------|----------------|------------|
| <b>Vervolg 140</b> | 315            | 140315     |
|                    | 355            | 140355     |
|                    | 400            | 140400     |
|                    | 450            | 140450     |
|                    | 500            | 140500     |

Artikelgroep: 01.02.42

|                                 | Afmeting in mm  | Artikelnr. |
|---------------------------------|-----------------|------------|
| <b>144</b>                      | 63 x 32 x 63    | 144063032  |
| <b>PE Verloop T-stuk 90°</b>    | 63 x 50 x 63    | 144063050  |
|                                 | 75 x 32 x 75    | 144075032  |
| - lange spie-einden             | 75 x 50 x 75    | 144075050  |
| - voor elektrolas en spiegellas | 75 x 63 x 75    | 144075063  |
| - PE 100                        | 90 x 50 x 90    | 144090050  |
| - SDR11                         | 90 x 63 x 90    | 144090063  |
|                                 | 90 x 75 x 90    | 144090075  |
|                                 | 110 x 63 x 110  | 144110063  |
|                                 | 110 x 75 x 110  | 144110075  |
|                                 | 110 x 90 x 110  | 144110090  |
|                                 | 125 x 63 x 125  | 144125063  |
|                                 | 125 x 75 x 125  | 144125075  |
|                                 | 125 x 90 x 125  | 144125090  |
|                                 | 125 x 110 x 125 | 144125110  |
|                                 | 140 x 63 x 140  | 144140063  |
|                                 | 140 x 75 x 140  | 144140075  |
|                                 | 140 x 90 x 140  | 144140090  |
|                                 | 140 x 110 x 140 | 144140110  |
|                                 | 160 x 63 x 160  | 144160063  |
|                                 | 160 x 75 x 160  | 144160075  |
|                                 | 160 x 90 x 160  | 144160090  |
|                                 | 160 x 110 x 160 | 144160110  |
|                                 | 180 x 75 x 180  | 144180075  |
|                                 | 180 x 90 x 180  | 144180090  |
|                                 | 180 x 110 x 180 | 144180110  |
|                                 | 180 x 125 x 180 | 144180125  |
|                                 | 180 x 140 x 180 | 144180140  |
|                                 | 180 x 160 x 180 | 144180160  |
|                                 | 200 x 63 x 200  | 144200063  |
|                                 | 200 x 75 x 200  | 144200075  |
|                                 | 200 x 90 x 200  | 144200090  |
|                                 | 200 x 110 x 200 | 144200110  |
|                                 | 200 x 125 x 200 | 144200125  |
|                                 | 200 x 160 x 200 | 144200160  |
|                                 | 225 x 63 x 225  | 144225063  |
|                                 | 225 x 75 x 225  | 144225075  |
|                                 | 225 x 90 x 225  | 144225090  |
|                                 | 225 x 110 x 225 | 144225110  |
|                                 | 225 x 125 x 225 | 144225125  |
|                                 | 225 x 140 x 225 | 144225140  |
|                                 | 225 x 160 x 225 | 144225160  |
|                                 | 250 x 90 x 250  | 144250090  |
|                                 | 250 x 110 x 250 | 144250110  |
|                                 | 250 x 125 x 250 | 144250125  |
|                                 | 250 x 160 x 250 | 144250160  |
|                                 | 250 x 200 x 250 | 144250200  |
|                                 | 280 x 160 x 280 | 144280160  |
|                                 | 315 x 90 x 315  | 144315090  |
|                                 | 315 x 110 x 315 | 144315110  |
|                                 | 315 x 125 x 315 | 144315125  |
|                                 | 315 x 160 x 315 | 144315160  |
|                                 | 315 x 200 x 315 | 144315200  |
|                                 | 315 x 250 x 315 | 144315250  |
|                                 | 355 x 200 x 355 | 144355200  |
|                                 | 355 x 250 x 355 | 144355250  |
|                                 | 355 x 280 x 355 | 144355280  |
|                                 | 355 x 315 x 355 | 144355315  |
|                                 | 400 x 280 x 400 | 144400280  |
|                                 | 400 x 315 x 400 | 144400315  |
|                                 | 400 x 355 x 400 | 144400355  |
|                                 | 500 x 355 x 500 | 144500355  |
|                                 | 500 x 400 x 500 | 144500400  |
|                                 | 500 x 450 x 500 | 144500450  |



Artikelgroep: 01.02.45




# 01.02 Fittingen voor PE drukleidingen

## PE Drukfittingen SDR11 met lange spie-einden

01

|                                   | Afmeting in mm | Artikelnr. |
|-----------------------------------|----------------|------------|
| <b>138</b>                        | 40             | 138040     |
| <b>PE T-stuk 45° spuitgegoten</b> | 50             | 138050     |
|                                   | 63             | 138063     |
| - lange spie-einden               | 75             | 138075     |
| - voor elektrolas en spiegellas   | 90             | 138090     |
|                                   | 110            | 138110     |
| - PE 100                          | 125            | 138125     |
| - SDR11                           | 160            | 138160     |
|                                   | 200            | 138200     |
|                                   | 225            | 138225     |


Artikelgroep: 01.02.46



Grotere diameters zijn op aanvraag leverbaar.

|                                 | Afmeting in mm | Artikelnr. |
|---------------------------------|----------------|------------|
| <b>145*</b>                     | 20*            | 145020     |
| <b>PE 3-Delige koppeling</b>    | 25*            | 145025     |
|                                 | 32*            | 145032     |
| - lang model                    | 40*            | 145040     |
| - voor elektrolas en spiegellas | 50*            | 145050     |
| - PE 100                        | 63*            | 145063     |
| - SDR11                         |                |            |

Artikelgroep: 01.02.45



\* Verminderde drukbestendigheid max. PN8 water 20°C.

|                                 | Afmeting      | Artikelnr. |
|---------------------------------|---------------|------------|
| <b>255*</b>                     | 20 x 1/2" *   | 255020012  |
| <b>PE Schroefbus</b>            | 25 x 3/4" *   | 255025034  |
| - lang model                    | 32 x 1" *     | 255032100  |
| - binnendraad                   | 40 x 1 1/4" * | 255040114  |
| - voor elektrolas en spiegellas | 50 x 1 1/2" * | 255050112  |
| - PE 100                        | 63 x 2" *     | 255063200  |
| - SDR11                         |               |            |


Artikelgroep: 01.02.45



\* Verminderde drukbestendigheid max. PN8 water 20°C.

|                              | Afmeting      | Artikelnr.  |
|------------------------------|---------------|-------------|
| <b>39203*</b>                | 20 x 1/2" *   | 39203020012 |
| <b>PE Overgangskoppeling</b> | 25 x 3/4" *   | 39203025034 |
|                              | 32 x 1" *     | 39203032100 |
| - lang spie-eind             | 40 x 1 1/4" * | 39203040114 |
| - messing binnendraad        | 50 x 1 1/2" * | 39203050112 |
|                              | 63 x 2" *     | 39203063200 |
|                              | 75 x 2 1/2" * | 39203075212 |
|                              | 90 x 3" *     | 39203090300 |
|                              | 110 x 4" *    | 39203110400 |

Artikelgroep: 01.02.25



\* Verminderde drukbestendigheid max. PN8 water 20°C.

|                    | Afmeting    | Artikelnr.  |
|--------------------|-------------|-------------|
| <b>49717</b>       | 20 x 1/2"   | 49717020012 |
| <b>PE Puntstuk</b> | 25 x 3/4"   | 49717025034 |
| - lang spie-eind   | 32 x 1"     | 49717032100 |
| - buitendraad      | 40 x 1"     | 49717040100 |
| - PE 100           | 40 x 1 1/4" | 49717040114 |
| - SDR11            | 40 x 1 1/2" | 49717040112 |
|                    | 50 x 1 1/2" | 49717050112 |
|                    | 63 x 1 1/2" | 49717063112 |
|                    | 63 x 2"     | 49717063200 |

Artikelgroep: 01.02.25



|                              | Afmeting      | Artikelnr.  |
|------------------------------|---------------|-------------|
| <b>39703*</b>                | 20 x 1/2" *   | 39703020012 |
| <b>PE Overgangskoppeling</b> | 25 x 3/4" *   | 39703025034 |
|                              | 32 x 1" *     | 39703032100 |
| - lang spie-eind             | 40 x 1 1/4" * | 39703040114 |
| - messing buitendraad        | 50 x 1 1/2" * | 39703050112 |
|                              | 63 x 2" *     | 39703063200 |
|                              | 75 x 2 1/2" * | 39703075212 |
|                              | 90 x 3" *     | 39703090300 |
|                              | 110 x 4" *    | 39703110400 |

Artikelgroep: 01.02.25




\* Verminderde drukbestendigheid max. PN8 water 20°C.

## PE Drukfittingen SDR11 kort model

|                       | Afmeting in mm | Artikelnr.  |
|-----------------------|----------------|-------------|
| <b>175</b>            | 25 x 20        | 175025020   |
| <b>PE Verloopstuk</b> | 32 x 20        | 175032020   |
| - kort model          | 32 x 25        | 175032025   |
| - centrisch           | 40 x 20        | 175040020   |
| - voor spiegellas     | 40 x 25        | 175040025   |
| - PE 100              | 40 x 32        | 175040032   |
| - SDR11               | 50 x 25        | 175050025   |
|                       | 50 x 32        | 175050032   |
|                       | 50 x 40        | 175050040   |
|                       | 63 x 32        | 175063032   |
|                       | 63 x 40        | 175063040   |
|                       | 63 x 50        | 175063050   |
|                       | 75 x 40        | 175075040   |
|                       | 75 x 50        | 175075050   |
|                       | 75 x 63        | 175075063   |
|                       | 90 x 50        | 175090050   |
|                       | 90 x 63        | 175090063   |
|                       | 90 x 75        | 175090075   |
|                       | 110 x 50       | 175110050   |
|                       | 110 x 63       | 175110063   |
|                       | 110 x 75       | 175110075   |
|                       | 110 x 90       | 175110090   |
|                       | 125 x 63       | 175125063   |
|                       | 125 x 75       | 175125075   |
|                       | 125 x 90       | 175125090   |
|                       | 125 x 110      | 175125110   |
|                       | 140 x 75       | 175140075   |
|                       | 140 x 90       | 175140090 ↗ |





## PE Drukfittingen SDR11 kort model

|   | Afmeting in mm | Artikelnr.             |
|---|----------------|------------------------|
| <b>Vervolg 175</b><br> | 140 x 110      | 175140110              |
|   | 140 x 125      | 175140125              |
|   | 160 x 90       | 175160090              |
|   | 160 x 110      | 175160110              |
|   | 160 x 125      | 175160125              |
|   | 160 x 140      | 175160140              |
|   | 180 x 90       | 175180090              |
|   | 180 x 110      | 175180110              |
|   | 180 x 125      | 175180125              |
|   | 180 x 140      | 175180140              |
|   | 180 x 160      | 175180160              |
|   | 200 x 125      | 175200125              |
|   | 200 x 140      | 175200140              |
|   | 200 x 160      | 175200160              |
|   | 200 x 180      | 175200180              |
|   | 225 x 110      | 175225110              |
|   | 225 x 140      | 175225140              |
|   | 225 x 160      | 175225160              |
|   | 225 x 180      | 175225180              |
|   | 225 x 200      | 175225200              |
|   | 250 x 160      | 175250160              |
|   | 250 x 180      | 175250180              |
|   | 250 x 200      | 175250200              |
|   | 250 x 225      | 175250225              |
|   | 280 x 180      | 175280180              |
|   | 280 x 200      | 175280200              |
|   | 280 x 225      | 175280225              |
|   | 280 x 250      | 175280250              |
|   | 315 x 200      | 175315200              |
|   | 315 x 225      | 175315225              |
|   | 315 x 250      | 175315250              |
|   | 315 x 280      | 175315280              |
|   | 355 x 225      | 175355225              |
|   | 355 x 250      | 175355250              |
|   | 355 x 280      | 175355280              |
|   | 355 x 315      | 175355315              |
|   | 400 x 280      | 175400280              |
|   | 400 x 315      | 175400315              |
|   | 400 x 355      | 175400355              |
|   | 450 x 315      | 175450315              |
|   | 450 x 355      | 175450355              |
|   | 450 x 400      | 175450400              |
|   | 500 x 315      | 175500315              |
|   | 500 x 355      | 175500355              |
|   | 500 x 400      | 175500400              |
| 500 x 450   | 175500450      |                        |
| 560 x 400   | 175560400      |                        |
| 560 x 450   | 175560450      |                        |
| 560 x 500   | 175560500      |                        |
| 630 x 450   | 175630450      |                        |
| 630 x 500   | 175630500      |                        |
| 630 x 560   | 175630560      |                        |
|   |                | Artikelgroep: 01.02.45 |

|   | Afmeting in mm | Artikelnr. |
|---|----------------|------------|
| <b>185</b><br><b>PE Voorlaskraag</b><br>- kort model<br>- voor spiegellas<br>- PE 100<br>- SDR11<br> | 25             | 185025     |
|   | 32             | 185032     |
|   | 40             | 185040     |
|   | 50             | 185050     |
|   | 63             | 185063     |
|   | 75             | 185075     |
|   | 90             | 185090     |
|   | 110            | 185110     |
|   | 125            | 185125     |
|   | 140            | 185140     |
|   | 160            | 185160     |
|   | 180            | 185180     |
|   | 200            | 185200 ↗   |

|   | Afmeting in mm | Artikelnr. |                        |
|---|----------------|------------|------------------------|
| <b>Vervolg 185</b><br> | 225            | 185225     |                        |
|   | 250            | 185250     |                        |
|   | 280            | 185280     |                        |
|   | 315            | 185315     |                        |
|   | 355            | 185355     |                        |
|   | 400            | 185400     |                        |
|   | 450            | 185450     |                        |
|   | 500            | 185500     |                        |
|   | 560            | 185560     |                        |
|   | 630            | 185630     |                        |
|   | 710            | 185710     |                        |
|   | 800            | 185800     |                        |
|   | 900            | 185900     |                        |
|   |                |            | Artikelgroep: 01.02.45 |

|  | Afmeting in mm | Artikelnr.             |
|--|----------------|------------------------|
| <b>125</b><br><b>PE Bocht 90°</b><br>- r=d<br>- voor spiegellas<br>- PE 100<br>- SDR11<br> | 20             | 125020                 |
|  | 25             | 125025                 |
|  | 32             | 125032                 |
|  | 40             | 125040                 |
|  | 50             | 125050                 |
|  | 63             | 125063                 |
|  | 75             | 125075                 |
|  | 90             | 125090                 |
|  | 110            | 125110                 |
|  | 125            | 125125                 |
|  | 140            | 125140                 |
|  | 160            | 125160                 |
|  | 180            | 125180                 |
|  | 200            | 125200                 |
|  | 225            | 125225                 |
|  | 250            | 125250                 |
| 280  | 125280         |                        |
| 315  | 125315         |                        |
| 355  | 125355         |                        |
| 400  | 125400         |                        |
|  |                | Artikelgroep: 01.02.45 |

|   | Afmeting in mm | Artikelnr.             |
|---|----------------|------------------------|
| <b>170</b><br><b>PE T-stuk 90°</b><br>- kort model<br>- voor spiegellas<br>- PE 100<br>- SDR11<br> | 20             | 170020                 |
|   | 25             | 170025                 |
|   | 32             | 170032                 |
|   | 40             | 170040                 |
|   | 50             | 170050                 |
|   | 63             | 170063                 |
|   | 75             | 170075                 |
|   | 90             | 170090                 |
|   | 110            | 170110                 |
|   | 125            | 170125                 |
|   | 140            | 170140                 |
|   | 160            | 170160                 |
|   | 180            | 170180                 |
|   | 200            | 170200                 |
|   | 225            | 170225                 |
|   | 250            | 170250                 |
|   | 280            | 170280                 |
| 315   | 170315         |                        |
| 355   | 170355         |                        |
| 400   | 170400         |                        |
| 450   | 170450         |                        |
| 500   | 170500         |                        |
|   |                | Artikelgroep: 01.02.45 |

# 01.02 Fittingen voor PE drukleidingen

## PE Drukfittingen SDR11 r=1,5d

01

|                                  | Afmeting in mm | Artikelnr. |
|----------------------------------|----------------|------------|
| <b>135</b>                       | 32             | 135032     |
| <b>PE Bocht 90°</b>              | 40             | 135040     |
| - r=1,5d                         | 50             | 135050     |
| - lange spie-einden              | 63             | 135063     |
| - naadloos uit buis getrokken    | 75             | 135075     |
|                                  | 90             | 135090     |
| - voor elektrolas en spiegelllas | 110            | 135110     |
|                                  | 125            | 135125     |
| - PE 100                         | 140            | 135140     |
| - SDR11                          | 160            | 135160     |
|                                  | 180            | 135180     |
|                                  | 200            | 135200     |
|                                  | 225            | 135225     |
|                                  | 250            | 135250     |
|                                  | 280            | 135280     |
|                                  | 315            | 135315     |
|                                  | 355            | 135355     |
|                                  | 400            | 135400     |
|                                  | 450            | 135450     |
|                                  | 500            | 135500     |
|                                  | 560            | 135560     |
|                                  | 630            | 135630     |
|                                  | 710            | 135710     |
|                                  | 800            | 135800     |
|                                  | 900            | 135900     |

Artikelgroep: 01.02.47



|                                  | Afmeting in mm | Artikelnr. |
|----------------------------------|----------------|------------|
| <b>165</b>                       | 32             | 165032     |
| <b>PE Bocht 45°</b>              | 40             | 165040     |
| - r=1,5d                         | 50             | 165050     |
| - lange spie-einden              | 63             | 165063     |
| - naadloos uit buis getrokken    | 75             | 165075     |
|                                  | 90             | 165090     |
| - voor elektrolas en spiegelllas | 110            | 165110     |
|                                  | 125            | 165125     |
| - PE 100                         | 140            | 165140     |
| - SDR11                          | 160            | 165160     |
|                                  | 180            | 165180     |
|                                  | 200            | 165200     |
|                                  | 225            | 165225     |
|                                  | 250            | 165250     |
|                                  | 280            | 165280     |
|                                  | 315            | 165315     |
|                                  | 355            | 165355     |
|                                  | 400            | 165400     |
|                                  | 450            | 165450     |
|                                  | 500            | 165500     |
|                                  | 560            | 165560     |
|                                  | 630            | 165630     |
|                                  | 710            | 165710     |
|                                  | 800            | 165800     |
|                                  | 900            | 165900     |

Artikelgroep: 01.02.47



|                                  | Afmeting in mm | Artikelnr. |
|----------------------------------|----------------|------------|
| <b>167*</b>                      | 32             | 167032     |
| <b>PE Bocht 30°</b>              | 40             | 167040     |
| - r=1,5d                         | 50             | 167050     |
| - lange spie-einden              | 63             | 167063     |
| - naadloos uit buis getrokken    | 75             | 167075     |
|                                  | 90             | 167090     |
| - voor elektrolas en spiegelllas | 110            | 167110     |
|                                  | 125            | 167125     |
| - PE 100                         | 140            | 167140     |
| - SDR11                          | 160            | 167160     |
|                                  | 180            | 167180     |
|                                  | 200            | 167200     |
|                                  | 225            | 167225     |
|                                  | 250            | 167250     |

Artikelgroep: 01.02.47



|                     | Afmeting in mm | Artikelnr. |
|---------------------|----------------|------------|
| <b>Vervolg 167*</b> | 280            | 167280     |
|                     | 315            | 167315     |
|                     | 355            | 167355     |
|                     | 400            | 167400     |
|                     | 450            | 167450     |
|                     | 500            | 167500     |
|                     | 560            | 167560     |
|                     | 630            | 167630     |
|                     | 710            | 167710     |
|                     | 800            | 167800     |
|                     | 900            | 167900     |

Artikelgroep: 01.02.47

\* Artikelnr. 163: PE Bocht 60° r=1,5d op aanvraag leverbaar.

|                                  | Afmeting in mm | Artikelnr. |
|----------------------------------|----------------|------------|
| <b>168</b>                       | 32             | 168032     |
| <b>PE Bocht 22°</b>              | 40             | 168040     |
| - r=1,5d                         | 50             | 168050     |
| - lange spie-einden              | 63             | 168063     |
| - naadloos uit buis getrokken    | 75             | 168075     |
|                                  | 90             | 168090     |
| - voor elektrolas en spiegelllas | 110            | 168110     |
|                                  | 125            | 168125     |
| - PE 100                         | 140            | 168140     |
| - SDR11                          | 160            | 168160     |
|                                  | 180            | 168180     |
|                                  | 200            | 168200     |
|                                  | 225            | 168225     |
|                                  | 250            | 168250     |
|                                  | 280            | 168280     |
|                                  | 315            | 168315     |
|                                  | 355            | 168355     |
|                                  | 400            | 168400     |
|                                  | 450            | 168450     |
|                                  | 500            | 168500     |
|                                  | 560            | 168560     |
|                                  | 630            | 168630     |
|                                  | 710            | 168710     |
|                                  | 800            | 168800     |
|                                  | 900            | 168900     |

Artikelgroep: 01.02.47



|                                  | Afmeting in mm | Artikelnr. |
|----------------------------------|----------------|------------|
| <b>169</b>                       | 32             | 169032     |
| <b>PE Bocht 11°</b>              | 40             | 169040     |
| - r=1,5d                         | 50             | 169050     |
| - lange spie-einden              | 63             | 169063     |
| - naadloos uit buis getrokken    | 75             | 169075     |
|                                  | 90             | 169090     |
| - voor elektrolas en spiegelllas | 110            | 169110     |
|                                  | 125            | 169125     |
| - PE 100                         | 140            | 169140     |
| - SDR11                          | 160            | 169160     |
|                                  | 180            | 169180     |
|                                  | 200            | 169200     |
|                                  | 225            | 169225     |
|                                  | 250            | 169250     |
|                                  | 280            | 169280     |
|                                  | 315            | 169315     |
|                                  | 355            | 169355     |
|                                  | 400            | 169400     |
|                                  | 450            | 169450     |
|                                  | 500            | 169500     |
|                                  | 560            | 169560     |
|                                  | 630            | 169630     |
|                                  | 710            | 169710     |
|                                  | 800            | 169800     |
|                                  | 900            | 169900     |

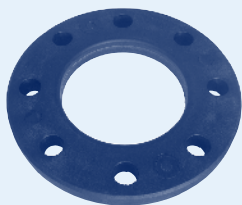
Artikelgroep: 01.02.47



## PP Flenzen voor PE leidingen

Voor afwijkende uitvoeringen of diameters kunt u contact opnemen met onze verkoopmedewerkers.

|                           | Afmeting<br>in mm/DN | Geboord/drukklass<br>PN | øk<br>in mm | ød6<br>in mm | b<br>in mm | n x ød2<br>in mm | Artikelnr. |
|---------------------------|----------------------|-------------------------|-------------|--------------|------------|------------------|------------|
| <b>5903</b>               | 20/15                | 10/16                   | 65          | 28           | 12         | 4 x 14           | 5903020    |
| <b>PP Overschuifflens</b> | 25/20                | 10/16                   | 75          | 34           | 14         | 4 x 14           | 5903025    |
| - met stalen kern         | 32/25                | 10/16                   | 85          | 42           | 14         | 4 x 14           | 5903032    |
| - voor PE/PP kraagbussen  | 40/32                | 10/16                   | 100         | 51           | 16         | 4 x 18           | 5903040    |
| - volgens DIN2501         | 50/40                | 10/16                   | 110         | 62           | 18         | 4 x 18           | 5903050    |
|                           | 63/50                | 10/16                   | 125         | 78           | 18         | 4 x 18           | 5903063    |
|                           | 75/65                | 10/16                   | 145         | 92           | 18         | 4 x 18           | 5903075    |
|                           | 90/80                | 10/16                   | 160         | 108          | 18         | 8 x 18           | 5903090    |
|                           | 110/100              | 10/16                   | 180         | 128          | 18         | 8 x 18           | 5903110    |
|                           | 125/100              | 10/16                   | 180         | 135          | 18         | 8 x 18           | 5903125    |
|                           | 140/125              | 10/16                   | 210         | 158          | 24         | 8 x 18           | 5903140    |
|                           | 160/150              | 10/16                   | 240         | 178          | 24         | 8 x 22           | 5903160    |
|                           | 180/150              | 10/16                   | 240         | 188          | 24         | 8 x 22           | 5903180    |
|                           | 200/200              | 10                      | 295         | 235          | 24         | 8 x 22           | 5903200    |
|                           | 200/200              | 16                      | 295         | 235          | 24         | 12 x 22          | 590320016  |
|                           | 225/200              | 10                      | 295         | 238          | 24         | 8 x 22           | 5903225    |
|                           | 225/200              | 16                      | 295         | 238          | 24         | 12 x 22          | 590322516  |
|                           | 250/250              | 10                      | 350         | 288          | 31         | 12 x 22          | 5903250    |
|                           | 250/250              | 16                      | 355         | 288          | 30         | 12 x 26          | 590325016  |
|                           | 280/250              | 10                      | 350         | 294          | 34         | 12 x 22          | 5903280    |
|                           | 280/250              | 16                      | 355         | 294          | 30         | 12 x 26          | 590328016  |
|                           | 315/300              | 10                      | 400         | 338          | 34         | 12 x 22          | 5903315    |
|                           | 315/300              | 16                      | 410         | 338          | 34         | 12 x 26          | 590331516  |
|                           | 355/350              | 10                      | 460         | 376          | 39         | 16 x 22          | 5903355    |
|                           | 355/350              | 16                      | 470         | 376          | 42         | 16 x 26          | 590335516  |
|                           | 400/400              | 10                      | 515         | 430          | 43         | 16 x 26          | 5903400    |
|                           | 400/400              | 16                      | 525         | 430          | 46         | 16 x 30          | 590340016  |
|                           | 450/500              | 10                      | 620         | 517          | 54         | 20 x 26          | 5903450    |
|                           | 500/500              | 10                      | 620         | 533          | 54         | 20 x 26          | 5903500    |
|                           | 560/600              | 10                      | 725         | 618          | 64         | 20 x 30          | 5903560    |
|                           | 630/600              | 10                      | 725         | 645          | 58         | 20 x 30          | 5903630    |



Artikelgr.: 01.02.50

øk = steekcirkel  
ød6 = binnenmaat  
b = dikte flens  
n = aantal gaten  
ød2 = diameter gat

# 01.02 Fittingen voor PE drukleidingen

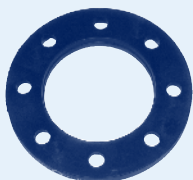
## PP Flenzen voor PE leidingen

01

### 5907

#### PP Overschuifflens ANSI

- met stalen kern
- voor PE/PP kraagbussen
- volgens B16.5



| Afmeting    | Geboord/drukklass<br>lbs /PN | øk<br>in mm | b<br>in mm | n x ød2<br>in mm | Artikelnr. |
|-------------|------------------------------|-------------|------------|------------------|------------|
| 20 (1/2")   | 150/10                       | 60,3        | 12         | 4 x 15,9         | 5907020    |
| 25 (3/4")   | 150/10                       | 69,8        | 12         | 4 x 15,9         | 5907025    |
| 32 (1")     | 150/10                       | 79,4        | 16         | 4 x 15,9         | 5907032    |
| 40 (1 1/4") | 150/10                       | 88,9        | 16         | 4 x 15,9         | 5907040    |
| 50 (1 1/2") | 150/10                       | 98,4        | 18         | 4 x 15,9         | 5907050    |
| 63 (2")     | 150/10                       | 120,6       | 18         | 4 x 20           | 5907063    |
| 75 (2 1/2") | 150/10                       | 139,7       | 18         | 4 x 19           | 5907075    |
| 90 (3")     | 150/10                       | 152,4       | 18         | 4 x 19           | 5907090    |
| 110 (4")    | 150/10                       | 190,5       | 18         | 4 x 19           | 5907110    |
| 160 (6")    | 150/10                       | 240,0       | 24         | 8 x 22           | 5907160    |
| 200 (8")    | 150/10                       | 295,0       | 24         | 8 x 22           | 5907200    |
| 250 (10")   | 150/10                       | 362,0       | 30         | 8 x 25           | 5907250    |
| 315 (12")   | 150/10                       | 431,8       | 34         | 12 x 25,4        | 5907315    |
| 355 (14")   | 150/10                       | 476,2       | 42         | 12 x 28,6        | 5907355    |
| 400 (16")   | 150/10                       | 539,7       | 44         | 12 x 28,6        | 5907400    |

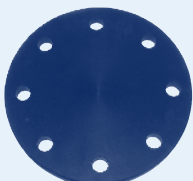
Artikelgr.: 01.02.50

- øk = steekcirkel
- b = dikte flens
- n = aantal gaten
- ød2 = diameter gat

### 5902

#### PP Blindflens

- met stalen kern
- voor PE/PP kraagbussen
- volgens DIN2501



| Afmeting<br>in mm | Geboord/drukklass<br>PN | øk<br>in mm | b<br>in mm | n x ød2<br>in mm | Artikelnr. |
|-------------------|-------------------------|-------------|------------|------------------|------------|
| 20                | 10/16                   | 65          | 12         | 4 x 14           | 5902020    |
| 25                | 10/16                   | 75          | 12         | 4 x 14           | 5902025    |
| 32                | 10/16                   | 85          | 16         | 4 x 14           | 5902032    |
| 40                | 10/16                   | 100         | 18         | 4 x 18           | 5902040    |
| 50                | 10/16                   | 110         | 18         | 4 x 18           | 5902050    |
| 63                | 10/16                   | 125         | 18         | 4 x 18           | 5902063    |
| 75                | 10/16                   | 145         | 18         | 4 x 18           | 5902075    |
| 90                | 10/16                   | 160         | 20         | 8 x 18           | 5902090    |
| 110/125           | 10/16                   | 180         | 20         | 8 x 18           | 5902110    |
| 140               | 10/16                   | 210         | 24         | 8 x 18           | 5902140    |
| 160/180           | 10/16                   | 240         | 24         | 8 x 22           | 5902160    |
| 200/225           | 10                      | 295         | 24         | 8 x 22           | 5902200    |
| 250               | 10                      | 350         | 30         | 12 x 22          | 5902250    |
| 280               | 10                      | 350         | 30         | 12 x 22          | 5902280    |
| 315               | 10                      | 400         | 34         | 12 x 22          | 5902315    |
| 355               | 10                      | 460         | 39         | 16 x 22          | 5902355    |
| 400               | 10                      | 515         | 44         | 16 x 26          | 5902400    |

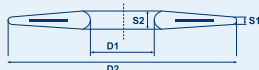
Artikelgr.: 01.02.50

- øk = steekcirkel
- b = dikte flens
- n = aantal gaten
- ød2 = diameter gat

## PSI Pakkingen, afdichtingen en Petro-band

01

**Fig. 192**  
EPDM Pakking  
met staalinlage  
- voor water



| Afmeting | Drukklasse | D1xD2 / S1xS2<br>in mm | Geschikt voor                     | Artikelnr. |
|----------|------------|------------------------|-----------------------------------|------------|
| DN15     | PN10/40    | 22 x 51 / 3-4          | 20mm PE/PVC/staal                 | 100802462  |
| DN20     | PN10/40    | 27 x 61 / 3-4          | 25mm PE/PVC/staal                 | 100803463  |
| DN25     | PN10/40    | 34 x 71 / 3-4          | 32mm PE/PVC/staal                 | 100801464  |
| DN32     | PN10/40    | 43 x 82 / 3-4          | 40mm PE/PVC/staal                 | 100803418  |
| DN40     | PN10/40    | 49 x 92 / 3-4          | 50mm PE/PVC/staal                 | 100803439  |
| DN50     | PN10/40    | 61 x 107 / 4-5         | 63mm PE/PVC/staal                 | 100803462  |
| DN65     | PN10/40    | 77 x 127 / 4-5         | 75mm PE/PVC/staal                 | 100803483  |
| DN80     | PN10/40    | 89 x 142 / 3-4         | 90mm PE/PVC/staal                 | 100801465  |
| DN100    | PN10/16    | 115 x 162 / 4-5        | 110mm PE/PVC/staal                | 100801466  |
| DN100    | PN25/40    | 115 x 168 / 5-6        | 125mm PE/staal                    | 100801488  |
| DN125    | PN10/16    | 141 x 192 / 4-5        | 140mm PE/PVC/staal                | 100803491  |
| DN150    | PN10/16    | 169 x 218 / 4-5        | 160mm PE/PVC/staal-180mm PE/Staal | 100803495  |
| DN200    | PN10/16    | 220 x 273 / 5-6        | 200mm / 225mm PE/PVC/staal        | 100803499  |
| DN250    | PN10       | 273 x 328 / 5-6        | 250mm / 280mm PE/PVC/staal        | 100803504  |
| DN250    | PN16       | 273 x 329 / 6-7        | 250mm / 280mm PE/PVC/staal        | 100803505  |
| DN300    | PN10       | 324 x 378 / 5-6        | 315mm PE/PVC/staal                | 100803510  |
| DN300    | PN16       | 324 x 384 / 6-7        | 315mm PE/staal                    | 100803511  |
| DN350    | PN10       | 356 x 438 / 6-7        | 355mm PVC                         | 100803515  |
| DN350    | PN16       | 368 x 445 / 7-9        | 355mm PE/staal                    | 100801516  |
| DN400    | PN10       | 407 x 489 / 6-7        | 400mm PE/PVC/staal                | 100903520  |
| DN400    | PN16       | 407 x 495 / 7-9        | 400mm PE/staal                    | 100903521  |
| DN450    | PN10       | 470 x 540 / 7-9        | 450mm PE/staal                    | 100903525  |
| DN450    | PN16       | 470 x 557 / 7-9        | 450mm PE/staal                    | 100901526  |
| DN500    | PN10       | 508 x 594 / 6-7        | 450mm / 500mm PE/staal            | 100901474  |
| DN500    | PN16       | 508 x 617 / 7-9        | 450mm / 500mm PE/staal            | 100903532  |
| DN600    | PN10       | 610 x 695 / 6-7        | 630mm PE/staal                    | 100901475  |
| DN700    | PN10       | 712 x 810 / 7-8        | 710mm PE/staal                    | 100901476  |
| DN800    | PN10       | 813 x 917 / 7-8        | 800mm PE/staal                    | 100901477  |
| DN900    | PN10       | 915 x 1017/7-8         | 900mm PE                          | 100901548  |
| DN1000   | PN10       | 1016 x 1124/7-8        | 1000mm PE                         | 100901479  |

Artikelgroep: 16.02.05

PN6 flenzen zijn op aanvraag leverbaar.

**Fig. 195**  
EPDM Pakking  
- verstelbaar tot 8°



| DN  | Drukklasse | Dikte in mm<br>(min x max) | Maat bout x<br>lengte in mm | Artikelnr. |
|-----|------------|----------------------------|-----------------------------|------------|
| 32  | PN10/40    | 9 x 20                     | M14 x 90                    | 100804001  |
| 40  | PN10/40    | 9 x 22                     | M14 x 90                    | 100804002  |
| 50  | PN10/40    | 9 x 24                     | M14 x 100                   | 100804003  |
| 65  | PN10/40    | 9 x 26                     | M14 x 100                   | 100804004  |
| 80  | PN10/40    | 14 x 30                    | M14 x 100                   | 100804005  |
| 100 | PN10/16    | 14 x 30                    | M14 x 100                   | 100804006  |
| 100 | PN25/40    | 14 x 33                    | M18 x 110                   | 100804007  |
| 125 | PN10/16    | 14 x 36                    | M14 x 100                   | 100804110  |
| 150 | PN10/16    | 14 x 39                    | M18 x 110                   | 100804008  |
| 150 | PN25/40    | 14 x 39                    | M22 x 130                   | 100804009  |
| 200 | PN10/16    | 15 x 50                    | M18 x 120                   | 100804010  |
| 200 | PN40       | 15 x 50                    | M24 x 160                   | 100804011  |
| 250 | PN10/16    | 16 x 59                    | M18 x 140                   | 100804012  |
| 250 | PN40       | 16 x 59                    | M27 x 170                   | 100804013  |
| 300 | PN10       | 22 x 68                    | M18 x 150                   | 100804014  |
| 350 | PN10       | 22 x 68                    | M18 x 150                   | 100804015  |
| 400 | PN10       | 22 x 74                    | M22 x 160                   | 100804016  |
| 500 | PN10       | 23 x 79                    | M22 x 180                   | 100804017  |

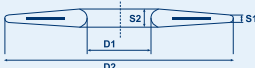
Artikelgroep: 16.02.05

# 01.02 Fittingen voor PE drukleidingen

## PSI Pakkingen, afdichtingen en Petro-band

01

**Fig. 205**  
NBR Pakking  
met staalinlage  
- voor water



| Afmeting | Drukklasse | D1xD2 / S1xS2<br>in mm | Geschikt voor                     | Artikelnr. |
|----------|------------|------------------------|-----------------------------------|------------|
| DN15     | PN10/40    | 22 x 51 / 3-4          | 20mm PE/PVC/staal                 | 100801287  |
| DN20     | PN10/40    | 27 x 61 / 3-4          | 25mm PE/PVC/staal                 | 100801288  |
| DN25     | PN10/40    | 34 x 71 / 3-4          | 32mm PE/PVC/staal                 | 100801289  |
| DN32     | PN10/40    | 43 x 82 / 3-4          | 40mm PE/PVC/staal                 | 100903242  |
| DN40     | PN10/40    | 49 x 92 / 3-4          | 50mm PE/PVC/staal                 | 100803263  |
| DN50     | PN10/40    | 61 x 107 / 4-5         | 63mm PE/PVC/staal                 | 100803286  |
| DN65     | PN10/40    | 77 x 127 / 4-5         | 75mm PE/PVC/staal                 | 100803308  |
| DN80     | PN10/40    | 89 x 142 / 3-4         | 90mm PE/PVC/staal                 | 100803309  |
| DN100    | PN10/16    | 115 x 162 / 4-5        | 110mm PE/PVC/staal                | 100803312  |
| DN100    | PN25/40    | 115 x 168 / 5-6        | 125mm PE                          | 100803313  |
| DN125    | PN10/16    | 141 x 192 / 4-5        | 140mm PE/PVC/staal                | 100803316  |
| DN150    | PN10/16    | 169 x 218 / 4-5        | 160mm PE/PVC/staal-180mm PE/staal | 100803320  |
| DN200    | PN10/16    | 220 x 273 / 5-6        | 200mm / 225mm PE/PVC/staal        | 100803324  |
| DN250    | PN10       | 273 x 328 / 5-6        | 250mm / 280mm PE/PVC/staal        | 100803329  |
| DN250    | PN16       | 273 x 329 / 6-7        | 250mm / 280mm PE/PVC/staal        | 100803330  |
| DN300    | PN10       | 324 x 378 / 5-6        | 315mm PE/PVC/staal                | 100803335  |
| DN300    | PN16       | 324 x 384 / 6-7        | 315mm PE/staal                    | 100803336  |
| DN350    | PN10       | 356 x 438 / 6-7        | 355mm PVC                         | 100801297  |
| DN350    | PN16       | 368 x 445 / 7-9        | 355mm PE                          | 100801341  |
| DN400    | PN10       | 407 x 489 / 6-7        | 400mm PE/PVC/staal                | 100903345  |
| DN400    | PN16       | 407 x 495 / 7-9        | 400mm PE/staal                    | 100903346  |
| DN450    | PN10       | 470 x 540 / 7-9        | 450mm PE                          | 100903350  |
| DN450    | PN16       | 470 x 557 / 7-9        | 450mm PE                          | 100901351  |
| DN500    | PN10       | 508 x 594 / 6-7        | 450mm / 500mm PE/staal            | 100903356  |
| DN500    | PN16       | 508 x 617 / 7-9        | 450mm / 500mm PE/staal            | 100903358  |
| DN600    | PN10       | 610 x 695 / 6-7        | 630mm PE/staal                    | 100903362  |
| DN700    | PN10       | 712 x 810 / 7-8        | 710mm PE/staal                    | 100903366  |
| DN800    | PN10       | 813 x 917 / 7-8        | 800mm PE                          | 100901302  |
| DN900    | PN10       | 915 x 1017 / 7-8       | 900mm PE                          | 100901374  |
| DN1000   | PN10       | 1016 x 1124 / 7-8      | 1000mm PE                         | 100901304  |

Artikelgroep: 16.02.05

| Type   | Bereik in mm | Artikelnr. EPDM | Artikelnr. NBR |
|--|--------------|-----------------|----------------|
| <b>Fig. 220</b><br><b>Link-Seal afsluitschakel</b> |              |                 |                |
| - alle metalen delen                               |              |                 |                |
| RVS316   |              |                 |                |
| - EPDM rubber (zwart)*                             |              |                 |                |
| (standaard)  |              |                 |                |
| - NBR rubber (groen)                               |              |                 |                |
| LS-200-S-316                                       | 12,7 - 15,7  | 202500139       | 202500156      |
| LS-265-S-316                                       | 16 - 20      | 202500186       | -              |
| LS-275-S-316                                       | 16 - 20      | 202500140       | 202500150      |
| LS-300-S-316                                       | 18 - 22,5    | 202500141       | 202500151      |
| LS-310-S-316                                       | 18 - 22,5    | 202500187       | -              |
| LS-315-S-316                                       | 21,1 - 26    | 202500146       | 202500157      |
| LS-325-S-316                                       | 23,2 - 30    | 202500142       | 202500152      |
| LS-340-S-316                                       | 25,5 - 34    | 202500143       | 202500055      |
| LS-360-S-316                                       | 32 - 42      | 202500144       | 202500056      |
| LS-400-S-316                                       | 36,3 - 46    | 202500172       | 202500153      |
| LS-410-S-316                                       | 37 - 48,5    | 202500173       | 202500161      |
| LS-425-S-316                                       | 28,4 - 37    | 202500174       | 202500154      |
| LS-440-S-316                                       | 44 - 55      | 202500176       | 202500258      |
| LS-475-S-316                                       | 41,3 - 48,5  | 202500145       | 202500155      |
| LS-500-S-316                                       | 60,3 - 71,5  | 202500147       | 202500158      |
| LS-525-S-316                                       | 55,4 - 63,5  | 202500148       | 202500159      |
| LS-575-S-316                                       | 48 - 58      | 202500149       | 202500160      |
| LS-615-S-316                                       | 81,6 - 98    | 202500185       | 202500265      |
| LS-650-S-316                                       | 69 - 84      | 202500177       | 202500259      |

Artikelgroep: 16.02.05

\* EPDM rubber (blauw) op aanvraag leverbaar.

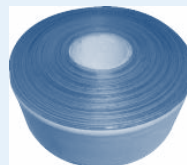
## PSI Pakkingen, afdichtingen en Petro-band

|                            | Afmeting in mm | Artikelnr. |
|----------------------------|----------------|------------|
| <b>Fig. 210</b>            | 32             | 101100004  |
| <b>Rubber instortflens</b> | 40             | 101100005  |
| <b>(muurdoorvoer)</b>      | 50             | 101100006  |
|                            | 63             | 101100007  |
|                            | 75             | 101100008  |
|                            | 90             | 101100009  |
|                            | 110            | 101100010  |
|                            | 125            | 101100011  |
|                            | 140            | 101100012  |
|                            | 160            | 101100013  |
|                            | 180            | 101100014  |
|                            | 200            | 101100015  |
|                            | 225            | 101100016  |
|                            | 250            | 101100017  |
|                            | 280            | 101100018  |
|                            | 315            | 101100019  |
|                            | 400            | 101100020  |
|                            | 450            | 101100021  |
|                            | 500            | 101100022  |
|                            | 560            | 101100023  |
|                            | 630            | 101100024  |
|                            | 800            | 101100029  |

Artikelgroep: 16.02.05



|  | Breedte in mm | Lengte in meter | Artikelnr.             |
|--|---------------|-----------------|------------------------|
| <b>Fig. 231</b>                                      | 50            | 15              | 4002S20088             |
| <b>Band voor afstandhouders</b>                      |               |                 | Artikelgroep: 16.02.05 |
| - anti-slip band voor het gebruik met afstandhouders |               |                 |                        |



|  | Type                | Artikelnr. |
|--|---------------------|------------|
| <b>Fig. 230</b>                            | Type AZ/AC 1- 16    | 300200085  |
| <b>Afstandhouder</b>                       | Type AZ/AC 1- 25    | 300200086  |
| - voor het leggen van leidingen in buis    | Type AZ/AC 1- 36    | 300200087  |
| - maatbereik leidingdiameter: 98 t/m 385mm | Type AZ/AC 1- 55    | 300200088  |
| - modulair systeem                         | Type AZ/AC 1- 75    | 300200089  |
|  | Type AZ/AC 1- 90    | 300200083  |
|  | Type AZ/AC 1-110    | 300200097  |
|  | Type AZ/AC 2- 16    | 300200090  |
|  | Type AZ/AC 2- 25    | 300200091  |
|  | Type AZ/AC 2- 36    | 300200092  |
|  | Type AZ/AC 2- 55    | 300200093  |
|  | Type AZ/AC 2- 75    | 300200094  |
|  | Type AZ/AC 2- 90    | 300200095  |
|  | Type AZ/AC 2-110    | 300200096  |
|  | Type MA 1- 25       | 300200050  |
|  | Type MA 1- 36       | 300200051  |
|  | Type MA 1- 50       | 300200053  |
|  | Type MA 1- 65       | 300200064  |
|  | Type MA 1- 75       | 300200054  |
|  | Type MA 2- 25       | 300200055  |
|  | Type MA 2- 36       | 300200056  |
|  | Type MA 2- 50       | 300200057  |
|  | Type MA 2- 65       | 300200063  |
|  | Type MA 2- 75       | 300200058  |
|  | Type PA/PE 2- 36*   | 300101018  |
|  | Type PA/PE 2,5- 36* | 300101022  |
|  | Type PA/PE 4- 16*   | 300101028  |
|  | Type PA/PE 9- 55*   | 300101123  |

Artikelgroep: 16.02.05



|                        | Breedte in mm | Artikelnr.             |
|------------------------|---------------|------------------------|
| <b>Fig. 240</b>        | 50            | 403500003              |
| <b>Kebu Petro-band</b> | 100           | 403500004              |
| - rol à 10 meter       |               | Artikelgroep: 16.02.05 |



|                           | Breedte in mm | Artikelnr.             |
|---------------------------|---------------|------------------------|
| <b>Fig. 243</b>           | 50            | 403500026              |
| <b>Kebu Reparatieband</b> |               | Artikelgroep: 16.02.05 |
| - rol à 10 meter          |               |                        |



|                        | Inhoud in gram | Artikelnr.             |
|------------------------|----------------|------------------------|
| <b>Fig. 246</b>        | 500            | 403500046              |
| <b>Kebu Kneadmassa</b> |                | Artikelgroep: 16.02.05 |



|                                       | Inhoud in ml | Artikelnr.             |
|---------------------------------------|--------------|------------------------|
| <b>Fig. 247</b>                       | 310          | 401522820              |
| <b>Stopaq afdichtingspasta FN2100</b> |              | Artikelgroep: 16.02.05 |



\* 1 ring = 2 stuks

Neem voor de geschikte afstandhouder voor uw toepassing en het benodigde aantal, contact op met onze afdeling verkoop.



# 01.02 Fittingen voor PE drukleidingen

## Hawle steekfittingen

- Trekvast kunststof steekfittingen.
- Met Gastec QA merk (waar van toepassing).

01

|                                 | Afmeting in mm | Artikelnr. |
|---------------------------------|----------------|------------|
| <b>6325</b><br>Rechte koppeling | 20             | 6325020    |
|                                 | 25             | 6325025    |
|                                 | 32             | 6325032    |
|                                 | 40             | 6325040    |
|                                 | 50             | 6325050    |
|                                 | 63             | 6325063    |
| Artikelgroep: 01.02.60          |                |            |



|                         | Afmeting in mm | Artikelnr. |
|-------------------------|----------------|------------|
| <b>6425</b><br>Knie 90° | 20             | 6425020    |
|                         | 25             | 6425025    |
|                         | 32             | 6425032    |
|                         | 40             | 6425040    |
|                         | 50             | 6425050    |
|                         | 63             | 6425063    |
| Artikelgroep: 01.02.60  |                |            |




|                                 | Afmeting in mm | Artikelnr. |
|---------------------------------|----------------|------------|
| <b>6335</b><br>Verloopkoppeling | 25 x 20        | 6335025020 |
|                                 | 32 x 25        | 6335032025 |
|                                 | 40 x 25        | 6335040025 |
|                                 | 40 x 32        | 6335040032 |
|                                 | 50 x 32        | 6335050032 |
|                                 | 50 x 40        | 6335050040 |
|                                 | 63 x 40        | 6335063040 |
|                                 | 63 x 50        | 6335063050 |
| Artikelgroep: 01.02.60          |                |            |



|   | Afmeting    | Artikelnr. |
|---|-------------|------------|
| <b>6435</b><br>Overgangsknie 90°<br>- met binnendraad | 20 x 1/2"   | 6435020012 |
|   | 25 x 3/4"   | 6435025034 |
|   | 32 x 1"     | 6435032100 |
|   | 40 x 1 1/4" | 6435040114 |
|   | 50 x 1 1/2" | 6435050112 |
|   | 63 x 2"     | 6435063200 |
| Artikelgroep: 01.02.60                                |             |            |




|                        | Afmeting in mm | Artikelnr. |
|------------------------|----------------|------------|
| <b>6226</b><br>Eindkap | 20             | 6226020    |
|                        | 25             | 6226025    |
|                        | 32             | 6226032    |
|                        | 40             | 6226040    |
|                        | 50             | 6226050    |
|                        | 63             | 6226063    |
| Artikelgroep: 01.02.60 |                |            |



|                       | Afmeting in mm         | Artikelnr. |
|-----------------------|------------------------|------------|
| <b>6555</b><br>T-stuk | 25                     | 6555025    |
|                       | 32                     | 6555032    |
|                       | 40                     | 6555040    |
|                       | 50                     | 6555050    |
|                       | 63                     | 6555063    |
|                       | Artikelgroep: 01.02.60 |            |




|  | Afmeting               | Artikelnr. |
|--|------------------------|------------|
| <b>6225</b><br>Overgangskoppeling<br>- met binnendraad | 20 x 1/2"              | 6225020012 |
|  | 20 x 3/4"              | 6225020034 |
|  | 25 x 3/4"              | 6225025034 |
|  | 32 x 1"                | 6225032100 |
|  | 40 x 1 1/4"            | 6225040114 |
|  | 50 x 1 1/2"            | 6225050112 |
|  | 63 x 2"                | 6225063200 |
|  | Artikelgroep: 01.02.60 |            |




|   | Afmeting               | Artikelnr. |  |
|---|------------------------|------------|--|
| <b>6525</b><br>Overgangs<br>T-stuk 90°<br>- met binnendraad | 20 x 1/2"              | 6525020012 |  |
|   | 25 x 3/4"              | 6525025034 |  |
|   | 32 x 1"                | 6525032100 |  |
|   | 40 x 1 1/4"            | 6525040114 |  |
|   | 50 x 1 1/2"            | 6525050112 |  |
|   | 63 x 2"                | 6525063200 |  |
|   | Artikelgroep: 01.02.60 |            |  |



|  | Afmeting    | Artikelnr. |
|--|-------------|------------|
| <b>6125</b><br>Overgangskoppeling<br>- met buitendraad | 20 x 1/2"   | 6125020012 |
|  | 25 x 3/4"   | 6125025034 |
|  | 32 x 1"     | 6125032100 |
|  | 32 x 1 1/4" | 6125032114 |
|  | 40 x 1 1/4" | 6125040114 |
|  | 50 x 1 1/2" | 6125050112 |
|  | 63 x 2"     | 6125063200 |
| Artikelgroep: 01.02.60                                 |             |            |

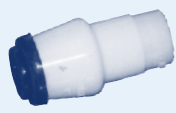


|   | Afmeting               | Artikelnr. |
|---|------------------------|------------|
| <b>6365</b><br>Overgangskoppeling<br>- naar KB - buis | 25 x 3/4"              | 6365025034 |
|   | 32 x 1"                | 6365032100 |
|   | 40 x 1"                | 6365040100 |
|   | 50 x 1 1/2"            | 6365050112 |
|   | Artikelgroep: 01.02.60 |            |



## Hawle steekfittingen

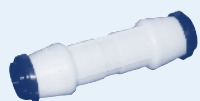
|   | Afmeting in mm | Artikelnr.             |
|---|----------------|------------------------|
| <b>6385</b><br><b>Overgangskoppeling</b><br>- naar koperen buis | 25 x 15        | 6385025015             |
|   | 25 x 22        | 6385025022             |
|   | 32 x 15        | 6385032015             |
|   | 32 x 22        | 6385032022             |
|   | 32 x 28        | 6385032028             |
|   | 40 x 28        | 6385040028             |
|   | 40 x 35        | 6385040035             |
|   | 50 x 42        | 6385050042             |
|   |                | Artikelgroep: 01.02.60 |



|  | Afmeting in mm | Artikelnr. |
|--|----------------|------------|
| <b>6931</b><br><b>Carborundumring</b><br>- voor PVC Buis | 20             | 6931020    |
|  | 25             | 6931025    |
|  | 32             | 6931032    |
|  | 40             | 6931040    |
|  | 50             | 6931050    |
|  | 63             | 6931063    |
|  |                |            |



|  | Afmeting in mm | Artikelnr.    |
|--|----------------|---------------|
| <b>6395</b><br><b>Overgangskoppeling</b><br>- kunststof mantelbuis | 32 x 22 x 32   | 6395032022032 |
|  | 40 x 28 x 40   | 6395040028040 |
|  |                |               |



|  | Afmeting in mm | Artikelnr.             |
|--|----------------|------------------------|
| <b>6710</b><br><b>Demontagewig</b><br>-set van 2 stuks | 20             | 6710020                |
|  | 25             | 6710025                |
|  | 32             | 6710032                |
|  | 40             | 6710040                |
|  | 50             | 6710050                |
|  | 63             | 6710063                |
|  |                | Artikelgroep: 01.02.60 |



|   | Afmeting    | Artikelnr.             |
|---|-------------|------------------------|
| <b>6485</b><br><b>Overgangsknie 90°</b><br>- naar stalen buis met kunststof bekleding | 25 x 3/4"   | 6485025034             |
|   | 32 x 1"     | 6485032100             |
|   | 40 x 1 1/4" | 6485040114             |
|   | 50 x 1 1/2" | 6485050112             |
|   | 63 x 2"     | 6485063200             |
|   |             | Artikelgroep: 01.02.60 |



|   | Afmeting in mm | Artikelnr.             |
|---|----------------|------------------------|
| <b>2635</b><br><b>Steekafsluiter*</b><br>- voor kunststof dienstleidingen<br>- 2 x PE mof | 25 x 25        | 2635025                |
|   | 32 x 32        | 2635032                |
|   | 40 x 40        | 2635040                |
|   | 50 x 50        | 2635050                |
|   | 63 x 63        | 2635063                |
|   |                | Artikelgroep: 01.02.60 |



\* Artikelnr. 2630W: Steekafsluiter voor water.

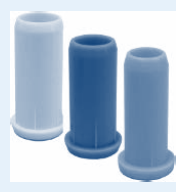
|  | Afmeting in mm | Artikelnr.             |
|--|----------------|------------------------|
| <b>6932</b><br><b>Trekring</b><br>- voor PE buis | 20             | 6932020                |
|  | 25             | 6932025                |
|  | 32             | 6932032                |
|  | 40             | 6932040                |
|  | 50             | 6932050                |
|  | 63             | 6932063                |
|  |                | Artikelgroep: 01.02.60 |



|   | Afmeting     | Artikelnr. |
|---|--------------|------------|
| <b>9053</b><br><b>Inbouwgarntuur</b><br>- compleet met verlengspindel, schutbuis en afdekkap<br>- geschikt voor artikelnr. 2635<br>- 1 meter gronddekking<br>- compleet met breukstuk | 20 t/m 63 mm | 9053       |
|   |              |            |



|  | Afmeting in mm | Drukklasse       | Artikelnr.             |
|--|----------------|------------------|------------------------|
| <b>6031</b><br><b>Kunststof steunbus</b><br>- alleen voor PE 100 gasbuis<br>- met Gastec QA merk | 25 x 2,3       | SDR17,6 Geel     | 6031025A               |
|  | 32 x 2,3       | SDR17,6 Geel     | 6031032A               |
|  | 40             | SDR17,6 Wit      | 6031040B               |
|  | 50             | SDR17,6 Wit      | 6031050B               |
|  | 63             | SDR17,6 Wit      | 6031063B               |
|  | 20             | SDR11/17,6 Grijs | 6031020C               |
|  | 25 x 3,0       | SDR11 Oranje     | 6031025D               |
|  | 32 x 3,0       | SDR11 Grijs      | 6031032C               |
|  | 40             | SDR11 Grijs      | 6031040C               |
|  | 50             | SDR11 Grijs      | 6031050C               |
| 63   | SDR11 Grijs    | 6031063C         |                        |
|  |                |                  | Artikelgroep: 01.02.60 |




# 01.02 Fittingen voor PE drukleidingen

## Messing Beulco koppelingen


- Zware uitvoering.
- Met KIWA-keur waar van toepassing, voor zachte en harde polyethyleen leidingen.
- Koppelingen worden standaard zonder steunbus, artikelnr. 9609, geleverd.

01


|   | Afmeting in mm | Artikelnr.             |
|---|----------------|------------------------|
| <b>9600</b><br>Rechte koppeling<br>- 2 x tyleen | 16             | 9600016                |
|   | 20             | 9600020                |
|   | 25             | 9600025                |
|   | 32             | 9600032                |
|   | 40             | 9600040                |
|   | 50             | 9600050                |
|   | 63             | 9600063                |
|   | 75             | 9600075                |
|   |                | Artikelgroep: 01.02.65 |



|   | Afmeting    | Artikelnr.             |
|---|-------------|------------------------|
| <b>9601</b><br>Overgangs-koppeling<br>- tyleen x<br>binnendraad | 20 x 1/2"   | 9601020012             |
|   | 25 x 3/4"   | 9601025034             |
|   | 32 x 1"     | 9601032100             |
|   | 40 x 1 1/4" | 9601040114             |
|   | 50 x 1 1/2" | 9601050112             |
|   | 63 x 2"     | 9601063200             |
|   | 75 x 2 1/2" | 9601075212             |
|   |             | Artikelgroep: 01.02.65 |




|  | Afmeting    | Artikelnr.             |
|--|-------------|------------------------|
| <b>96011</b><br>Overgangs-koppeling<br>- tyleen x<br>buitendraad | 20 x 1/2"   | 96010200121            |
|  | 25 x 3/4"   | 96010250341            |
|  | 32 x 1"     | 96010321001            |
|  | 40 x 1 1/4" | 96010401141            |
|  | 50 x 1 1/2" | 96010501121            |
|  | 63 x 2"     | 96010632001            |
|  | 75 x 2 1/2" | 96010752121            |
|  |             | Artikelgroep: 01.02.65 |



|   | Afmeting    | Artikelnr.             |
|---|-------------|------------------------|
| <b>9608</b><br>Overgangs-koppeling<br>- tyleen x<br>binnendraad<br>- verhoogd | 16 x 1/2"   | 9608016012             |
|   | 20 x 3/4"   | 9608020034             |
|   | 25 x 1"     | 9608025100             |
|   | 32 x 1 1/4" | 9608032114             |
|   | 40 x 1 1/2" | 9608040112             |
|   | 50 x 2"     | 9608050200             |
|   |             | Artikelgroep: 01.02.65 |



|  | Afmeting    | Artikelnr.             |
|--|-------------|------------------------|
| <b>96081</b><br>Overgangs-koppeling<br>- tyleen x<br>buitendraad<br>- verhoogd | 16 x 1/2"   | 96080160121            |
|  | 20 x 3/4"   | 96080200341            |
|  | 25 x 1"     | 96080251001            |
|  | 32 x 1 1/4" | 96080321141            |
|  | 40 x 1 1/2" | 96080401121            |
|  | 50 x 2"     | 96080502001            |
|  |             | Artikelgroep: 01.02.65 |



|  | Afmeting in mm | Artikelnr.             |
|--|----------------|------------------------|
| <b>9602</b><br>Overgangs-koppeling<br>- tyleen x<br>capillair-soldeerbus | 16 x 15        | 9602016015             |
|  | 20 x 15        | 9602020015             |
|  | 25 x 22        | 9602025022             |
|  | 32 x 28        | 9602032028             |
|  | 40 x 35        | 9602040035             |
|  | 50 x 42        | 9602050042             |
|  | 63 x 54        | 9602063054             |
|  |                | Artikelgroep: 01.02.65 |



|  | Afmeting    | Artikelnr.             |
|--|-------------|------------------------|
| <b>9607</b><br>Overgangs-koppeling<br>- tyleen x<br>buitendraad<br>- gereduceerd | 25 x 1/2"   | 9607025012             |
|  | 32 x 3/4"   | 9607032034             |
|  | 40 x 1"     | 9607040100             |
|  | 50 x 1 1/4" | 9607050114             |
|  | 63 x 1 1/2" | 9607063112             |
|  | 75 x 2"     | 9607075200             |
|  |             | Artikelgroep: 01.02.65 |




|  | Afmeting    | Artikelnr.             |
|--|-------------|------------------------|
| <b>9606</b><br>Overgangsknie*<br>- tyleen x<br>buitendraad | 16 x 3/8"   | 9606016038             |
|  | 20 x 1/2"   | 9606020012             |
|  | 25 x 3/4"   | 9606025034             |
|  | 32 x 1"     | 9606032100             |
|  | 40 x 1 1/4" | 9606040114             |
|  | 50 x 1 1/2" | 9606050112             |
|  | 63 x 2"     | 9606063200             |
|  | 75 x 2 1/2" | 9606075212             |
|  |             | Artikelgroep: 01.02.65 |



\* Met koppeling binnendraad kan een kniekoppeling 2 x tyleen worden gemaakt.

|                                       | Afmeting in mm | Artikelnr.             |
|---------------------------------------|----------------|------------------------|
| <b>9603</b><br>T-stuk<br>- 3 x tyleen | 16             | 9603016                |
|                                       | 20             | 9603020                |
|                                       | 25             | 9603025                |
|                                       | 32             | 9603032                |
|                                       | 40             | 9603040                |
|                                       | 50             | 9603050                |
| 63                                    | 9603063        |                        |
|                                       |                | Artikelgroep: 01.02.65 |



# Fittingen voor PE drukleidingen 01.02


## Messing Beulco koppelingen

|                          | Afmeting    | Artikelnr.             |
|--------------------------|-------------|------------------------|
| <b>9604</b>              | 25 x 3/4"   | 9604025034             |
| <b>Overgangs T-stuk*</b> | 32 x 1"     | 9604032100             |
| - 2 x tyleen             | 40 x 1 1/4" | 9604040114             |
| - met buitendraad        |             | Artikelgroep: 01.02.65 |



\* Met koppeling binnendraad kan een verloop T-stuk worden gemaakt.

|                 | Afmeting in mm | Artikelnr.             |
|-----------------|----------------|------------------------|
| <b>9609</b>     | 16 x 1,6 / 1,8 | 960901618              |
| <b>Steunbus</b> | 20 x 1,9 / 2,0 | 960902020              |
|                 | 20 x 2,1 / 2,2 | 960902022              |
|                 | 25 x 1,9 / 2,0 | 960902520              |
|                 | 25 x 2,2 / 2,3 | 960902523              |
|                 | 25 x 2,7       | 960902527              |
|                 | 32 x 1,9 / 2,0 | 960903220              |
|                 | 32 x 2,9 / 3,0 | 960903230              |
|                 | 32 x 3,5       | 960903235              |
|                 | 40 x 2,3       | 960904023              |
|                 | 40 x 3,6 / 3,7 | 960904037              |
|                 | 40 x 4,3       | 960904043              |
|                 | 50 x 2,9       | 960905029              |
|                 | 50 x 4,5 / 4,6 | 960905046              |
|                 | 50 x 5,4       | 960905054              |
|                 | 63 x 3,6       | 960906336              |
|                 | 63 x 5,7 / 5,8 | 960906358              |
|                 | 63 x 6,8       | 960906368              |
|                 | 75 x 4,3       | 960907543              |
|                 | 75 x 6,8 / 6,9 | 960907569              |
|                 | 75 x 8,1       | 960907581              |
|                 |                | Artikelgroep: 01.02.65 |



01

# Afsluiters voor PE drukleidingen 01.03

## Plasson PE/PP afsluiters


**PLASSON**

|  | Afmeting | Artikelnr.             |
|--|----------|------------------------|
| <b>3703*</b>   | 3/4"     | 37030034               |
| <b>Kogelkraan glasvezel versterkt PA</b>                 | 1"       | 37030100               |
| - 2 x binnendraad  | 1 1/4"   | 37030114               |
| - optionele drainpoort                                   | 1 1/2"   | 37030112               |
| - volle doorlaat   | 2"       | 37030200               |
| - geen metalen onderdelen                                |          | Artikelgroep: 01.03.05 |
| - dubbele afdichting op de spindel                       |          |                        |
| - verwijderbare handle                                   |          |                        |
| - zeer sterke behuizing van glasvezelversterkt polyamide |          |                        |
| - geschikt tot PN16                                      |          |                        |




\* Artikelnr. 3703F: Plasson kogelkraan met aftap.

|                      | Afmeting in mm | Artikelnr.             |
|----------------------|----------------|------------------------|
| <b>3625</b>          | 25             | 3625025                |
| <b>PE Kogelkraan</b> | 32             | 3625032                |
|                      | 40             | 3625040                |
|                      | 50             | 3625050                |
|                      | 63             | 3625063                |
|                      | 75             | 3625075                |
|                      | 90             | 3625090                |
|                      | 110 *          | 3625110                |
|                      | 125 *          | 3625125                |
|                      | 160 *          | 3625160                |
|                      |                | Artikelgroep: 01.03.05 |



\* Gereduceerde doorlaat.

|                              | Bereik in mm | Afmeting in mm | Artikelnr.             |
|------------------------------|--------------|----------------|------------------------|
| <b>3008</b>                  | 600 - 900    | 25-125         | 30080251250900         |
| <b>Inbouw-garnituur</b>      | 700 - 1300   | 25-160         | 30080251601300         |
| - voor artikelnr. 3625       | 900 - 1400   | 25-160         | 30080251601400         |
| - gegalvaniseerd met PE huls | 1300 - 2100  | 25-160         | 30080251602100         |
|                              |              |                | Artikelgroep: 01.03.05 |
|                              |              | Lengte in mm   | Artikelnr.             |
| <b>3009</b>                  |              | 90             | 30090090               |
| <b>T-sleutel</b>             |              | 1000           | 30091000               |
| - voor artikelnr. 3625       |              |                |                        |



# 01.03 Afsluiters voor PE drukleidingen

## Plasson PE/PP afsluiters



01


|   | Afmeting | Artikelnr.             |
|---|----------|------------------------|
| <b>3405</b><br>PP Schuifafsluiter<br>- 2 x cilindrisch<br>binnendraad | 3/4"     | 3405034                |
|   | 1"       | 3405100                |
|   |          | Artikelgroep: 01.03.05 |



|  | Afmeting | Artikelnr.             |
|--|----------|------------------------|
| <b>3049</b><br>Vrijstroomafsluiter<br>- 2 x buitendraad<br>- Viton (FPM)<br>afdichting | 1/2"     | 3049012                |
|  | 3/4"     | 3049034                |
|  | 1"       | 3049100                |
|  | 1 1/4"   | 3049114                |
|  | 1 1/2"   | 3049112                |
|  | 2"       | 3049200                |
|  |          | Artikelgroep: 01.03.05 |



|   | Afmeting in mm | Artikelnr.             |
|---|----------------|------------------------|
| <b>3407</b><br>Stopkraan<br>- 2 x klemkoppeling | 20             | 3407020                |
|   | 25             | 3407025                |
|   | 32             | 3407032                |
|   |                | Artikelgroep: 01.03.05 |



|                                  | Afmeting | Artikelnr.             |
|----------------------------------|----------|------------------------|
| <b>3039</b><br>Snelkoppelventiel | 3/4"     | 3039034                |
|                                  | 1"       | 3039100                |
|                                  |          | Artikelgroep: 01.03.05 |



|   | Afmeting in mm | Artikelnr.             |
|---|----------------|------------------------|
| <b>3046</b><br>Vrijstroomafsluiter<br>- 2 x klemkoppeling | 32             | 3046032                |
|   |                | Artikelgroep: 01.03.05 |



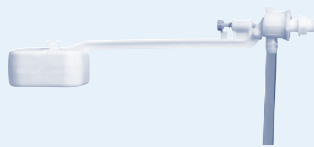
|   | Afmeting | Artikelnr.             |
|---|----------|------------------------|
| <b>3139</b><br>Insteeksleutel<br>- voor artikelnr. 3039 | 3/4"     | 3139034                |
|   |          | Artikelgroep: 01.03.05 |




|   | Afmeting | Artikelnr.             |
|---|----------|------------------------|
| <b>3047</b><br>Vrijstroomafsluiter<br>- 2 x buitendraad | 1/2"     | 3047012                |
|   | 3/4"     | 3047034                |
|   | 1"       | 3047100                |
|   | 1 1/4"   | 3047114                |
|   | 1 1/2"   | 3047112                |
|   | 2"       | 3047200                |
|   |          | Artikelgroep: 01.03.05 |




|  | Afmeting | Artikelnr.             |
|--|----------|------------------------|
| <b>3300</b><br>Plasson vlotter<br>- instelbaar | 1/2"     | 3300                   |
|  |          | Artikelgroep: 01.03.05 |



|  | Afmeting               | Artikelnr. |
|--|------------------------|------------|
| <b>3048</b><br>Vrijstroomafsluiter<br>- klem x buitendraad | 20 x 1/2"              | 3048020012 |
|  | 25 x 3/4"              | 3048025034 |
|  | 32 x 1"                | 3048032100 |
|  | 40 x 1 1/4"            | 3048040114 |
|  | 50 x 1 1/2"            | 3048050112 |
|  | 63 x 2"                | 3048063200 |
|  | Artikelgroep: 01.03.05 |            |



|  | Afmeting               | Artikelnr. |
|--|------------------------|------------|
| <b>3067</b><br>PP Terugslagklep<br>- veerbelast<br>- 2 x buitendraad | 3/4"                   | 3067034    |
|  | 1"                     | 3067100    |
|  | 1 1/4"                 | 3067114    |
|  | 1 1/2"                 | 3067112    |
|  | 2"                     | 3067200    |
|  | Artikelgroep: 01.03.05 |            |



|                           | Afmeting  | Artikelnr.             |
|---------------------------|-----------|------------------------|
| <b>3010</b>               | 16 x 1/2" | 3010016012             |
| <b>Mini afsluiter PN4</b> | 16 x 3/4" | 3010016034             |
| - klem x buitendraad      |           | Artikelgroep: 01.03.05 |



|                                | Afmeting    | Artikelnr.             |
|--------------------------------|-------------|------------------------|
| <b>3013</b>                    | 1/2" x 1/2" | 3013012012             |
| <b>Mini afsluiter PN4</b>      | 1/2" x 3/4" | 3013012034             |
| - slangkoppeling x binnendraad |             | Artikelgroep: 01.03.05 |



|                           | Afmeting  | Artikelnr.             |
|---------------------------|-----------|------------------------|
| <b>3011</b>               | 16 x 1/2" | 3011016012             |
| <b>Mini afsluiter PN4</b> | 16 x 3/4" | 3011016034             |
| - klem x binnendraad      |           | Artikelgroep: 01.03.05 |



|                           | Afmeting    | Artikelnr.             |
|---------------------------|-------------|------------------------|
| <b>3016</b>               | 1/2" x 1/2" | 3016012012             |
| <b>Mini afsluiter PN4</b> |             | Artikelgroep: 01.03.05 |
| - slangtule x binnendraad |             |                        |



|                             | Afmeting    | Artikelnr.             |
|-----------------------------|-------------|------------------------|
| <b>3012</b>                 | 1/2" x 1/2" | 3012012012             |
| <b>Mini afsluiter PN4</b>   | 3/4" x 3/4" | 3012034034             |
| - buitendraad x binnendraad |             | Artikelgroep: 01.03.05 |



|                           | Afmeting in mm | Artikelnr.             |
|---------------------------|----------------|------------------------|
| <b>3017</b>               | 16 x 16        | 3017016016             |
| <b>Mini afsluiter PN4</b> |                | Artikelgroep: 01.03.05 |
| - klem x klem             |                |                        |



# 01.03 Afsluiters voor PE drukleidingen

## PE Spie-laseind voor afsluiters

- Onderstaande afsluiters zijn geschikt voor PE en PP leidingen.
- Voor PE leidingen altijd een PE spie-laseind toepassen!

01

|   | Afmeting in mm | Artikelnr.             |
|---|----------------|------------------------|
| <b>1220</b><br><b>PE Spie-laseind</b><br>- voor het monteren van<br>PP afsluiters tussen PE leidingen<br>- kort model voor spiegelglas* | 16             | 1220016                |
|   | 20             | 1220020                |
|   | 25             | 1220025                |
|   | 32             | 1220032                |
|   | 40             | 1220040                |
|   | 50             | 1220050                |
|   | 63             | 1220063                |
|   | 75             | 1220075                |
|   | 90             | 1220090                |
|   | 110            | 1220110                |
|   |                | Artikelgroep: 03.03.05 |



\* Verlengen van PE spie-laseind voor elektrolas is mogelijk tegen een meerprijs.

## Overige PP afsluiters

|  | Afmeting in mm | Artikelnr.             |
|--|----------------|------------------------|
| <b>1225</b><br><b>PP Kogelkraan</b><br>- PP spie-laseinden voor<br>spiegelglasverbindingen<br>- FPM (Viton) afdichtingen*<br>- met veiligheidshendel | 16             | 1225016                |
|  | 20             | 1225020                |
|  | 25             | 1225025                |
|  | 32             | 1225032                |
|  | 40             | 1225040                |
|  | 50             | 1225050                |
|  | 63             | 1225063                |
|  | 75             | 1225075                |
|  | 90             | 1225090                |
|  | 110            | 1225110                |
|  |                | Artikelgroep: 03.03.05 |



\* Artikelnr. 1232: PP Kogelkraan met EPDM afdichting.

|  | Afmeting in mm | Artikelnr.             |
|--|----------------|------------------------|
| <b>1231</b><br><b>PP Moflas kogelkraan</b><br>- voor moflassen<br>- EPDM afdichting* | 16             | 1231016                |
|  | 20             | 1231020                |
|  | 25             | 1231025                |
|  | 32             | 1231032                |
|  | 40             | 1231040                |
|  | 50             | 1231050                |
|  | 63             | 1231063                |
|  | 75             | 1231075                |
|  | 90             | 1231090                |
|  | 110            | 1231110                |
|  |                | Artikelgroep: 03.03.05 |



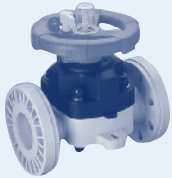
\* Artikelnr. 1230: PP Moflas kogelkraan met FPM (viton) afdichting.

|  | Afmeting in mm | Artikelnr.             |
|--|----------------|------------------------|
| <b>1226</b><br><b>PP Membraanafsluiter</b><br>- PP spie-laseinden voor<br>spiegelglasverbindingen<br>- EPDM membraan | 20             | 1226020                |
|  | 25             | 1226025                |
|  | 32             | 1226032                |
|  | 40             | 1226040                |
|  | 50             | 1226050                |
|  | 63             | 1226063                |
|  | 75             | 1226075                |
|  | 90             | 1226090                |
|  | 110            | 1226110                |
|  |                | Artikelgroep: 03.03.05 |



## Overige PP afsluiters

|   | Afmeting    | Artikelnr.             |
|---|-------------|------------------------|
| <b>1227</b><br><b>PP Membraanafsluiter</b><br>- met flensaansluiting<br>- EPDM afdichtingen | 20 (1/2")   | 1227020                |
|   | 25 (3/4")   | 1227025                |
|   | 32 (1")     | 1227032                |
|   | 40 (1 1/4") | 1227040                |
|   | 50 (1 1/2") | 1227050                |
|   | 63 (2")     | 1227063                |
|   | 75 (2 1/2") | 1227075                |
|   | 90 (3")     | 1227090                |
|   | 110 (4")    | 1227110                |
|   | 125 (5")    | 1227125                |
|   |             | Artikelgroep: 03.03.05 |



|  | Afmeting       | Doorlaat in mm | Artikelnr. |
|--|----------------|----------------|------------|
| <b>6308</b><br><b>PP Terugslagklep</b> | 63 DN 50       | 32             | 6308063    |
|  | 75 DN 65       | 40             | 6308075    |
|  | 90 DN 80       | 52             | 6308090    |
|  | 110 DN 100     | 70             | 6308110    |
|  | 125/140 DN 125 | 92             | 6308125    |
|  | 160 DN 150     | 112            | 6308160    |
|  | 200/225 DN 200 | 150            | 6308200    |
|  | 250/280 DN 250 | 190            | 6308250    |
|  | 315 DN 300     | 216            | 6308315    |
|  |                |                |            |



|   | Afmeting in mm | Artikelnr.             |
|---|----------------|------------------------|
| <b>1228</b><br><b>PP Terugslagklep</b><br>- veerbelast<br>- PP spie-laseinden voor spiegelasverbindingen<br>- FPM (Viton) afdichtingen*<br>- veer is met PTFE bekleed | 16             | 1228016                |
|   | 20             | 1228020                |
|   | 25             | 1228025                |
|   | 32             | 1228032                |
|   | 40             | 1228040                |
|   | 50             | 1228050                |
|   | 63             | 1228063                |
|   | 75             | 1228075                |
|   | 90             | 1228090                |
|   | 110            | 1228110                |
|   |                | Artikelgroep: 03.03.05 |



\* Artikelnr. 1233: PP Terugslagklep met EPDM afdichting.

|  | Afmeting     | Artikelnr.             |
|--|--------------|------------------------|
| <b>1229</b><br><b>PP Vlinderklep</b><br>- FPM (Viton) afdichtingen*<br>- met veiligheidshendel<br>- zware industriekwaliteit | 90 (3")      | 1229090                |
|  | 110 (4")     | 1229110                |
|  | 125/140 (5") | 1229125                |
|  | 160 (6")     | 1229160                |
|  | 200/225 (8") | 1229200                |
|  |              | Artikelgroep: 03.03.05 |



\* Artikelnr. 1235: PP Vlinderklep met EPDM afdichting.

Voor afstandbediende afsluiters verwijzen wij u naar Groep 4 'Afstandbediende afsluiters'.



# 01.04 Toebehoren voor PE drukleidingen

## Reiniger

01



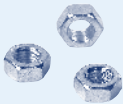
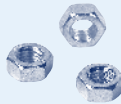


|  | Inhoud in ml | Artikelnr.                         |
|--|--------------|------------------------------------|
| <b>1711</b><br><b>PE Reiniger</b><br>- voor het reinigen van PE/PP | fles 1000    | 17111000<br>Artikelgroep: 19.01.05 |



|   | Inhoud             | Artikelnr.                         |
|---|--------------------|------------------------------------|
| <b>17111</b><br><b>Reinigingsdoekjes</b><br>- voor het reinigen van PE/PP | flacon à 100 stuks | 17110001<br>Artikelgroep: 19.01.05 |



## Bouten, moeren en sluitringen

| Artikelnr.   |   | Artikelnr.  |   |
|--|---|---|---|
| <b>5904</b><br><b>Bout</b><br>- elektrolytisch verzinkt<br>- kwaliteit: 8.8      |  | <b>59041</b><br><b>RVS Bout</b><br>- kwaliteit: A4      |   |
| <b>5905</b><br><b>Moer</b><br>- elektrolytisch verzinkt<br>- kwaliteit: 8.8      |  | <b>59051</b><br><b>RVS Moer</b><br>- kwaliteit: A4      |  |
| <b>5906</b><br><b>Sluitring</b><br>- elektrolytisch verzinkt<br>- kwaliteit: 8.8 |  | <b>59061</b><br><b>RVS Sluitring</b><br>- kwaliteit: A4 |  |

Voor afmetingen verwijzen wij u naar Groep 20 'Bevestigingsmaterialen'.

# Productgroep 02

PE Drukleidingen > PVC Drukleidingen > PP Drukleidingen  
> Afstandbediende afsluiters > C-PVC Programma >  
Blue-system programma > Binnen- en buitenriolering  
> Kabelbescherming en telecom > Milieu programma  
> Tanks > Folie en geotextielen > Halffabrikaten >  
RVS Programma > Malleable programma > Sanitair  
en verwarming > Metalen appendages en fittingen >  
Slangen en koppelingen > Pompen, filters en kabel  
> Lijm, reiniger en toebehoren > Bevestigingsmaterialen >  
Machines en gereedschappen

>> PVC Drukleidingen

# Milder

— VEELZIJDIG IN LEIDINGSYSTEMEN —

# 02.01 PVC Drukbuis

## PVC Drukbuis

- Met KIWA-keur (waar van toepassing).
- Kleur: donkergrijs RAL 7011.
- Lengten: standaard op 5 meter.

|                 | Buitendiameter<br>x wanddikte in mm | Artikelnr. |
|-----------------|-------------------------------------|------------|
| <b>1999</b>     | 50 x 2,0                            | 1999050    |
| <b>PVC Buis</b> | 63 x 2,0                            | 1999063    |
| - met lijmmof   | 75 x 2,2                            | 1999075    |
| - PN7,5         | 90 x 2,7                            | 1999090    |
|                 | 110 x 3,2                           | 1999110    |
|                 | 125 x 3,7                           | 1999125    |
|                 | 160 x 4,7                           | 1999160    |
|                 | 200 x 5,9                           | 1999200    |
|                 | 250 x 7,3                           | 1999250    |
|                 | 315 x 9,2                           | 1999315    |
|                 | 400 x 11,7                          | 1999400    |
|                 | 500 x 14,6                          | 1999500    |

Artikelgroep: 02.01.05



|                 | Buitendiameter<br>x wanddikte in mm | Artikelnr. |
|-----------------|-------------------------------------|------------|
| <b>1001</b>     | 25 x 1,5                            | 1001025    |
| <b>PVC Buis</b> | 32 x 1,6                            | 1001032    |
| - met lijmmof   | 40 x 1,9                            | 1001040    |
| - PN10          | 50 x 2,4                            | 1001050    |
|                 | 63 x 2,4                            | 1001063    |
|                 | 75 x 2,9                            | 1001075    |
|                 | 90 x 3,5                            | 1001090    |
|                 | 110 x 4,2                           | 1001110    |
|                 | 125 x 4,8                           | 1001125    |
|                 | 160 x 6,2                           | 1001160    |
|                 | 200 x 7,7                           | 1001200    |
|                 | 250 x 9,6                           | 1001250    |
|                 | 315 x 12,1                          | 1001315    |

Artikelgroep: 02.01.05



Voor reparatiekoppelingen, zie blz. 96 artikelnr. 7901.

|                 | Buitendiameter<br>x wanddikte in mm | Artikelnr. |
|-----------------|-------------------------------------|------------|
| <b>1002</b>     | 63 x 3,0                            | 1002063    |
| <b>PVC Buis</b> | 75 x 3,6                            | 1002075    |
| - met lijmmof   | 90 x 4,3                            | 1002090    |
| - PN12,5        | 110 x 5,3                           | 1002110    |
|                 | 125 x 6,0                           | 1002125    |
|                 | 160 x 7,7                           | 1002160    |
|                 | 200 x 9,6                           | 1002200    |
|                 | 250 x 11,9                          | 1002250    |
|                 | 315 x 15,0                          | 1002315    |

Artikelgroep: 02.01.05



|                   | Buitendiameter<br>x wanddikte in mm | Artikelnr. |
|-------------------|-------------------------------------|------------|
| <b>1003</b>       | 16 x 1,5                            | 1003016    |
| <b>PVC Buis</b>   | 20 x 1,5                            | 1003020    |
| - glad            | 25 x 1,9                            | 1003025    |
| - PN16            | 32 x 2,4                            | 1003032    |
| - lengte: 4 meter | 40 x 3,0                            | 1003040    |
|                   | 50 x 3,7                            | 1003050    |
|                   | 63 x 3,8                            | 1003063    |

Artikelgroep: 02.01.05



Voor grotere diameters zie blz. 75, PVC Industriebuis.

## PVC Drukbuis met manchet

- Kleur: donkergrijs RAL 7011.
- Lengten: standaard op 5 meter.

|                  | Buitendiameter<br>x wanddikte in mm | Artikelnr. |
|------------------|-------------------------------------|------------|
| <b>1995</b>      | 75 x 2,2                            | 1995075    |
| <b>PVC Buis</b>  | 90 x 2,7                            | 1995090    |
| - met manchetmof | 110 x 3,3                           | 1995110    |
| - PN7,5          | 125 x 3,7                           | 1995125    |
|                  | 160 x 4,7                           | 1995160    |

Artikelgroep: 02.01.10



|                  | Buitendiameter<br>x wanddikte in mm | Artikelnr. |
|------------------|-------------------------------------|------------|
| <b>1996</b>      | 75 x 2,9                            | 1996075    |
| <b>PVC Buis</b>  | 90 x 3,5                            | 1996090    |
| - met manchetmof | 110 x 4,2                           | 1996110    |
| - PN10           | 125 x 4,8                           | 1996125    |
|                  | 160 x 6,2                           | 1996160    |
|                  | 200 x 7,7                           | 1996200    |
|                  | 250 x 9,6                           | 1996250    |
|                  | 315 x 12,1                          | 1996315    |

Artikelgroep: 02.01.10



|                  | Buitendiameter<br>x wanddikte in mm | Artikelnr. |
|------------------|-------------------------------------|------------|
| <b>1997</b>      | 75 x 3,6                            | 1997075    |
| <b>PVC Buis</b>  | 90 x 4,3                            | 1997090    |
| - met manchetmof | 110 x 5,3                           | 1997110    |
| - PN12,5         | 125 x 6,0                           | 1997125    |
|                  | 160 x 7,7                           | 1997160    |
|                  | 200 x 9,6                           | 1997200    |

Artikelgroep: 02.01.10



Voor bijbehorende fittingen zie groep 2, vanaf blz. 96.

## PVC Industriebuis

- Kleur: donkergrijs RAL 7011.
- Lengten: standaard op 5 meter.

|                          | Buitendiameter<br>x wanddikte in mm | Artikelnr. |
|--------------------------|-------------------------------------|------------|
| <b>1070</b>              | 75 x 1,8                            | 1070075    |
| <b>PVC Industriebuis</b> | 90 x 1,8                            | 1070090    |
| - glad                   | 110 x 2,2                           | 1070110    |
| - PN4                    | 125 x 2,5                           | 1070125    |
|                          | 140 x 2,8                           | 1070140    |
|                          | 160 x 3,2                           | 1070160    |
|                          | 180 x 3,6                           | 1070180    |
|                          | 200 x 4,0                           | 1070200    |
|                          | 225 x 4,5                           | 1070225    |
|                          | 250 x 4,9                           | 1070250    |
|                          | 315 x 6,2                           | 1070315    |


Artikelgroep: 02.01.15



## PVC Industriebuis


- Kleur: donkergrijs RAL 7011.
- Lengten: standaard op 5 meter.

|                          | Buitendiameter<br>x wanddikte in mm | Artikelnr. |
|--------------------------|-------------------------------------|------------|
| <b>1071</b>              | 50 x 1,8                            | 1071050    |
| <b>PVC Industriebuis</b> | 63 x 1,9                            | 1071063    |
| - glad                   | 75 x 2,2                            | 1071075    |
| - PN6                    | 90 x 2,7                            | 1071090    |
|                          | 110 x 3,2                           | 1071110    |
|                          | 125 x 3,7                           | 1071125    |
|                          | 140 x 4,1                           | 1071140    |
|                          | 160 x 4,7                           | 1071160    |
|                          | 180 x 5,3                           | 1071180    |
|                          | 200 x 5,9                           | 1071200    |
|                          | 225 x 6,6                           | 1071225    |
|                          | 250 x 7,3                           | 1071250    |
|                          | 315 x 9,2                           | 1071315    |




Artikelgroep: 02.01.15

|                          | Buitendiameter<br>x wanddikte in mm | Artikelnr. |
|--------------------------|-------------------------------------|------------|
| <b>1072</b>              | 25 x 1,5                            | 1072025    |
| <b>PVC Industriebuis</b> | 32 x 1,8                            | 1072032    |
| - glad                   | 40 x 1,9                            | 1072040    |
| - PN10                   | 50 x 2,4                            | 1072050    |
|                          | 63 x 3,0                            | 1072063    |
|                          | 75 x 3,6                            | 1072075    |
|                          | 90 x 4,3                            | 1072090    |
|                          | 110 x 5,3                           | 1072110    |
|                          | 125 x 6,0                           | 1072125    |
|                          | 140 x 6,7                           | 1072140    |
|                          | 160 x 7,7                           | 1072160    |
|                          | 180 x 8,6                           | 1072180    |
|                          | 200 x 9,6                           | 1072200    |
|                          | 225 x 10,8                          | 1072225    |
|                          | 250 x 11,9                          | 1072250    |
|                          | 280 x 13,4                          | 1072280    |
|                          | 315 x 15,0                          | 1072315    |



Artikelgroep: 02.01.15

|                          | Buitendiameter<br>x wanddikte in mm | Artikelnr. |
|--------------------------|-------------------------------------|------------|
| <b>1073</b>              | 16 x 1,2                            | 1073016    |
| <b>PVC Industriebuis</b> | 20 x 1,5                            | 1073020    |
| - glad                   | 25 x 1,9                            | 1073025    |
| - PN16                   | 32 x 2,4                            | 1073032    |
|                          | 40 x 3,0                            | 1073040    |
|                          | 50 x 3,7                            | 1073050    |
|                          | 63 x 4,7                            | 1073063    |
|                          | 75 x 5,6                            | 1073075    |
|                          | 90 x 6,7                            | 1073090    |
|                          | 110 x 8,1                           | 1073110    |
|                          | 125 x 9,3                           | 1073125    |
|                          | 140 x 10,4                          | 1073140    |
|                          | 160 x 11,9                          | 1073160    |
|                          | 180 x 13,4                          | 1073180    |
|                          | 225 x 16,7                          | 1073225    |



Artikelgroep: 02.01.15

|                          | Buitendiameter<br>x wanddikte in mm | Artikelnr. |
|--------------------------|-------------------------------------|------------|
| <b>1074</b>              | 6 x 1,0                             | 1074006    |
| <b>PVC Industriebuis</b> | 8 x 1,0                             | 1074008    |
| - glad                   | 10 x 1,2                            | 1074010    |
| - zwaar                  | 12 x 1,4                            | 1074012    |
| - PN16                   | 16 x 1,8                            | 1074016    |
|                          | 20 x 2,3                            | 1074020    |
|                          | 25 x 2,8                            | 1074025    |
|                          | 32 x 3,6                            | 1074032    |
|                          | 40 x 4,5                            | 1074040    |
|                          | 50 x 5,6                            | 1074050    |
|                          | 63 x 7,0                            | 1074063    |
|                          | 75 x 8,4                            | 1074075    |
|                          | 90 x 10,0                           | 1074090    |
|                          | 110 x 12,3                          | 1074110    |

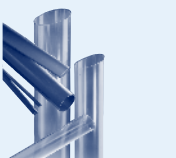


Artikelgroep: 02.01.15

## PVC Transparante buis

- Kleur: transparant.
- Lengten: standaard op 5 meter.

|                              | Buitendiameter<br>x wanddikte in mm | Artikelnr. |
|------------------------------|-------------------------------------|------------|
| <b>1040</b>                  | 6 x 1,0                             | 104000610  |
| <b>PVC Transparante buis</b> | 8 x 1,0                             | 104000810  |
|                              | 10 x 1,2                            | 104001012  |
|                              | 12 x 1,0                            | 104001210  |
|                              | 12 x 1,4                            | 104001214  |
|                              | 16 x 1,2                            | 104001612  |
|                              | 20 x 1,5                            | 104002015  |
|                              | 25 x 1,5                            | 104002515  |
|                              | 25 x 1,9                            | 104002519  |
|                              | 32 x 1,8                            | 104003218  |
|                              | 32 x 2,4                            | 104003224  |
|                              | 40 x 2,0                            | 104004020  |
|                              | 40 x 3,0                            | 104004030  |
|                              | 50 x 1,8                            | 104005018  |
|                              | 50 x 2,4                            | 104005024  |
|                              | 50 x 3,7                            | 104005037  |
|                              | 63 x 1,8                            | 104006318  |
|                              | 63 x 3,0                            | 104006330  |
|                              | 63 x 4,7                            | 104006347  |
|                              | 75 x 1,8                            | 104007518  |
|                              | 75 x 3,6                            | 104007536  |
|                              | 90 x 1,8                            | 104009018  |
|                              | 90 x 4,3                            | 104009043  |
|                              | 110 x 2,2                           | 104011022  |
|                              | 110 x 5,3                           | 104011053  |
|                              | 125 x 2,5                           | 104012525  |
|                              | 140 x 2,8                           | 104014028  |
|                              | 160 x 3,2                           | 104016032  |
|                              | 160 x 4,7                           | 104016047  |
|                              | 200 x 4,0                           | 104020040  |
|                              | 250 x 4,9                           | 104025049  |




Artikelgroep: 02.01.20

# 02.01 PVC Drukbuis

## PVC Filterbuis en toebehoren

- Gemaakt van PVC drukleiding.
- Maatwerk op aanvraag leverbaar.
- Per lengte à 5 meter.

02

|  | Buitendiameter in mm<br>x drukklasse | Sleufbreedte<br>in mm | Lengte perforatie/slit<br>in meter | Artikelnr.   |
|--|--------------------------------------|-----------------------|------------------------------------|--------------|
| <b>1004</b><br>PVC Filterbuis<br> | 32 - PN10                            | 0,3/0,4               | 5                                  | 10040322305  |
|  | 40 - PN10                            | 0,3                   | 5                                  | 10040403405  |
|  | 50 - PN10                            | 0,3                   | 5                                  | 10040504525  |
|  | 63 - PN10                            | 0,3                   | 5                                  | 10040635825  |
|  | 75 - PN10                            | 0,3                   | 5                                  | 10040756925  |
|  | 90 - PN7,5                           | 0,3                   | 3                                  | 10040908463  |
|  | 90 - PN7,5                           | 0,3                   | 5                                  | 10040908465  |
|  | 90 - PN10                            | 0,3                   | 3                                  | 10040908303  |
|  | 90 - PN10                            | 0,3                   | 5                                  | 10040908305  |
|  | 90 - PN10                            | 0,5                   | 5                                  | 10040908307  |
|  | 110 - PN7,5                          | 0,5                   | 3                                  | 100411010343 |
|  | 110 - PN7,5                          | 0,5                   | 5                                  | 100411010345 |
|  | 110 - PN10                           | 0,5                   | 3                                  | 100411010163 |
|  | 110 - PN10                           | 0,5                   | 5                                  | 100411010165 |
|  | 125 - PN7,5                          | 0,5                   | 3                                  | 100412511763 |
|  | 125 - PN7,5                          | 0,5                   | 5                                  | 100412511765 |
|  | 125 - PN10                           | 0,5                   | 5                                  | 100412511525 |
|  | 160 - PN7,5                          | 0,5                   | 5                                  | 100416015065 |
|  | 160 - PN10                           | 0,5                   | 5                                  | 100416014765 |
|  | 160 - PN10                           | 0,8                   | 5                                  | 100416014766 |
|  | 200 - PN7,5                          | 0,5/0,6               | 5                                  | 100420018826 |
|  | 200 - PN7,5                          | 0,8                   | 5                                  | 100420018825 |
|  | 200 - PN10                           | 0,5/0,6               | 5                                  | 100420018466 |
|  | 200 - PN10                           | 0,8                   | 5                                  | 100420018465 |
|  | 250 - PN7,5                          | 0,5/0,6               | 5                                  | 100425023546 |
|  | 250 - PN7,5                          | 0,8                   | 5                                  | 100425023545 |
|  | 315 - PN7,5                          | 0,8                   | 5                                  | 100431529665 |

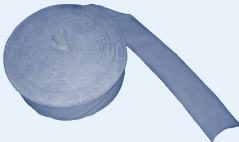
Artikelgroep: 02.01.25

|   | Afmeting<br>in mm | Drukklasse | Artikelnr. |
|---|-------------------|------------|------------|
| <b>10041</b><br>Filterbodem hout<br> | 32                | PN10       | 10040321   |
|   | 40                | PN10       | 10040401   |
|   | 50                | PN10       | 10040501   |
|   | 63                | PN10       | 10040631   |
|   | 75                | PN10       | 10040751   |
|   | 90                | PN10       | 10040901   |
|   | 110               | PN7,5      | 10041101   |
|   | 110               | PN10       | 10041100   |
|   | 125               | PN7,5      | 10041251   |
|   | 125               | PN10       | 10041250   |
|   | 160               | PN7,5      | 10041601   |
|   | 160               | PN10       | 10041600   |
|   | 200               | PN7,5      | 10042001   |
|   | 200               | PN10       | 10042000   |
|   | 250               | PN7,5      | 10042501   |
| 250   | PN10              | 10042500   |            |
| 315   | PN7,5             | 10043151   |            |

Artikelgroep: 02.01.25

|   | Afmeting<br>in mm | Drukklasse | Artikelnr. |
|---|-------------------|------------|------------|
| <b>10042</b><br>Filterbodem<br>kunststof<br> | 32                | PN10       | 10040322   |
|   | 40                | PN10       | 10040402   |
|   | 50                | PN10       | 10040502   |
|   | 63                | PN10       | 10040632   |
|   | 75                | PN10       | 10040752   |
|   | 90                | PN10       | 10040902   |

Artikelgroep: 02.01.25

|   | Afmeting<br>in mm | Geschikt voor<br>filter in mm | Artikelnr. |
|---|-------------------|-------------------------------|------------|
| <b>1006</b><br>Filterkous<br> | 40                | 40 + 50                       | 1006040    |
|   | 50                | 50 + 63                       | 1006050    |
|   | 65                | 75                            | 1006065    |
|   | 80                | 90                            | 1006080    |
|   | 100               | 110 + 125                     | 1006100    |

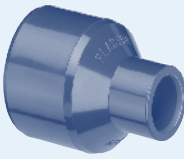
Artikelgroep: 02.01.25

## PVC Drukfittingen met lijmverbinding

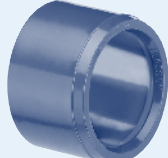
- Met KIWA-keur (waar van toepassing).

|   | Afmeting in mm | Artikelnr. |
|---|----------------|------------|
| <b>5010</b>   | 10             | 5010010    |
|   | 12             | 5010012    |
| <b>PVC Sok</b>  | 16             | 5010016    |
|   | 20             | 5010020    |
|  | 25             | 5010025    |
|   | 32             | 5010032    |
|   | 40             | 5010040    |
|   | 50             | 5010050    |
|   | 63             | 5010063    |
|   | 75             | 5010075    |
|   | 90             | 5010090    |
|   | 110            | 5010110    |
|   | 125            | 5010125    |
|   | 140            | 5010140    |
|   | 160            | 5010160    |
|   | 180            | 5010180    |
|   | 200            | 5010200    |
|   | 225            | 5010225    |
|   | 250            | 5010250    |
|   | 280            | 5010280    |
|   | 315            | 5010315    |
|   | 400            | 5010400    |

Artikelgroep: 02.02.05

|   | Afmeting in mm  | Artikelnr. |
|---|-----------------|------------|
| <b>5020</b>   | 20 x 16 x 16    | 5020020016 |
|   | 25 x 20 x 16    | 5020025016 |
| <b>PVC Verloopstuk</b>  | 25 x 20 x 20    | 5020025020 |
|   | 32 x 25 x 16    | 5020032016 |
|  | 32 x 25 x 20    | 5020032020 |
|   | 32 x 25 x 25    | 5020032025 |
|   | 40 x 32 x 16    | 5020040016 |
|   | 40 x 32 x 20    | 5020040020 |
|   | 40 x 32 x 25    | 5020040025 |
|   | 40 x 32 x 32    | 5020040032 |
|   | 50 x 40 x 20    | 5020050020 |
|   | 50 x 40 x 25    | 5020050025 |
|   | 50 x 40 x 32    | 5020050032 |
|   | 50 x 40 x 40    | 5020050040 |
|   | 63 x 50 x 25    | 5020063025 |
|   | 63 x 50 x 32    | 5020063032 |
|   | 63 x 50 x 40    | 5020063040 |
|   | 63 x 50 x 50    | 5020063050 |
|   | 75 x 63 x 32    | 5020075032 |
|   | 75 x 63 x 40    | 5020075040 |
|   | 75 x 63 x 50    | 5020075050 |
|   | 75 x 63 x 63    | 5020075063 |
|   | 90 x 75 x 40    | 5020090040 |
|   | 90 x 75 x 50    | 5020090050 |
|   | 90 x 75 x 63    | 5020090063 |
|   | 90 x 75 x 75    | 5020090075 |
|   | 110 x 90 x 50   | 5020110050 |
|   | 110 x 90 x 63   | 5020110063 |
|   | 110 x 90 x 75   | 5020110075 |
|   | 110 x 90 x 90   | 5020110090 |
|   | 125 x 110 x 63  | 5020125063 |
|   | 125 x 110 x 75  | 5020125075 |
|   | 125 x 110 x 90  | 5020125090 |
|   | 125 x 110 x 110 | 5020125110 |
|   | 140 x 125 x 110 | 5020140110 |
|   | 160 x 140 x 90  | 5020160090 |
|   | 160 x 140 x 110 | 5020160110 |
|   | 160 x 140 x 125 | 5020160125 |
|   | 225 x 200 x 160 | 5020225160 |

Artikelgroep: 02.02.05

|  | Afmeting in mm | Artikelnr. |
|--|----------------|------------|
| <b>5090</b>  | 16 x 12        | 5090016012 |
|  | 20 x 10        | 5090020010 |
| <b>PVC Verlooping</b>  | 20 x 12        | 5090020012 |
|  | 20 x 16        | 5090020016 |
|  | 25 x 16        | 5090025016 |
|  | 25 x 20        | 5090025020 |
|  | 32 x 16        | 5090032016 |
|  | 32 x 20        | 5090032020 |
|  | 32 x 25        | 5090032025 |
|  | 40 x 20        | 5090040020 |
|  | 40 x 25        | 5090040025 |
|  | 40 x 32        | 5090040032 |
|  | 50 x 20        | 5090050020 |
|  | 50 x 25        | 5090050025 |
|  | 50 x 32        | 5090050032 |
|  | 50 x 40        | 5090050040 |
|  | 63 x 25        | 5090063025 |
|  | 63 x 32        | 5090063032 |
|  | 63 x 40        | 5090063040 |
|  | 63 x 50        | 5090063050 |
|  | 75 x 40        | 5090075040 |
|  | 75 x 50        | 5090075050 |
|  | 75 x 63        | 5090075063 |
|  | 90 x 50        | 5090090050 |
|  | 90 x 63        | 5090090063 |
|  | 90 x 75        | 5090090075 |
|  | 110 x 63       | 5090110063 |
|  | 110 x 75       | 5090110075 |
|  | 110 x 90       | 5090110090 |
|  | 125 x 75       | 5090125075 |
|  | 125 x 90       | 5090125090 |
|  | 125 x 110      | 5090125110 |
|  | 140 x 90       | 5090140090 |
|  | 140 x 110      | 5090140110 |
|  | 140 x 125      | 5090140125 |
|  | 160 x 110      | 5090160110 |
|  | 160 x 125      | 5090160125 |
|  | 160 x 140      | 5090160140 |
|  | 180 x 160      | 5090180160 |
|  | 200 x 110      | 5090200110 |
|  | 200 x 125      | 5090200125 |
|  | 200 x 160      | 5090200160 |
|  | 200 x 180      | 5090200180 |
|  | 225 x 160      | 5090225160 |
|  | 225 x 180      | 5090225180 |
|  | 225 x 200      | 5090225200 |
|  | 250 x 160      | 5090250160 |
|  | 250 x 180      | 5090250180 |
|  | 250 x 200      | 5090250200 |
|  | 250 x 225      | 5090250225 |
|  | 280 x 200      | 5090280200 |
|  | 280 x 225      | 5090280225 |
|  | 280 x 250      | 5090280250 |
|  | 315 x 200      | 5090315200 |
|  | 315 x 225      | 5090315225 |
|  | 315 x 250      | 5090315250 |
|  | 315 x 280      | 5090315280 |
|  | 355 x 315      | 5090355315 |
|  | 400 x 315      | 5090400315 |

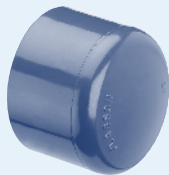
Artikelgroep: 02.02.05

# 02.02 Fittingen voor PVC drukleidingen

## PVC Drukfittingen met lijmverbinding

02

|                               | Afmeting in mm | Artikelnr. |
|-------------------------------|----------------|------------|
| <b>5070</b><br>PVC Afsluitkap | 12             | 5070012    |
|                               | 16             | 5070016    |
|                               | 20             | 5070020    |
|                               | 25             | 5070025    |
|                               | 32             | 5070032    |
|                               | 40             | 5070040    |
|                               | 50             | 5070050    |
|                               | 63             | 5070063    |
|                               | 75             | 5070075    |
|                               | 90             | 5070090    |
|                               | 110            | 5070110    |
|                               | 125            | 5070125    |
|                               | 140            | 5070140    |
|                               | 160            | 5070160    |
|                               | 200            | 5070200    |
|                               | 225            | 5070225    |
|                               | 250            | 5070250    |
|                               | 315            | 5070315    |
| Artikelgroep: 02.02.05        |                |            |



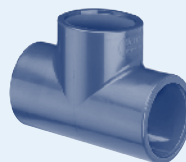
|                              | Afmeting in mm         | Artikelnr. |
|------------------------------|------------------------|------------|
| <b>5550</b><br>PVC Bocht 90° | 20                     | 5550020    |
|                              | 25                     | 5550025    |
|                              | 32                     | 5550032    |
|                              | 40                     | 5550040    |
|                              | 50                     | 5550050    |
|                              | 63                     | 5550063    |
|                              | 75                     | 5550075    |
|                              | 90                     | 5550090    |
|                              | 110                    | 5550110    |
|                              | Artikelgroep: 02.02.05 |            |



|                             | Afmeting in mm | Artikelnr. |
|-----------------------------|----------------|------------|
| <b>5050</b><br>PVC Knie 90° | 10             | 5050010    |
|                             | 12             | 5050012    |
|                             | 16             | 5050016    |
|                             | 20             | 5050020    |
|                             | 25             | 5050025    |
|                             | 32             | 5050032    |
|                             | 40             | 5050040    |
|                             | 50             | 5050050    |
|                             | 63             | 5050063    |
|                             | 75             | 5050075    |
|                             | 90             | 5050090    |
|                             | 110            | 5050110    |
|                             | 125            | 5050125    |
|                             | 140            | 5050140    |
|                             | 160            | 5050160    |
|                             | 180            | 5050180    |
|                             | 200            | 5050200    |
|                             | 225            | 5050225    |
|                             | 250            | 5050250    |
|                             | 280            | 5050280    |
| 315                         | 5050315        |            |
| 400                         | 5050400        |            |
| Artikelgroep: 02.02.05      |                |            |



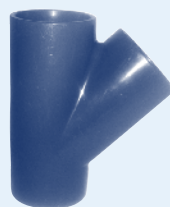
|                               | Afmeting in mm | Artikelnr. |
|-------------------------------|----------------|------------|
| <b>5040</b><br>PVC T-stuk 90° | 12             | 5040012    |
|                               | 16             | 5040016    |
|                               | 20             | 5040020    |
|                               | 25             | 5040025    |
|                               | 32             | 5040032    |
|                               | 40             | 5040040    |
|                               | 50             | 5040050    |
|                               | 63             | 5040063    |
|                               | 75             | 5040075    |
|                               | 90             | 5040090    |
|                               | 110            | 5040110    |
|                               | 125            | 5040125    |
|                               | 140            | 5040140    |
|                               | 160            | 5040160    |
|                               | 180            | 5040180    |
|                               | 200            | 5040200    |
|                               | 225            | 5040225    |
|                               | 250            | 5040250    |
|                               | 280            | 5040280    |
|                               | 315            | 5040315    |
| 400                           | 5040400        |            |
| Artikelgroep: 02.02.05        |                |            |



|                             | Afmeting in mm | Artikelnr. |
|-----------------------------|----------------|------------|
| <b>5450</b><br>PVC Knie 45° | 12             | 5450012    |
|                             | 16             | 5450016    |
|                             | 20             | 5450020    |
|                             | 25             | 5450025    |
|                             | 32             | 5450032    |
|                             | 40             | 5450040    |
|                             | 50             | 5450050    |
|                             | 63             | 5450063    |
|                             | 75             | 5450075    |
|                             | 90             | 5450090    |
|                             | 110            | 5450110    |
|                             | 125            | 5450125    |
|                             | 140            | 5450140    |
|                             | 160            | 5450160    |
|                             | 180            | 5450180    |
|                             | 200            | 5450200    |
|                             | 225            | 5450225    |
|                             | 250            | 5450250    |
|                             | 280            | 5450280    |
|                             | 315            | 5450315    |
| 400                         | 5450400        |            |
| Artikelgroep: 02.02.05      |                |            |

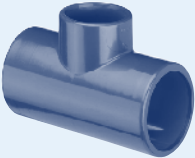


|                               | Afmeting in mm | Artikelnr. |
|-------------------------------|----------------|------------|
| <b>5141</b><br>PVC T-stuk 45° | 16             | 5141016    |
|                               | 20             | 5141020    |
|                               | 25             | 5141025    |
|                               | 32             | 5141032    |
|                               | 40             | 5141040    |
|                               | 50             | 5141050    |
|                               | 63             | 5141063    |
|                               | 75             | 5141075    |
|                               | 90             | 5141090    |
|                               | 110            | 5141110    |
|                               | 125            | 5141125    |
|                               | 140            | 5141140    |
|                               | 160            | 5141160    |
|                               | 200            | 5141200    |
|                               | 250            | 5141250    |
| Artikelgroep: 02.02.05        |                |            |



## PVC Drukfittingen met lijmverbinding

02

|   | Afmeting in mm |     |     | Artikelnr. |            |            |
|---|----------------|-----|-----|------------|------------|------------|
| <b>5140</b><br>PVC Verloop T-stuk<br>90°<br> | 20             | x   | 16  | x          | 20         | 5140020016 |
|   | 25             | x   | 16  | x          | 25         | 5140025016 |
|   | 25             | x   | 20  | x          | 25         | 5140025020 |
|   | 32             | x   | 16  | x          | 32         | 5140032016 |
|   | 32             | x   | 20  | x          | 32         | 5140032020 |
|   | 32             | x   | 25  | x          | 32         | 5140032025 |
|   | 40             | x   | 16  | x          | 40         | 5140040016 |
|   | 40             | x   | 20  | x          | 40         | 5140040020 |
|   | 40             | x   | 25  | x          | 40         | 5140040025 |
|   | 40             | x   | 32  | x          | 40         | 5140040032 |
|   | 50             | x   | 20  | x          | 50         | 5140050020 |
|   | 50             | x   | 25  | x          | 50         | 5140050025 |
|   | 50             | x   | 32  | x          | 50         | 5140050032 |
|   | 50             | x   | 40  | x          | 50         | 5140050040 |
|   | 63             | x   | 20  | x          | 63         | 5140063020 |
|   | 63             | x   | 25  | x          | 63         | 5140063025 |
|   | 63             | x   | 32  | x          | 63         | 5140063032 |
|   | 63             | x   | 40  | x          | 63         | 5140063040 |
|   | 63             | x   | 50  | x          | 63         | 5140063050 |
|   | 75             | x   | 32  | x          | 75         | 5140075032 |
|   | 75             | x   | 40  | x          | 75         | 5140075040 |
|   | 75             | x   | 50  | x          | 75         | 5140075050 |
|   | 75             | x   | 63  | x          | 75         | 5140075063 |
|   | 90             | x   | 40  | x          | 90         | 5140090040 |
|   | 90             | x   | 50  | x          | 90         | 5140090050 |
|   | 90             | x   | 63  | x          | 90         | 5140090063 |
|   | 90             | x   | 75  | x          | 90         | 5140090075 |
|   | 110            | x   | 50  | x          | 110        | 5140110050 |
|   | 110            | x   | 63  | x          | 110        | 5140110063 |
|   | 110            | x   | 75  | x          | 110        | 5140110075 |
|   | 110            | x   | 90  | x          | 110        | 5140110090 |
|   | 125            | x   | 63  | x          | 125        | 5140125063 |
|   | 125            | x   | 75  | x          | 125        | 5140125075 |
|   | 125            | x   | 90  | x          | 125        | 5140125090 |
|   | 125            | x   | 110 | x          | 125        | 5140125110 |
|   | 140            | x   | 75  | x          | 140        | 5140140075 |
|   | 140            | x   | 90  | x          | 140        | 5140140090 |
|   | 140            | x   | 110 | x          | 140        | 5140140110 |
|   | 140            | x   | 125 | x          | 140        | 5140140125 |
|   | 160            | x   | 110 | x          | 160        | 5140160110 |
| 160   | x              | 125 | x   | 160        | 5140160125 |            |
| 160   | x              | 140 | x   | 160        | 5140160140 |            |
| 200   | x              | 110 | x   | 200        | 5140200110 |            |
| 200   | x              | 160 | x   | 200        | 5140200160 |            |
| 225   | x              | 160 | x   | 225        | 5140225160 |            |
| 250   | x              | 110 | x   | 250        | 5140250110 |            |
| 250   | x              | 160 | x   | 250        | 5140250160 |            |
| 250   | x              | 200 | x   | 250        | 5140250200 |            |
| 315   | x              | 160 | x   | 315        | 5140315160 |            |
| 315   | x              | 200 | x   | 315        | 5140315200 |            |
| 315   | x              | 250 | x   | 315        | 5140315250 |            |

Artikelgroep: 02.02.05

|  | Afmeting in mm |  | Artikelnr. |
|--|----------------|--|------------|
| <b>5554</b><br>PVC Kruisstuk 90°<br> | 16             |  | 5554016    |
|  | 20             |  | 5554020    |
|  | 25             |  | 5554025    |
|  | 32             |  | 5554032    |
|  | 40             |  | 5554040    |
|  | 50             |  | 5554050    |
|  | 63             |  | 5554063    |
|  | 75             |  | 5554075    |
|  | 90             |  | 5554090    |
|  | 110            |  | 5554110    |

Artikelgroep: 02.02.05

|   | Afmeting in mm |  | Artikelnr. |
|---|----------------|--|------------|
| <b>5555</b><br>PVC Y-stuk*<br> | 50             |  | 5555050    |
|   | 63             |  | 5555063    |

Artikelgroep: 02.02.05

\* Drukloos.

|   | Afmeting in mm |    | Artikelnr. |         |
|---|----------------|----|------------|---------|
| <b>5360</b><br>PVC Slangtule<br>- met lijmverbinding<br>- spie x pilaar<br> | 10             | x  | 8          | 5360010 |
|   | 10             | x  | 12         | 5360011 |
|   | 12             | x  | 12         | 5360012 |
|   | 16             | x  | 16         | 5360016 |
|   | 20             | x  | 20         | 5360020 |
|   | 25             | x  | 25         | 5360025 |
|   | 32             | x  | 30         | 5360032 |
|   | 40             | x  | 40         | 5360040 |
|   | 50             | x  | 50         | 5360050 |
| 63  | x              | 60 | 5360063    |         |

Artikelgroep: 02.02.05

|   | Afmeting in mm |   | Artikelnr. |   |    |         |
|---|----------------|---|------------|---|----|---------|
| <b>5358</b><br>PVC Slangtule<br>- conisch<br> | 12             | x | 14         | x | 12 | 5358012 |
|   | 16             | x | 18         | x | 16 | 5358016 |
|   | 20             | x | 22         | x | 20 | 5358020 |
|   | 25             | x | 27         | x | 25 | 5358025 |
|   | 32             | x | 32         | x | 30 | 5358032 |
|   | 40             | x | 42         | x | 40 | 5358040 |
|   | 50             | x | 52         | x | 50 | 5358050 |
|   | 63             | x | 64         | x | 60 | 5358063 |

Artikelgroep: 02.02.05

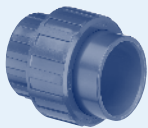


# 02.02 Fittingen voor PVC drukleidingen

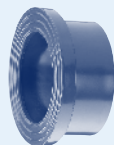
## PVC Drukfittingen met lijmverbinding

02

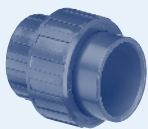
|                               | Afmeting in mm | Artikelnr. |
|-------------------------------|----------------|------------|
| <b>5080</b>                   | 12             | 5080012    |
| <b>PVC 3-Delige koppeling</b> | 16             | 5080016    |
|                               | 20             | 5080020    |
| - met EPDM O-ringen           | 25             | 5080025    |
|                               | 32             | 5080032    |
|                               | 40             | 5080040    |
|                               | 50             | 5080050    |
|                               | 63             | 5080063    |
|                               | 75             | 5080075    |
|                               | 90             | 5080090    |
|                               | 110            | 5080110    |
| Artikelgroep: 02.02.05        |                |            |



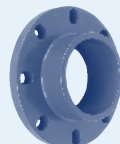
|   | Afmeting in mm | Artikelnr.             |
|---|----------------|------------------------|
| <b>5521</b>   | 125 x 140*     | 5521125                |
| <b>PVC Verloopkraagbus</b>  | 200 x 225*     | 5521200                |
| - mof x flens   | 250 x 280*     | 5521250                |
| - voor grotere flensaansluitingen, zoals vlinderkleppen en terugslagkleppen |                | Artikelgroep: 02.02.05 |
| * Benodigde flensmaat.  |                |                        |



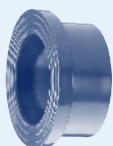
|                               | Afmeting in mm | Artikelnr. |
|-------------------------------|----------------|------------|
| <b>5980</b>                   | 16             | 5980016    |
| <b>PVC 3-Delige koppeling</b> | 20             | 5980020    |
| - met viton O-ringen          | 25             | 5980025    |
|                               | 32             | 5980032    |
|                               | 40             | 5980040    |
|                               | 50             | 5980050    |
|                               | 63             | 5980063    |
| Artikelgroep: 02.02.05        |                |            |



|                               | Afmeting in mm | Artikelnr. |
|-------------------------------|----------------|------------|
| <b>5920</b>                   | 32             | 5920032    |
| <b>PVC Flens met kraagbus</b> | 40             | 5920040    |
| - met lijmverbinding          | 50             | 5920050    |
|                               | 63             | 5920063    |
|                               | 75             | 5920075    |
|                               | 90             | 5920090    |
|                               | 110            | 5920110    |
| Artikelgroep: 02.02.05        |                |            |



|                            | Afmeting in mm | Artikelnr. |
|----------------------------|----------------|------------|
| <b>5520</b>                | 16             | 5520016    |
| <b>PVC Kraagbus gerild</b> | 20             | 5520020    |
| - voor vlakke pakking      | 25             | 5520025    |
|                            | 32             | 5520032    |
|                            | 40             | 5520040    |
|                            | 50             | 5520050    |
|                            | 63             | 5520063    |
|                            | 75             | 5520075    |
|                            | 90             | 5520090    |
|                            | 110            | 5520110    |
|                            | 125            | 5520125    |
|                            | 140            | 5520140    |
|                            | 160            | 5520160    |
|                            | 180            | 5520180    |
|                            | 200            | 5520200    |
|                            | 225            | 5520225    |
|                            | 250            | 5520250    |
|                            | 280            | 5520280    |
|                            | 315            | 5520315    |
|                            | 355            | 5520355    |
|                            | 400            | 5520400    |
|                            | 500            | 5520500    |
| Artikelgroep: 02.02.05     |                |            |



|                        | Afmeting in mm | Artikelnr. |
|------------------------|----------------|------------|
| <b>5629</b>            | 16             | 5629016    |
| <b>EPDM Pakking</b>    | 20             | 5629020    |
|                        | 25             | 5629025    |
|                        | 32             | 5629032    |
|                        | 40             | 5629040    |
|                        | 50             | 5629050    |
|                        | 63             | 5629063    |
|                        | 75             | 5629075    |
|                        | 90             | 5629090    |
|                        | 110            | 5629110    |
|                        | 125            | 5629125    |
|                        | 140            | 5629140    |
|                        | 160            | 5629160    |
|                        | 180            | 5629180    |
|                        | 200            | 5629200    |
|                        | 225            | 5629225    |
|                        | 250            | 5629250    |
|                        | 280            | 5629280    |
|                        | 315            | 5629315    |
|                        | 355            | 5629355    |
|                        | 400            | 5629400    |
|                        | 450            | 5629450    |
|                        | 500            | 5629500    |
| Artikelgroep: 02.02.05 |                |            |



|                            | Afmeting in mm | Artikelnr. |
|----------------------------|----------------|------------|
| <b>5630</b>                | 20             | 5630020    |
| <b>FPM (viton) pakking</b> | 25             | 5630025    |
|                            | 32             | 5630032    |
|                            | 40             | 5630040    |
|                            | 50             | 5630050    |
|                            | 63             | 5630063    |
|                            | 75             | 5630075    |
|                            | 90             | 5630090    |
|                            | 110            | 5630110    |
|                            | 125            | 5630125    |
| Artikelgroep: 02.02.05     |                |            |




Voor flenzen en pakkingen voor PVC leidingen, zie blz. 89.

## PVC Drukfittingen met lijm-/draadverbinding

|   | Afmeting    | Artikelnr. |
|---|-------------|------------|
| <b>5012</b><br><b>PVC Schroefbus</b><br>- mof x binnendraad | 16 x 3/8"   | 5012016038 |
|   | 20 x 1/2"   | 5012020012 |
|   | 25 x 3/4"   | 5012025034 |
|   | 32 x 1"     | 5012032100 |
|   | 40 x 1 1/4" | 5012040114 |
|   | 50 x 1 1/2" | 5012050112 |
|   | 63 x 2"     | 5012063200 |
|   | 75 x 2 1/2" | 5012075212 |
|   | 90 x 3"     | 5012090300 |
|   | 110 x 4"    | 5012110400 |
| Artikelgroep: 02.02.10                                      |             |            |



|   | Afmeting       | Artikelnr. |
|---|----------------|------------|
| <b>5032</b><br><b>PVC Inzet-<br/>verloopsok</b><br>- spie x binnendraad | 20 x 16 x 3/8" | 5032020038 |
|   | 20 x 16 x 1/2" | 5032020012 |
|   | 20 x 16 x 3/4" | 5032020034 |
|   | 25 x 20 x 3/4" | 5032025034 |
|   | 25 x 20 x 1"   | 5032025100 |
|   | 32 x 1"        | 5032032100 |
|   | 40 x 1 1/4"    | 5032040114 |
|   | 50 x 1 1/2"    | 5032050112 |
|   | 63 x 2"        | 5032063200 |
|   | 75 x 2 1/2"    | 5032075212 |
|   | 90 x 3"        | 5032090300 |
|   | 110 x 4"       | 5032110400 |
| Artikelgroep: 02.02.10  |                |            |



\* Spie x mof x binnendraad.

|   | Afmeting               | Artikelnr. |
|---|------------------------|------------|
| <b>5712</b><br><b>PVC Schroefbus</b><br>- mof x binnendraad<br>- met versterkingsring | 16 x 3/8"              | 5712016038 |
|   | 20 x 1/2"              | 5712020012 |
|   | 25 x 3/4"              | 5712025034 |
|   | 32 x 1"                | 5712032100 |
|   | 40 x 1 1/4"            | 5712040114 |
|   | 50 x 1 1/2"            | 5712050112 |
|   | 63 x 2"                | 5712063200 |
|   | Artikelgroep: 02.02.10 |            |



|  | Afmeting               | Artikelnr. |
|--|------------------------|------------|
| <b>5722</b><br><b>PVC Inzet-<br/>schroefbus</b><br>- spie x mof x<br>binnendraad<br>- met versterkingsring | 20 x 16 x 1/2"         | 5722020012 |
|  | 25 x 20 x 1/2"         | 5722025012 |
|  | 25 x 20 x 3/4"         | 5722025034 |
|  | 32 x 25 x 3/4"         | 5722032034 |
|  | 32 x 25 x 1"           | 5722032100 |
|  | 40 x 32 x 1"           | 5722040100 |
|  | 40 x 32 x 1 1/4"       | 5722040114 |
|  | 50 x 40 x 1 1/4"       | 5722050114 |
|  | 50 x 40 x 1 1/2"       | 5722050112 |
|  | 63 x 50 x 1 1/2"       | 5722063112 |
|  | 63 x 50 x 2"           | 5722063200 |
|  | 75 x 63 x 2 1/2"       | 5722075212 |
|  | Artikelgroep: 02.02.10 |            |



|  | Afmeting         | Artikelnr. |
|--|------------------|------------|
| <b>5022</b><br><b>PVC Inzet-<br/>schroefbus</b><br>- spie x mof x<br>binnendraad | 25 x 20 x 1/2"   | 5022025012 |
|  | 32 x 25 x 3/4"   | 5022032034 |
|  | 40 x 32 x 1"     | 5022040100 |
|  | 50 x 40 x 1 1/4" | 5022050114 |
|  | 63 x 50 x 1 1/2" | 5022063112 |
|  | 75 x 63 x 2"     | 5022075200 |
|  | 90 x 75 x 2 1/2" | 5022090212 |
|  | 110 x 90 x 3"    | 5022110300 |
| Artikelgroep: 02.02.10   |                  |            |



|  | Afmeting    | Artikelnr. |
|--|-------------|------------|
| <b>5031</b><br><b>PVC Inlijmring</b><br>- spie x binnendraad<br>- zonder zeskant | 25 x 1/2"   | 5031025012 |
|  | 32 x 3/4"   | 5031032034 |
|  | 40 x 1"     | 5031040100 |
|  | 50 x 1 1/4" | 5031050114 |
|  | 63 x 1 1/2" | 5031063112 |
|  | 75 x 2"     | 5031075200 |
|  | 90 x 2 1/2" | 5031090212 |
|  | 110 x 3"    | 5031110300 |
| 160 x 5"   | 5031160500  |            |
| 200 x 6"   | 5031200600  |            |
| Artikelgroep: 02.02.10   |             |            |



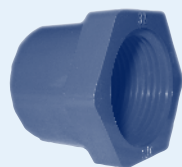
# 02.02 Fittingen voor PVC drukleidingen

## PVC Drukfittingen met lijm-/draadverbinding

02

|                       | Afmeting          | Artikelnr. |
|-----------------------|-------------------|------------|
| <b>5033</b>           | 16 x 1/4"         | 5033016014 |
| <b>PVC Inlijmring</b> | 20 x 1/4"         | 5033020014 |
| - met zeskant         | 20 x 3/8"         | 5033020038 |
| - spie x binnendraad  | 25 x 3/8"         | 5033025038 |
|                       | 25 x 1/2"         | 5033025012 |
|                       | 32 x 1/2"         | 5033032012 |
|                       | 32 x 3/4"         | 5033032034 |
|                       | 40 x 1/2"         | 5033040012 |
|                       | 40 x 3/4"         | 5033040034 |
|                       | 40 x 1"           | 5033040100 |
|                       | 50 x 1/2"         | 5033050012 |
|                       | 50 x 3/4"         | 5033050034 |
|                       | 50 x 1"           | 5033050100 |
|                       | 50 x 1 1/4"       | 5033050114 |
|                       | 63 x 1"           | 5033063100 |
|                       | 63 x 1 1/4"       | 5033063114 |
|                       | 63 x 1 1/2"       | 5033063112 |
|                       | 75 x 1 1/4"       | 5033075114 |
|                       | 75 x 1 1/2"       | 5033075112 |
|                       | 75 x 2"           | 5033075200 |
|                       | 90 x 75 x 2"      | 5033090200 |
|                       | 90 x 2 1/2"       | 5033090212 |
|                       | 110 x 90 x 2"     | 5033110200 |
|                       | 110 x 90 x 2 1/2" | 5033110212 |
|                       | 110 x 3"          | 5033110300 |
|                       | 125 x 3"          | 5033125300 |
|                       | 125 x 4"          | 5033125400 |

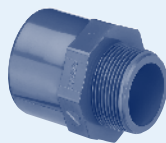
Artikelgroep: 02.02.10



\* Spie x mof x binnendraad.

|                            | Afmeting         | Artikelnr. |
|----------------------------|------------------|------------|
| <b>5212</b>                | 20 x 16 x 3/8"   | 5212020038 |
| <b>PVC Puntstuk</b>        | 25 x 20 x 1/2"   | 5212025012 |
| - spie x mof x buitendraad | 32 x 25 x 3/4"   | 5212032034 |
|                            | 40 x 32 x 1"     | 5212040100 |
|                            | 50 x 40 x 1 1/4" | 5212050114 |
|                            | 63 x 50 x 1 1/2" | 5212063112 |
|                            | 75 x 63 x 2"     | 5212075200 |
|                            | 90 x 75 x 2 1/2" | 5212090212 |
|                            | 110 x 90 x 3"    | 5212110300 |
|                            | 125 x 110 x 4"   | 5212125400 |

Artikelgroep: 02.02.10



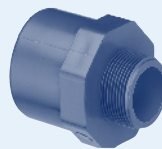
|                            | Afmeting         | Artikelnr. |
|----------------------------|------------------|------------|
| <b>5062</b>                | 16 x 12 x 1/4"   | 5062016014 |
| <b>PVC Puntstuk</b>        | 16 x 12 x 3/8"   | 5062016038 |
| - spie x mof x buitendraad | 20 x 16 x 1/2"   | 5062020012 |
|                            | 25 x 20 x 3/4"   | 5062025034 |
|                            | 32 x 25 x 1"     | 5062032100 |
|                            | 40 x 32 x 1 1/4" | 5062040114 |
|                            | 50 x 40 x 1 1/2" | 5062050112 |
|                            | 63 x 50 x 2"     | 5062063200 |
|                            | 75 x 63 x 2 1/2" | 5062075212 |
|                            | 90 x 75 x 3"     | 5062090300 |
|                            | 110 x 90 x 4"    | 5062110400 |
|                            | 125 x 110 x 5"   | 5062125500 |

Artikelgroep: 02.02.10



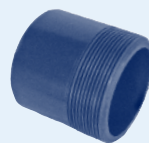
|                            | Afmeting          | Artikelnr. |
|----------------------------|-------------------|------------|
| <b>5222</b>                | 25 x 20 x 3/8"    | 5222025038 |
| <b>PVC Puntstuk</b>        | 32 x 25 x 1/2"    | 5222032012 |
| - spie x mof x buitendraad | 40 x 32 x 3/4"    | 5222040034 |
|                            | 50 x 40 x 1"      | 5222050100 |
|                            | 63 x 50 x 1 1/4"  | 5222063114 |
|                            | 75 x 63 x 1 1/2"  | 5222075112 |
|                            | 90 x 75 x 2"      | 5222090200 |
|                            | 110 x 90 x 2 1/2" | 5222110212 |
|                            | 125 x 110 x 3"    | 5222125300 |

Artikelgroep: 02.02.10



|                     | Afmeting     | Artikelnr. |
|---------------------|--------------|------------|
| <b>1705</b>         | 16 x 1/4"    | 1705016014 |
| <b>PVC Puntstuk</b> | 16 x 3/8"    | 1705016038 |
| - handvorm          | 20 x 3/8"    | 1705020038 |
| - mof x buitendraad | 25 x 1/2"    | 1705025012 |
|                     | 25 x 3/4"    | 1705025034 |
|                     | 25 x 1"      | 1705025100 |
|                     | 32 x 1/2"    | 1705032012 |
|                     | 32 x 3/4"    | 1705032034 |
|                     | 32 x 1"      | 1705032100 |
|                     | 40 x 1"      | 1705040100 |
|                     | 40 x 1 1/4"  | 1705040114 |
|                     | 40 x 1 1/2"  | 1705040112 |
|                     | 50 x 1 1/4"  | 1705050114 |
|                     | 50 x 1 1/2"  | 1705050112 |
|                     | 50 x 2"      | 1705050200 |
|                     | 63 x 1 1/4"  | 1705063114 |
|                     | 63 x 1 1/2"  | 1705063112 |
|                     | 63 x 2"      | 1705063200 |
|                     | 63 x 2 1/2"  | 1705063212 |
|                     | 75 x 1 1/4"  | 1705075114 |
|                     | 75 x 1 1/2"  | 1705075112 |
|                     | 75 x 2"      | 1705075200 |
|                     | 75 x 2 1/2"  | 1705075212 |
|                     | 75 x 3"      | 1705075300 |
|                     | 90 x 2"      | 1705090200 |
|                     | 90 x 2 1/2"  | 1705090212 |
|                     | 90 x 3"      | 1705090300 |
|                     | 90 x 4"      | 1705090400 |
|                     | 110 x 2 1/2" | 1705110212 |
|                     | 110 x 3"     | 1705110300 |
|                     | 110 x 4"     | 1705110400 |
|                     | 125 x 3"     | 1705125300 |
|                     | 125 x 4"     | 1705125400 |
|                     | 125 x 5"     | 1705125500 |
|                     | 160 x 4"     | 1705160400 |
|                     | 160 x 5"     | 1705160500 |
|                     | 160 x 6"     | 1705160600 |
|                     | 200 x 6"     | 1705200600 |
|                     | 200 x 8"     | 1705200800 |

Artikelgroep: 02.02.20



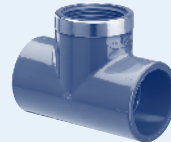
## PVC Drukfittingen met lijm-/draadverbinding

02

|   | Afmeting               | Artikelnr. |
|---|------------------------|------------|
| <b>5052</b><br><b>PVC Knie 90°</b><br>- mof x binnendraad | 16 x 3/8"              | 5052016038 |
|   | 20 x 1/2"              | 5052020012 |
|   | 25 x 3/4"              | 5052025034 |
|   | 32 x 1"                | 5052032100 |
|   | 40 x 1 1/4"            | 5052040114 |
|   | 50 x 1 1/2"            | 5052050112 |
|   | 63 x 2"                | 5052063200 |
|   | 75 x 2 1/2"            | 5052075212 |
|   | 90 x 3"                | 5052090300 |
|   | 110 x 4"               | 5052110400 |
|   | Artikelgroep: 02.02.10 |            |



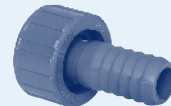
|  | Afmeting         | Artikelnr. |
|--|------------------|------------|
| <b>5742</b><br><b>PVC T-stuk 90°</b><br>- mof x binnendraad<br>x mof<br>- met versterkingsring | 16 x 3/8" x 16   | 5742016038 |
|  | 20 x 1/2" x 20   | 5742020012 |
|  | 25 x 3/4" x 25   | 5742025034 |
|  | 32 x 1" x 32     | 5742032100 |
|  | 40 x 1 1/4" x 40 | 5742040114 |
|  | 50 x 1 1/2" x 50 | 5742050112 |
|  | 63 x 2" x 63     | 5742063200 |
| Artikelgroep: 02.02.10   |                  |            |



|   | Afmeting               | Artikelnr. |
|---|------------------------|------------|
| <b>5752</b><br><b>PVC Knie 90°</b><br>- mof x binnendraad<br>- met versterkingsring | 16 x 3/8"              | 5752016038 |
|   | 20 x 1/2"              | 5752020012 |
|   | 25 x 3/4"              | 5752025034 |
|   | 32 x 1"                | 5752032100 |
|   | 40 x 1 1/4"            | 5752040114 |
|   | 50 x 1 1/2"            | 5752050112 |
|   | 63 x 2"                | 5752063200 |
|   | 75 x 2 1/2"            | 5752075212 |
|   | 90 x 3"                | 5752090300 |
|   | 110 x 4"               | 5752110400 |
|   | Artikelgroep: 02.02.10 |            |



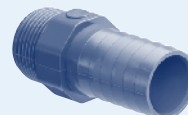
|   | Afmeting    | Artikelnr. |
|---|-------------|------------|
| <b>5362</b><br><b>PVC Slangtule</b><br>- met wartel | 3/4" x 16   | 5362034    |
|   | 1" x 20     | 5362100    |
|   | 1 1/4" x 25 | 5362114    |
|   | 1 1/2" x 30 | 5362112    |
|   | 2" x 40     | 5362200    |
|   | 2 1/4" x 50 | 5362214    |
|   | 2 3/4" x 60 | 5362234    |
| Artikelgroep: 02.02.10                              |             |            |



|   | Afmeting    | Artikelnr. |
|---|-------------|------------|
| <b>5750</b><br><b>PVC Knie 45°</b><br>- mof x binnendraad<br>- met versterkingsring | 20 x 1/2"   | 5750020012 |
|   | 25 x 3/4"   | 5750025034 |
|   | 32 x 1"     | 5750032100 |
|   | 40 x 1 1/4" | 5750040114 |
|   | 50 x 1 1/2" | 5750050112 |
|   | 63 x 2"     | 5750063200 |
| Artikelgroep: 02.02.10  |             |            |



|  | Afmeting    | Artikelnr. |
|--|-------------|------------|
| <b>5361</b><br><b>PVC Slangtule</b><br>- met buitendraad | 1/4" x 12   | 5361014    |
|  | 3/8" x 16   | 5361038    |
|  | 1/2" x 20   | 5361012    |
|  | 3/4" x 25   | 5361034    |
|  | 1" x 30     | 5361100    |
|  | 1 1/4" x 40 | 5361114    |
|  | 1 1/2" x 50 | 5361112    |
|  | 2" x 60     | 5361200    |
| Artikelgroep: 02.02.10                                   |             |            |



|  | Afmeting         | Artikelnr. |
|--|------------------|------------|
| <b>5042</b><br><b>PVC T-stuk 90°</b><br>- mof x binnendraad<br>x mof | 16 x 3/8" x 16   | 5042016038 |
|  | 20 x 1/2" x 20   | 5042020012 |
|  | 25 x 3/4" x 25   | 5042025034 |
|  | 32 x 1/2" x 32   | 5042032012 |
|  | 32 x 1" x 32     | 5042032100 |
|  | 40 x 1/2" x 40   | 5042040012 |
|  | 40 x 3/4" x 40   | 5042040034 |
|  | 40 x 1" x 40     | 5042040100 |
|  | 40 x 1 1/4" x 40 | 5042040114 |
|  | 50 x 1/2" x 50   | 5042050012 |
|  | 50 x 3/4" x 50   | 5042050034 |
|  | 50 x 1" x 50     | 5042050100 |
|  | 50 x 1 1/2" x 50 | 5042050112 |
|  | 63 x 1/2" x 63   | 5042063012 |
|  | 63 x 3/4" x 63   | 5042063034 |
|  | 63 x 1" x 63     | 5042063100 |
|  | 63 x 2" x 63     | 5042063200 |
|  | 75 x 1" x 75     | 5042075100 |
|  | 75 x 2 1/2" x 75 | 5042075212 |
|  | 90 x 3" x 90     | 5042090300 |
|  | 110 x 4" x 110   | 5042110400 |
| Artikelgroep: 02.02.10   |                  |            |



|  | Afmeting         | Artikelnr. |
|--|------------------|------------|
| <b>5359</b><br><b>PVC Slangtule conisch</b><br>- met buitendraad | 1/4" x 12 x 14   | 5359014    |
|  | 3/8" x 16 x 18   | 5359038    |
|  | 1/2" x 20 x 22   | 5359012    |
|  | 3/4" x 25 x 27   | 5359034    |
|  | 1" x 30 x 32     | 5359100    |
|  | 1 1/4" x 40 x 42 | 5359114    |
|  | 1 1/2" x 50 x 52 | 5359112    |
|  | 2" x 60 x 64     | 5359200    |
| Artikelgroep: 02.02.10   |                  |            |



# 02.02 Fittingen voor PVC drukleidingen


## PVC Drukfittingen met lijm-/draadverbinding

02

|                           | Afmeting         | Artikelnr.             |
|---------------------------|------------------|------------------------|
| <b>5363</b>               | 16 lijm          | 536306012016           |
| <b>PVC Slangkoppeling</b> | 1/4" buitendraad | 536306012014           |
| - voor slang              | 3/8" buitendraad | 536306012038           |
| 6 x 12mm                  |                  | Artikelgroep: 02.02.10 |



|                               | Afmeting    | Artikelnr.             |
|-------------------------------|-------------|------------------------|
| <b>5290</b>                   | 16 x 3/8"   | 5290016038             |
| <b>PVC 3-Delige koppeling</b> | 20 x 1/2"   | 5290020012             |
| - mof x buitendraad           | 25 x 3/4"   | 5290025034             |
|                               | 32 x 1"     | 5290032100             |
|                               | 40 x 1 1/4" | 5290040114             |
|                               | 50 x 1 1/2" | 5290050112             |
|                               | 63 x 2"     | 5290063200             |
|                               | 75 x 2 1/2" | 5290075212             |
|                               | 90 x 3"     | 5290090300             |
|                               | 110 x 4"    | 5290110400             |
|                               |             | Artikelgroep: 02.02.10 |



|                         | Afmeting         | Artikelnr.             |
|-------------------------|------------------|------------------------|
| <b>5880</b>             | 16 x 16 x 1/2"   | 5880016                |
| <b>PVC Tankdoorvoer</b> | 20 x 20 x 3/4"   | 5880020                |
| - wordt zonder          | 25 x 25 x 1"     | 5880025                |
| pakkingen               | 32 x 32 x 1 1/4" | 5880032                |
| geleverd                | 40 x 40 x 1 1/2" | 5880040                |
|                         | 50 x 50 x 2"     | 5880050                |
|                         | 63 x 63 x 2 1/2" | 5880063                |
|                         | 75 x 75 x 3"     | 5880075                |
|                         | 90 x 90 x 4"     | 5880090                |
|                         | 125 x 110 x 4" * | 5880125                |
|                         |                  | Artikelgroep: 02.02.10 |



\* Inclusief pakkingen.  
Voor moeren en pakkingen, zie blz. 88.

|                           | Afmeting    | Artikelnr.             |
|---------------------------|-------------|------------------------|
| <b>5289</b>               | 20 x 1/2"   | 5289020012             |
| <b>3-Delige koppeling</b> | 25 x 3/4"   | 5289025034             |
| - PVC x gietijzer         | 32 x 1"     | 5289032100             |
| - mof x binnendraad       | 40 x 1 1/4" | 5289040114             |
|                           | 50 x 1 1/2" | 5289050112             |
|                           | 63 x 2"     | 5289063200             |
|                           | 75 x 2 1/2" | 5289075212             |
|                           | 90 x 3"     | 5289090300             |
|                           |             | Artikelgroep: 02.02.10 |




|                               | Afmeting    | Artikelnr.             |
|-------------------------------|-------------|------------------------|
| <b>5082</b>                   | 16 x 3/8"   | 5082016038             |
| <b>PVC 3-Delige koppeling</b> | 20 x 1/2"   | 5082020012             |
| - met EPDM                    | 25 x 3/4"   | 5082025034             |
| O-ringen                      | 32 x 1"     | 5082032100             |
| - mof x binnendraad           | 40 x 1 1/4" | 5082040114             |
|                               | 50 x 1 1/2" | 5082050112             |
|                               | 63 x 2"     | 5082063200             |
|                               | 75 x 2 1/2" | 5082075212             |
|                               | 90 x 3"     | 5082090300             |
|                               | 110 x 4"    | 5082110400             |
|                               |             | Artikelgroep: 02.02.10 |



|                           | Afmeting    | Artikelnr.             |
|---------------------------|-------------|------------------------|
| <b>5288</b>               | 20 x 1/2"   | 5288020012             |
| <b>3-Delige koppeling</b> | 25 x 3/4"   | 5288025034             |
| - PVC x gietijzer         | 32 x 1"     | 5288032100             |
| - mof x buitendraad       | 40 x 1 1/4" | 5288040114             |
|                           | 50 x 1 1/2" | 5288050112             |
|                           | 63 x 2"     | 5288063200             |
|                           |             | Artikelgroep: 02.02.10 |



|                               | Afmeting    | Artikelnr.             |
|-------------------------------|-------------|------------------------|
| <b>5083</b>                   | 25 x 3/4"   | 5083025034             |
| <b>PVC 2-Delige koppeling</b> | 32 x 1"     | 5083032100             |
| - mof x buitendraad           | 40 x 1 1/4" | 5083040114             |
|                               | 50 x 1 1/2" | 5083050112             |
|                               | 63 x 2"     | 5083063200             |
|                               |             | Artikelgroep: 02.02.10 |



|                           | Afmeting    | Artikelnr.             |
|---------------------------|-------------|------------------------|
| <b>5291</b>               | 16 x 3/8"   | 5291016038             |
| <b>3-Delige koppeling</b> | 20 x 1/2"   | 5291020012             |
| - PVC x messing           | 25 x 3/4"   | 5291025034             |
| - mof x binnendraad       | 32 x 1"     | 5291032100             |
|                           | 40 x 1 1/4" | 5291040114             |
|                           | 50 x 1 1/2" | 5291050112             |
|                           | 63 x 2"     | 5291063200             |
|                           | 75 x 2 1/2" | 5291075212             |
|                           | 90 x 3"     | 5291090300             |
|                           |             | Artikelgroep: 02.02.10 |



## PVC Drukfittingen met lijm-/draadverbinding

|                           | Afmeting              | Artikelnr. |
|---------------------------|-----------------------|------------|
| <b>5292</b>               | 16 x $\frac{3}{8}$ "  | 5292016038 |
| <b>3-Delige koppeling</b> | 20 x $\frac{1}{2}$ "  | 5292020012 |
| - PVC x messing           | 25 x $\frac{3}{4}$ "  | 5292025034 |
| - mof x buitendraad       | 32 x 1"               | 5292032100 |
|                           | 40 x $1\frac{1}{4}$ " | 5292040114 |
|                           | 50 x $1\frac{1}{2}$ " | 5292050112 |
|                           | 63 x 2"               | 5292063200 |
|                           | 75 x $2\frac{1}{2}$ " | 5292075212 |
|                           | 90 x 3"               | 5292090300 |



Artikelgroep: 02.02.10

|                           | Afmeting              | Artikelnr. |
|---------------------------|-----------------------|------------|
| <b>5294</b>               | 20 x $\frac{1}{2}$ "  | 5294020012 |
| <b>3-Delige koppeling</b> | 25 x $\frac{3}{4}$ "  | 5294025034 |
| - PVC x RVS               | 32 x 1"               | 5294032100 |
| - mof x buitendraad       | 40 x $1\frac{1}{4}$ " | 5294040114 |
|                           | 50 x $1\frac{1}{2}$ " | 5294050112 |
|                           | 63 x 2"               | 5294063200 |
|                           | 75 x $2\frac{1}{2}$ " | 5294075212 |
|                           | 90 x 3"               | 5294090300 |
|                           | 110 x 4"              | 5294110400 |



Artikelgroep: 02.02.10

|                           | Afmeting              | Artikelnr. |
|---------------------------|-----------------------|------------|
| <b>5293</b>               | 20 x $\frac{1}{2}$ "  | 5293020012 |
| <b>3-Delige koppeling</b> | 25 x $\frac{3}{4}$ "  | 5293025034 |
| - PVC x RVS               | 32 x 1"               | 5293032100 |
| - mof x binnendraad       | 40 x $1\frac{1}{4}$ " | 5293040114 |
|                           | 50 x $1\frac{1}{2}$ " | 5293050112 |
|                           | 63 x 2"               | 5293063200 |
|                           | 75 x $2\frac{1}{2}$ " | 5293075212 |
|                           | 90 x 3"               | 5293090300 |
|                           | 110 x 4"              | 5293110400 |



Artikelgroep: 02.02.10

02

# 02.02 Fittingen voor PVC drukleidingen

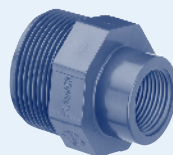
## PVC Drukfittingen met draadverbinding

02

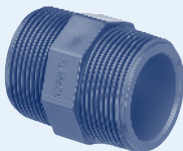
|   | Afmeting | Artikelnr. |
|---|----------|------------|
| <b>5011</b><br><b>PVC Draadsok</b><br>- 2 x binnendraad | 3/8"     | 5011038    |
|   | 1/2"     | 5011012    |
|   | 3/4"     | 5011034    |
|   | 1"       | 5011100    |
|   | 1 1/4"   | 5011114    |
|   | 1 1/2"   | 5011112    |
|   | 2"       | 5011200    |
|   | 2 1/2"   | 5011212    |
|   | 3"       | 5011300    |
|   | 4"       | 5011400    |
| Artikelgroep: 02.02.10                                  |          |            |



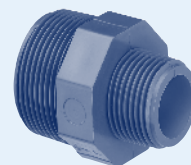
|  | Afmeting        | Artikelnr. |
|--|-----------------|------------|
| <b>5021</b><br><b>PVC Draad-<br/>verloopstuk</b><br>- buitendraad x<br>binnendraad | 1/2" x 3/8"     | 5021012038 |
|  | 3/4" x 3/8"     | 5021034038 |
|  | 3/4" x 1/2"     | 5021034012 |
|  | 1" x 1/2"       | 5021100012 |
|  | 1" x 3/4"       | 5021100034 |
|  | 1 1/4" x 1/2"   | 5021114012 |
|  | 1 1/4" x 3/4"   | 5021114034 |
|  | 1 1/4" x 1"     | 5021114100 |
|  | 1 1/2" x 3/4"   | 5021112034 |
|  | 1 1/2" x 1"     | 5021112100 |
|  | 1 1/2" x 1 1/4" | 5021112114 |
|  | 2" x 1"         | 5021200100 |
|  | 2" x 1 1/4"     | 5021200114 |
|  | 2" x 1 1/2"     | 5021200112 |
|  | 2 1/2" x 2"     | 5021212200 |
|  | 3" x 2"         | 5021300200 |
| 3" x 2 1/2"  | 5021300212      |            |
| 4" x 3"  | 5021400300      |            |
| Artikelgroep: 02.02.10   |                 |            |



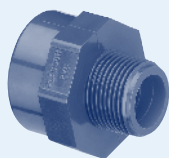
|   | Afmeting | Artikelnr. |
|---|----------|------------|
| <b>5061</b><br><b>PVC Dubbele<br/>nippel</b><br>- 2 x buitendraad | 3/8"     | 5061038    |
|   | 1/2"     | 5061012    |
|   | 3/4"     | 5061034    |
|   | 1"       | 5061100    |
|   | 1 1/4"   | 5061114    |
|   | 1 1/2"   | 5061112    |
|   | 2"       | 5061200    |
|   | 2 1/2"   | 5061212    |
|   | 3"       | 5061300    |
|   | 4"       | 5061400    |
| Artikelgroep: 02.02.10  |          |            |



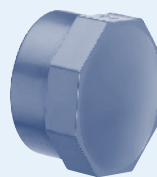
|   | Afmeting        | Artikelnr. |
|---|-----------------|------------|
| <b>5161</b><br><b>PVC Draad-<br/>verloopnippel</b><br>- 2 x buitendraad | 1/2" x 3/8"     | 5161012038 |
|   | 3/4" x 3/8"     | 5161034038 |
|   | 3/4" x 1/2"     | 5161034012 |
|   | 1" x 1/2"       | 5161100012 |
|   | 1" x 3/4"       | 5161100034 |
|   | 1 1/4" x 3/4"   | 5161114034 |
|   | 1 1/4" x 1"     | 5161114100 |
|   | 1 1/2" x 1"     | 5161112100 |
|   | 1 1/2" x 1 1/4" | 5161112114 |
|   | 2" x 1 1/4"     | 5161200114 |
|   | 2" x 1 1/2"     | 5161200112 |
|   | 2 1/2" x 1 1/2" | 5161212112 |
|   | 2 1/2" x 2"     | 5161212200 |
|   | 3" x 2"         | 5161300200 |
|   | 3" x 2 1/2"     | 5161300212 |
|   | 4" x 2 1/2"     | 5161400212 |
| 4" x 3"   | 5161400300      |            |
| Artikelgroep: 02.02.10  |                 |            |



|   | Afmeting        | Artikelnr. |
|---|-----------------|------------|
| <b>5221</b><br><b>PVC Soknippel</b><br>- binnendraad x<br>buitendraad | 1/2" x 3/8"     | 5221012038 |
|   | 3/4" x 1/2"     | 5221034012 |
|   | 1" x 3/4"       | 5221100034 |
|   | 1 1/4" x 1"     | 5221114100 |
|   | 1 1/2" x 1 1/4" | 5221112114 |
|   | 2" x 1 1/2"     | 5221200112 |
|   | 2 1/2" x 1 1/2" | 5221212112 |
|   | 2 1/2" x 2"     | 5221212200 |
|   | 3" x 2"         | 5221300200 |
|   | 3" x 2 1/2"     | 5221300212 |
|   | 4" x 2 1/2"     | 5221400212 |
| 4" x 3"   | 5221400300      |            |
| Artikelgroep: 02.02.10  |                 |            |




|   | Afmeting | Artikelnr. |
|---|----------|------------|
| <b>5071</b><br><b>PVC Afsluitkap</b><br>- met binnendraad | 3/8"     | 5071038    |
|   | 1/2"     | 5071012    |
|   | 3/4"     | 5071034    |
|   | 1"       | 5071100    |
|   | 1 1/4"   | 5071114    |
|   | 1 1/2"   | 5071112    |
|   | 2"       | 5071200    |
|   | 2 1/2"   | 5071212    |
|   | 3"       | 5071300    |
| 4"  | 5071400  |            |
| Artikelgroep: 02.02.10                                    |          |            |



## PVC Drukfittingen met draadverbinding

02

|  | Afmeting | Artikelnr. |
|--|----------|------------|
| <b>5051</b><br><b>PVC Draadknie 90°</b><br>- 2 x binnendraad | 3/8"     | 5051038    |
|  | 1/2"     | 5051012    |
|  | 3/4"     | 5051034    |
|  | 1"       | 5051100    |
|  | 1 1/4"   | 5051114    |
|  | 1 1/2"   | 5051112    |
|  | 2"       | 5051200    |
|  | 2 1/2"   | 5051212    |
|  | 3"       | 5051300    |
|  | 4"       | 5051400    |
|  |          |            |



|  | Afmeting | Artikelnr.             |
|--|----------|------------------------|
| <b>5081</b><br><b>PVC 3-Delige koppeling</b><br>- met EPDM O-ringen<br>- 2 x binnendraad | 3/8"     | 5081038                |
|  | 1/2"     | 5081012                |
|  | 3/4"     | 5081034                |
|  | 1"       | 5081100                |
|  | 1 1/4"   | 5081114                |
|  | 1 1/2"   | 5081112                |
|  | 2"       | 5081200                |
|  |          | Artikelgroep: 02.02.10 |



|  | Afmeting | Artikelnr. |
|--|----------|------------|
| <b>5171</b><br><b>PVC Afsluitplug</b><br>- met buitendraad | 3/8"     | 5171038    |
|  | 1/2"     | 5171012    |
|  | 3/4"     | 5171034    |
|  | 1"       | 5171100    |
|  | 1 1/4"   | 5171114    |
|  | 1 1/2"   | 5171112    |
|  | 2"       | 5171200    |
|  | 2 1/2"   | 5171212    |
|  | 3"       | 5171300    |
|  | 4"       | 5171400    |
|  |          |            |



|   | Afmeting | Artikelnr.             |
|---|----------|------------------------|
| <b>5921</b><br><b>PVC Flens met kraagbus</b><br>- met binnendraad | 1"       | 5921100                |
|   | 1 1/4"   | 5921114                |
|   | 1 1/2"   | 5921112                |
|   | 2"       | 5921200                |
|   | 2 1/2"   | 5921212                |
|   | 3"       | 5921300                |
|   | 4"       | 5921400                |
|   |          | Artikelgroep: 02.02.10 |



|   | Afmeting | Artikelnr. |
|---|----------|------------|
| <b>5041</b><br><b>PVC Draad T-stuk 90°</b><br>- 3 x binnendraad | 3/8"     | 5041038    |
|   | 1/2"     | 5041012    |
|   | 3/4"     | 5041034    |
|   | 1"       | 5041100    |
|   | 1 1/4"   | 5041114    |
|   | 1 1/2"   | 5041112    |
|   | 2"       | 5041200    |
|   | 2 1/2"   | 5041212    |
|   | 3"       | 5041300    |
|   | 4"       | 5041400    |
|   |          |            |





# 02.02 Fittingen voor PVC drukleidingen

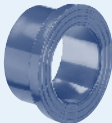
## PVC Fittingen onderdelen

02

|   | Afmeting | Artikelnr.             |
|---|----------|------------------------|
| <b>5885</b><br><b>PVC Moer</b><br>- met binnendraad<br>- o.a. voor tank-<br>doorvoer 5880 | 1/2"     | 5885012                |
|   | 3/4"     | 5885034                |
|   | 1"       | 5885100                |
|   | 1 1/4"   | 5885114                |
|   | 1 1/2"   | 5885112                |
|   | 2"       | 5885200                |
|   | 2 1/2"   | 5885212                |
|   | 3"       | 5885300                |
|   | 4"       | 5885400                |
|          |          | Artikelgroep: 02.02.15 |

|   | Afmeting in mm | Artikelnr.             |
|---|----------------|------------------------|
| <b>5580</b><br><b>PVC Schroefdeel</b><br>- voor 5080                              | 16             | 5580016                |
|   | 20             | 5580020                |
|   | 25             | 5580025                |
|   | 32             | 5580032                |
|   | 40             | 5580040                |
|   | 50             | 5580050                |
|   | 63             | 5580063                |
|  |                | Artikelgroep: 02.02.15 |


|   | Afmeting in mm   | Artikelnr. |
|---|--|------------|
| <b>5629</b><br><b>EPDM Pakking</b><br>- voor tankdoorvoer<br>5880 | 20 (voor tankdoorvoer 16)  | 5629020    |
|   | 25 (voor tankdoorvoer 20)  | 5629025    |
|   | 32 (voor tankdoorvoer 25)  | 5629032    |
|   | 40 (voor tankdoorvoer 32)  | 5629040    |
|   | 50 (voor tankdoorvoer 40)  | 5629050    |
|   | 63 (voor tankdoorvoer 50)  | 5629063    |
|   | 75 (voor tankdoorvoer 63)  | 5629075    |
|   | 90 (voor tankdoorvoer 75)  | 5629090    |
|   | 110 (voor tankdoorvoer 90)   | 5629110    |
|   |  |            |

|  | Afmeting in mm | Artikelnr.             |
|--|----------------|------------------------|
| <b>5680</b><br><b>PVC Kraagbus</b><br>(inlegstuk)<br>- voor 5080, 5082<br>en 5289  | 16             | 5680016                |
|  | 20             | 5680020                |
|  | 25             | 5680025                |
|  | 32             | 5680032                |
|  | 40             | 5680040                |
|  | 50             | 5680050                |
|  | 63             | 5680063                |
|  |                | Artikelgroep: 02.02.15 |


|  | Afmeting in mm  | Artikelnr. |
|--|---|------------|
| <b>5630</b><br><b>FPM (viton) Pakking</b><br>- voor tankdoorvoer<br>5880 | 20 (voor tankdoorvoer 16)   | 5630020    |
|  | 25 (voor tankdoorvoer 20)   | 5630025    |
|  | 32 (voor tankdoorvoer 25)   | 5630032    |
|  | 40 (voor tankdoorvoer 32)   | 5630040    |
|  | 50 (voor tankdoorvoer 40)   | 5630050    |
|  | 63 (voor tankdoorvoer 50)   | 5630063    |
|  | 75 (voor tankdoorvoer 63)   | 5630075    |
|  | 90 (voor tankdoorvoer 75)   | 5630090    |
|  | 110 (voor tankdoorvoer 90)  | 5630110    |
|  |  |            |


|   | Afmeting  | Artikelnr. |
|---|---|------------|
| <b>5681</b><br><b>PVC Draad-<br/>                     kraagbus</b><br>- voor 5081 | 3/8"  | 5681038    |
|   | 1/2"  | 5681012    |
|   | 3/4"  | 5681034    |
|   | 1"  | 5681100    |
|   | 1 1/4"  | 5681114    |
|   | 1 1/2"  | 5681112    |
|   | 2"  | 5681200    |
|   |  |            |

|   | Afmeting in mm | Artikelnr.             |
|---|----------------|------------------------|
| <b>5480</b><br><b>PVC Wartelmoer</b><br>- voor 5080, 5081,<br>5082 en 5362          | 16             | 5480016                |
|   | 20             | 5480020                |
|   | 25             | 5480025                |
|   | 32             | 5480032                |
|   | 40             | 5480040                |
|   | 50             | 5480050                |
|   | 63             | 5480063                |
|  |                | Artikelgroep: 02.02.15 |

|   | Afmeting in mm | Artikelnr.             |
|---|----------------|------------------------|
| <b>5639</b><br><b>EPDM O-ring</b><br>- voor 5080, 5081<br>en 5083                   | 16             | 5639016                |
|   | 20             | 5639020                |
|   | 25             | 5639025                |
|   | 32             | 5639032                |
|   | 40             | 5639040                |
|   | 50             | 5639050                |
|   | 63             | 5639063                |
|   | 75             | 5639075                |
|   | 90             | 5639090                |
|   | 110            | 5639110                |
|  |                | Artikelgroep: 02.02.15 |

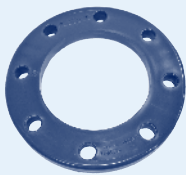
## PVC Fittingen onderdelen

|   | Afmeting in mm | Artikelnr.             |
|---|----------------|------------------------|
| <b>5640</b><br>FPM (viton) O-ring<br>- voor 5980<br> | 16             | 5640016                |
|   | 20             | 5640020                |
|   | 25             | 5640025                |
|   | 32             | 5640032                |
|   | 40             | 5640040                |
|   | 50             | 5640050                |
|   | 63             | 5640063                |
|   |                | Artikelgroep: 02.02.15 |

| Artikelnr.   | Afmeting    | Artikelnr.             |
|--|-------------|------------------------|
| <b>5669</b><br>Vlakke ring<br>- voor 5289<br> | 20 x 1/2"   | 5669020012             |
|  | 25 x 3/4"   | 5669025034             |
|  | 32 x 1"     | 5669032100             |
|  | 40 x 1 1/4" | 5669040114             |
|  | 50 x 1 1/2" | 5669050112             |
|  | 63 x 2"     | 5669063200             |
|  |             | Artikelgroep: 02.02.15 |

02

## PVC Flenzen voor PVC leidingen

|   | Afmeting in mm | Geboord/drukklass PN | øk in mm | Ød6 in mm | b in mm | n x ød2 in mm | Artikelnr.           |
|---|----------------|----------------------|----------|-----------|---------|---------------|----------------------|
| <b>5900</b><br>PVC Overschuifflens<br> | 16             | 16                   | 60       | 23        | 10      | 4 x 14        | 5900016              |
|   | 20             | 16                   | 65       | 27        | 11      | 4 x 14        | 5900020              |
|   | 25             | 16                   | 75       | 34        | 12      | 4 x 14        | 5900025              |
|   | 32             | 16                   | 85       | 44        | 14      | 4 x 14        | 5900032              |
|   | 40             | 16                   | 100      | 54        | 15      | 4 x 18        | 5900040              |
|   | 50             | 16                   | 110      | 65        | 16      | 4 x 18        | 5900050              |
|   | 63             | 16                   | 125      | 80        | 18      | 4 x 18        | 5900063              |
|   | 75             | 16                   | 145      | 94        | 19      | 4 x 18        | 5900075              |
|   | 90             | 16                   | 160      | 112       | 20      | 8 x 18        | 5900090              |
|   | 110            | 16                   | 180      | 135       | 22      | 8 x 18        | 5900110              |
|   | 125            | 16                   | 191      | 151       | 25      | 8 x 18        | 5900125              |
|   | 140            | 16                   | 211      | 168       | 28      | 8 x 18        | 5900140              |
|   | 160            | 16                   | 241      | 193       | 30      | 8 x 22        | 5900160              |
|   | 180            | 10                   | 270      | 200       | 32      | 8 x 22        | 5900180              |
|   | 200            | 10                   | 297      | 255       | 32      | 8 x 22        | 5900200              |
|   | 225            | 10                   | 300      | 250       | 33      | 8 x 22        | 5900225              |
|   | 250            | 10                   | 350      | 285       | 32      | 12 x 22       | 5900250              |
|   | 280            | 10                   | 350      | 305       | 32      | 12 x 22       | 5900280              |
|   | 315            | 10                   | 400      | 345       | 35      | 12 x 22       | 5900315              |
|   | 355            | 10                   | 460      | 386       | 30      | 16 x 22       | 5900355              |
| 400   | 10             | 515                  | 440      | 32        | 16 x 22 | 5900400       |                      |
| 500   | 6              | 620                  | 530      | 35        | 20 x 24 | 5900500       |                      |
|   |                |                      |          |           |         |               | Artikelgr.: 02.02.05 |

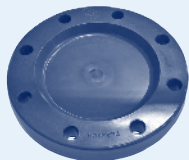
øk = steekcirkel  
 ød6 = binnenmaat  
 b = dikte flens  
 n = aantal gaten  
 ød2 = diameter gat

## 02.02 Fittingen voor PVC drukleidingen

### PVC Flenzen voor PVC leidingen

02

#### 5911 PVC Blindflens



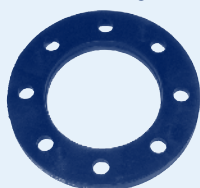
| Afmeting<br>in mm | Geboord/drukklasse<br>PN | øk<br>in mm | b<br>in mm | n x ød2<br>in mm | Artikelnr. |
|-------------------|--------------------------|-------------|------------|------------------|------------|
| 20                | 16                       | 65          | 11         | 4 x 14           | 5911020    |
| 25                | 16                       | 75          | 12         | 4 x 14           | 5911025    |
| 32                | 16                       | 85          | 14         | 4 x 14           | 5911032    |
| 40                | 16                       | 100         | 15         | 4 x 18           | 5911040    |
| 50                | 16                       | 110         | 16         | 4 x 18           | 5911050    |
| 63                | 16                       | 125         | 18         | 4 x 18           | 5911063    |
| 75                | 16                       | 145         | 19         | 4 x 18           | 5911075    |
| 90                | 16                       | 160         | 20         | 8 x 18           | 5911090    |
| 110               | 16                       | 180         | 22         | 8 x 18           | 5911110    |
| 125               | 16                       | 191         | 25         | 8 x 18           | 5911125    |
| 140               | 16                       | 211         | 28         | 8 x 18           | 5911140    |
| 160               | 16                       | 241         | 30         | 8 x 22           | 5911160    |
| 200               | 10                       | 297         | 32         | 8 x 22           | 5911200    |
| 225               | 10                       | 300         | 33         | 8 x 22           | 5911225    |
| 250/280           | 10                       | 350         | 33         | 12 x 22          | 5911250    |
| 315               | 10                       | 400         | 35         | 12 x 22          | 5911315    |
| 400               | 10                       | 515         | 32         | 16 x 22          | 5911400    |

Artikelgr.: 02.02.05

øk = steekcirkel  
b = dikte flens  
n = aantal gaten  
ød2 = diameter gat

### PP Flenzen voor PVC leidingen

#### 5903 PP Overschuifflens - met stalen kern - voor PVC kraagbus



| Afmeting<br>in mm | Geboord/drukklasse<br>PN | øk<br>in mm | ød6<br>in mm | b<br>in mm | n x ød2<br>in mm | Artikelnr. |
|-------------------|--------------------------|-------------|--------------|------------|------------------|------------|
| 20                | 10/16                    | 65          | 28           | 12         | 4 x 14           | 5903020    |
| 25                | 10/16                    | 75          | 34           | 14         | 4 x 14           | 5903025    |
| 32                | 10/16                    | 85          | 42           | 14         | 4 x 14           | 5903032    |
| 40                | 10/16                    | 100         | 51           | 16         | 4 x 18           | 5903040    |
| 50                | 10/16                    | 110         | 62           | 18         | 4 x 18           | 5903050    |
| 63                | 10/16                    | 125         | 78           | 18         | 4 x 18           | 5903063    |
| 75                | 10/16                    | 145         | 92           | 18         | 4 x 18           | 5903075    |
| 90                | 10/16                    | 160         | 108          | 18         | 8 x 18           | 5903090    |
| 110               | 10/16                    | 180         | 128          | 18         | 8 x 18           | 5903110    |
| 140               | 10/16                    | 210         | 167          | 25         | 8 x 18           | 59031401   |
| 160               | 10/16                    | 240         | 190          | 28         | 8 x 22           | 59031601   |
| 200               | 10                       | 295         | 235          | 24         | 8 x 22           | 5903200    |
| 200               | 16                       | 295         | 235          | 24         | 12 x 22          | 590320016  |
| 225               | 10                       | 295         | 250          | 31         | 8 x 22           | 59032251   |
| 250               | 10                       | 350         | 288          | 31         | 12 x 22          | 5903250    |
| 250               | 16                       | 355         | 288          | 30         | 12 x 26          | 590325016  |
| 315               | 10                       | 400         | 348          | 37         | 12 x 22          | 59033151   |

Artikelgr.: 01.02.50

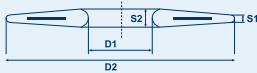
øk = steekcirkel  
ød6 = binnenmaat  
b = dikte flens  
n = aantal gaten  
ød2 = diameter gat

Voor afwijkende uitvoeringen of diameters kunt u contact opnemen met onze verkoopmedewerkers.

## PSI Pakkingen, afdichtingen en Petro-band

02

**Fig. 192**  
EPDM Pakking  
met staalinlage  
- voor water

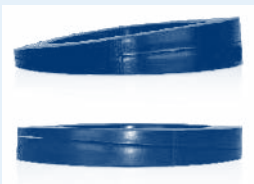


| Afmeting | Drukklasse | D1xD2 / S1xS2<br>in mm | Geschikt voor                     | Artikelnr. |
|----------|------------|------------------------|-----------------------------------|------------|
| DN15     | PN10/40    | 22 x 51 / 3-4          | 20mm PE/PVC/staal                 | 100802462  |
| DN20     | PN10/40    | 27 x 61 / 3-4          | 25mm PE/PVC/staal                 | 100803463  |
| DN25     | PN10/40    | 34 x 71 / 3-4          | 32mm PE/PVC/staal                 | 100801464  |
| DN32     | PN10/40    | 43 x 82 / 3-4          | 40mm PE/PVC/staal                 | 100803418  |
| DN40     | PN10/40    | 49 x 92 / 3-4          | 50mm PE/PVC/staal                 | 100803439  |
| DN50     | PN10/40    | 61 x 107 / 4-5         | 63mm PE/PVC/staal                 | 100803462  |
| DN65     | PN10/40    | 77 x 127 / 4-5         | 75mm PE/PVC/staal                 | 100803483  |
| DN80     | PN10/40    | 89 x 142 / 3-4         | 90mm PE/PVC/staal                 | 100801465  |
| DN100    | PN10/16    | 115 x 162 / 4-5        | 110mm PE/PVC/staal                | 100801466  |
| DN100    | PN25/40    | 115 x 168 / 5-6        | 125mm PE/staal                    | 100801488  |
| DN125    | PN10/16    | 141 x 192 / 4-5        | 140mm PE/PVC/staal                | 100803491  |
| DN150    | PN10/16    | 169 x 218 / 4-5        | 160mm PE/PVC/staal-180mm PE/Staal | 100803495  |
| DN200    | PN10/16    | 220 x 273 / 5-6        | 200mm / 225mm PE/PVC/staal        | 100803499  |
| DN250    | PN10       | 273 x 328 / 5-6        | 250mm / 280mm PE/PVC/staal        | 100803504  |
| DN250    | PN16       | 273 x 329 / 6-7        | 250mm / 280mm PE/PVC/staal        | 100803505  |
| DN300    | PN10       | 324 x 378 / 5-6        | 315mm PE/PVC/staal                | 100803510  |
| DN300    | PN16       | 324 x 384 / 6-7        | 315mm PE/staal                    | 100803511  |
| DN350    | PN10       | 356 x 438 / 6-7        | 355mm PVC                         | 100803515  |
| DN350    | PN16       | 368 x 445 / 7-9        | 355mm PE/staal                    | 100801516  |
| DN400    | PN10       | 407 x 489 / 6-7        | 400mm PE/PVC/staal                | 100903520  |
| DN400    | PN16       | 407 x 495 / 7-9        | 400mm PE/staal                    | 100903521  |
| DN450    | PN10       | 470 x 540 / 7-9        | 450mm PE/staal                    | 100903525  |
| DN450    | PN16       | 470 x 557 / 7-9        | 450mm PE/staal                    | 100901526  |
| DN500    | PN10       | 508 x 594 / 6-7        | 450mm / 500mm PE/staal            | 100901474  |
| DN500    | PN16       | 508 x 617 / 7-9        | 450mm / 500mm PE/staal            | 100903532  |
| DN600    | PN10       | 610 x 695 / 6-7        | 630mm PE/staal                    | 100901475  |
| DN700    | PN10       | 712 x 810 / 7-8        | 710mm PE/staal                    | 100901476  |
| DN800    | PN10       | 813 x 917 / 7-8        | 800mm PE/staal                    | 100901477  |
| DN900    | PN10       | 915 x 1017/7-8         | 900mm PE                          | 100901548  |
| DN1000   | PN10       | 1016 x 1124/7-8        | 1000mm PE                         | 100901479  |

Artikelgroep: 16.02.05

PN6 flenzen zijn op aanvraag leverbaar.

**Fig. 195**  
EPDM Pakking  
- verstelbaar tot 8°



| DN  | Drukklasse | Dikte in mm<br>(min x max) | Maat bout x<br>lengte in mm | Artikelnr. |
|-----|------------|----------------------------|-----------------------------|------------|
| 32  | PN10/40    | 9 x 20                     | M14 x 90                    | 100804001  |
| 40  | PN10/40    | 9 x 22                     | M14 x 90                    | 100804002  |
| 50  | PN10/40    | 9 x 24                     | M14 x 100                   | 100804003  |
| 65  | PN10/40    | 9 x 26                     | M14 x 100                   | 100804004  |
| 80  | PN10/40    | 14 x 30                    | M14 x 100                   | 100804005  |
| 100 | PN10/16    | 14 x 30                    | M14 x 100                   | 100804006  |
| 100 | PN25/40    | 14 x 33                    | M18 x 110                   | 100804007  |
| 125 | PN10/16    | 14 x 36                    | M14 x 100                   | 100804110  |
| 150 | PN10/16    | 14 x 39                    | M18 x 110                   | 100804008  |
| 150 | PN25/40    | 14 x 39                    | M22 x 130                   | 100804009  |
| 200 | PN10/16    | 15 x 50                    | M18 x 120                   | 100804010  |
| 200 | PN40       | 15 x 50                    | M24 x 160                   | 100804011  |
| 250 | PN10/16    | 16 x 59                    | M18 x 140                   | 100804012  |
| 250 | PN40       | 16 x 59                    | M27 x 170                   | 100804013  |
| 300 | PN10       | 22 x 68                    | M18 x 150                   | 100804014  |
| 350 | PN10       | 22 x 68                    | M18 x 150                   | 100804015  |
| 400 | PN10       | 22 x 74                    | M22 x 160                   | 100804016  |
| 500 | PN10       | 23 x 79                    | M22 x 180                   | 100804017  |

Artikelgroep: 16.02.05

# 02.02 Fittingen voor PVC drukleidingen

## PSI Pakkingen, afdichtingen en Petro-band

02

**Fig. 205**  
NBR Pakking  
met staalinlage  
- voor water

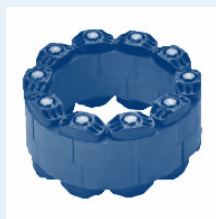


| Afmeting | Drukklasse | D1xD2 / S1xS2<br>in mm | Geschikt voor                     | Artikelnr. |
|----------|------------|------------------------|-----------------------------------|------------|
| DN15     | PN10/40    | 22 x 51 / 3-4          | 20mm PE/PVC/staal                 | 100801287  |
| DN20     | PN10/40    | 27 x 61 / 3-4          | 25mm PE/PVC/staal                 | 100801288  |
| DN25     | PN10/40    | 34 x 71 / 3-4          | 32mm PE/PVC/staal                 | 100801289  |
| DN32     | PN10/40    | 43 x 82 / 3-4          | 40mm PE/PVC/staal                 | 100903242  |
| DN40     | PN10/40    | 49 x 92 / 3-4          | 50mm PE/PVC/staal                 | 100803263  |
| DN50     | PN10/40    | 61 x 107 / 4-5         | 63mm PE/PVC/staal                 | 100803286  |
| DN65     | PN10/40    | 77 x 127 / 4-5         | 75mm PE/PVC/staal                 | 100803308  |
| DN80     | PN10/40    | 89 x 142 / 3-4         | 90mm PE/PVC/staal                 | 100803309  |
| DN100    | PN10/16    | 115 x 162 / 4-5        | 110mm PE/PVC/staal                | 100803312  |
| DN100    | PN25/40    | 115 x 168 / 5-6        | 125mm PE                          | 100803313  |
| DN125    | PN10/16    | 141 x 192 / 4-5        | 140mm PE/PVC/staal                | 100803316  |
| DN150    | PN10/16    | 169 x 218 / 4-5        | 160mm PE/PVC/staal-180mm PE/staal | 100803320  |
| DN200    | PN10/16    | 220 x 273 / 5-6        | 200mm / 225mm PE/PVC/staal        | 100803324  |
| DN250    | PN10       | 273 x 328 / 5-6        | 250mm / 280mm PE/PVC/staal        | 100803329  |
| DN250    | PN16       | 273 x 329 / 6-7        | 250mm / 280mm PE/PVC/staal        | 100803330  |
| DN300    | PN10       | 324 x 378 / 5-6        | 315mm PE/PVC/staal                | 100803335  |
| DN300    | PN16       | 324 x 384 / 6-7        | 315mm PE/staal                    | 100803336  |
| DN350    | PN10       | 356 x 438 / 6-7        | 355mm PVC                         | 100801297  |
| DN350    | PN16       | 368 x 445 / 7-9        | 355mm PE                          | 100801341  |
| DN400    | PN10       | 407 x 489 / 6-7        | 400mm PE/PVC/staal                | 100903345  |
| DN400    | PN16       | 407 x 495 / 7-9        | 400mm PE/staal                    | 100903346  |
| DN450    | PN10       | 470 x 540 / 7-9        | 450mm PE                          | 100903350  |
| DN450    | PN16       | 470 x 557 / 7-9        | 450mm PE                          | 100901351  |
| DN500    | PN10       | 508 x 594 / 6-7        | 450mm / 500mm PE/staal            | 100903356  |
| DN500    | PN16       | 508 x 617 / 7-9        | 450mm / 500mm PE/staal            | 100903358  |
| DN600    | PN10       | 610 x 695 / 6-7        | 630mm PE/staal                    | 100903362  |
| DN700    | PN10       | 712 x 810 / 7-8        | 710mm PE/staal                    | 100903366  |
| DN800    | PN10       | 813 x 917 / 7-8        | 800mm PE                          | 100901302  |
| DN900    | PN10       | 915 x 1017 / 7-8       | 900mm PE                          | 100901374  |
| DN1000   | PN10       | 1016 x 1124 / 7-8      | 1000mm PE                         | 100901304  |

Artikelgroep: 16.02.05

**Fig. 220**  
Link-Seal afsluitschakel

- alle metalen delen RVS316
- EPDM rubber (zwart)\* (standaard)
- NBR rubber (groen)



| Type         | Bereik in mm | Artikelnr. EPDM | Artikelnr. NBR |
|--------------|--------------|-----------------|----------------|
| LS-200-S-316 | 12,7 - 15,7  | 202500139       | 202500156      |
| LS-265-S-316 | 16 - 20      | 202500186       | -              |
| LS-275-S-316 | 16 - 20      | 202500140       | 202500150      |
| LS-300-S-316 | 18 - 22,5    | 202500141       | 202500151      |
| LS-310-S-316 | 18 - 22,5    | 202500187       | -              |
| LS-315-S-316 | 21,1 - 26    | 202500146       | 202500157      |
| LS-325-S-316 | 23,2 - 30    | 202500142       | 202500152      |
| LS-340-S-316 | 25,5 - 34    | 202500143       | 202500055      |
| LS-360-S-316 | 32 - 42      | 202500144       | 202500056      |
| LS-400-S-316 | 36,3 - 46    | 202500172       | 202500153      |
| LS-410-S-316 | 37 - 48,5    | 202500173       | 202500161      |
| LS-425-S-316 | 28,4 - 37    | 202500174       | 202500154      |
| LS-440-S-316 | 44 - 55      | 202500176       | 202500258      |
| LS-475-S-316 | 41,3 - 48,5  | 202500145       | 202500155      |
| LS-500-S-316 | 60,3 - 71,5  | 202500147       | 202500158      |
| LS-525-S-316 | 55,4 - 63,5  | 202500148       | 202500159      |
| LS-575-S-316 | 48 - 58      | 202500149       | 202500160      |
| LS-615-S-316 | 81,6 - 98    | 202500185       | 202500265      |
| LS-650-S-316 | 69 - 84      | 202500177       | 202500259      |

Artikelgroep: 16.02.05

\* EPDM rubber (blauw) op aanvraag leverbaar.

## PSI Pakkingen, afdichtingen en Petro-band

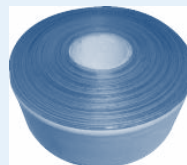
02

|                            | Afmeting in mm | Artikelnr. |
|----------------------------|----------------|------------|
| <b>Fig. 210</b>            | 32             | 101100004  |
| <b>Rubber instortflens</b> | 40             | 101100005  |
| <b>(muurdoorvoer)</b>      | 50             | 101100006  |
|                            | 63             | 101100007  |
|                            | 75             | 101100008  |
|                            | 90             | 101100009  |
|                            | 110            | 101100010  |
|                            | 125            | 101100011  |
|                            | 140            | 101100012  |
|                            | 160            | 101100013  |
|                            | 180            | 101100014  |
|                            | 200            | 101100015  |
|                            | 225            | 101100016  |
|                            | 250            | 101100017  |
|                            | 280            | 101100018  |
|                            | 315            | 101100019  |
|                            | 400            | 101100020  |
|                            | 450            | 101100021  |
|                            | 500            | 101100022  |
|                            | 560            | 101100023  |
|                            | 630            | 101100024  |
|                            | 800            | 101100029  |

Artikelgroep: 16.02.05



|  | Breedte in mm | Lengte in meter | Artikelnr.             |
|--|---------------|-----------------|------------------------|
| <b>Fig. 231</b>                                      | 50            | 15              | 4002S20088             |
| <b>Band voor afstandhouders</b>                      |               |                 | Artikelgroep: 16.02.05 |
| - anti-slip band voor het gebruik met afstandhouders |               |                 |                        |



|  | Type                | Artikelnr. |
|--|---------------------|------------|
| <b>Fig. 230</b>                            | Type AZ/AC 1- 16    | 300200085  |
| <b>Afstandhouder</b>                       | Type AZ/AC 1- 25    | 300200086  |
| - voor het leggen van leidingen in buis    | Type AZ/AC 1- 36    | 300200087  |
| - maatbereik leidingdiameter: 98 t/m 385mm | Type AZ/AC 1- 55    | 300200088  |
| - modulair systeem                         | Type AZ/AC 1- 75    | 300200089  |
|  | Type AZ/AC 1- 90    | 300200083  |
|  | Type AZ/AC 1-110    | 300200097  |
|  | Type AZ/AC 2- 16    | 300200090  |
|  | Type AZ/AC 2- 25    | 300200091  |
|  | Type AZ/AC 2- 36    | 300200092  |
|  | Type AZ/AC 2- 55    | 300200093  |
|  | Type AZ/AC 2- 75    | 300200094  |
|  | Type AZ/AC 2- 90    | 300200095  |
|  | Type AZ/AC 2-110    | 300200096  |
|  | Type MA 1- 25       | 300200050  |
|  | Type MA 1- 36       | 300200051  |
|  | Type MA 1- 50       | 300200053  |
|  | Type MA 1- 65       | 300200064  |
|  | Type MA 1- 75       | 300200054  |
|  | Type MA 2- 25       | 300200055  |
|  | Type MA 2- 36       | 300200056  |
|  | Type MA 2- 50       | 300200057  |
|  | Type MA 2- 65       | 300200063  |
|  | Type MA 2- 75       | 300200058  |
|  | Type PA/PE 2- 36*   | 300101018  |
|  | Type PA/PE 2,5- 36* | 300101022  |
|  | Type PA/PE 4- 16*   | 300101028  |
|  | Type PA/PE 9- 55*   | 300101123  |

Artikelgroep: 16.02.05



|                        | Breedte in mm | Artikelnr.             |
|------------------------|---------------|------------------------|
| <b>Fig. 240</b>        | 50            | 403500003              |
| <b>Kebu Petro-band</b> | 100           | 403500004              |
| - rol à 10 meter       |               | Artikelgroep: 16.02.05 |



|                           | Breedte in mm | Artikelnr.             |
|---------------------------|---------------|------------------------|
| <b>Fig. 243</b>           | 50            | 403500026              |
| <b>Kebu Reparatieband</b> |               | Artikelgroep: 16.02.05 |
| - rol à 10 meter          |               |                        |



|                        | Inhoud in gram | Artikelnr.             |
|------------------------|----------------|------------------------|
| <b>Fig. 246</b>        | 500            | 403500046              |
| <b>Kebu Kneadmassa</b> |                | Artikelgroep: 16.02.05 |



|                                       | Inhoud in ml | Artikelnr.             |
|---------------------------------------|--------------|------------------------|
| <b>Fig. 247</b>                       | 310          | 401522820              |
| <b>Stopaq afdichtingspasta FN2100</b> |              | Artikelgroep: 16.02.05 |



Neem voor de geschikte afstandhouder voor uw toepassing en het benodigde aantal contact op met onze afdeling verkoop.  
\* 1 ring = 2 stuks

## 02.02 Fittingen voor PVC drukleidingen

### PVC HV Hulpstukken gemaakt uit buis

- Deze handvorm fittingen zijn niet voorzien van enig garantiemerk.
- Daar waar staat 7½ ato en 12½ ato wordt bedoeld dat het hulpstuk uit buis 7½ ato of 12½ ato is gemaakt.
- Bochten en T-stukken zijn standaard voorzien van moffen. Op aanvraag kunnen wij ook andere uitvoeringen leveren.
- Kleur: donkergrijs.
- Afwijkende graderingen zijn op aanvraag leverbaar.

02

|  | Afmeting in mm | Artikelnr. PN6/7½ ato | Artikelnr. PN10/12½ ato |
|--|----------------|-----------------------|-------------------------|
| <b>1702</b><br>PVC Lijmmof<br>- handvorm | 32             | -                     | 1702032                 |
|  | 40             | -                     | 1702040                 |
|  | 50             | -                     | 1702050                 |
|  | 63             | 17020631              | 1702063                 |
|  | 75             | 17020751              | 1702075                 |
|  | 90             | 17020901              | 1702090                 |
|  | 110            | 17021101              | 1702110                 |
|  | 125            | 17021251              | 1702125                 |
|  | 140            | 17021401              | 1702140                 |
|  | 160            | 17021601              | 1702160                 |
|  | 180            | 17021801              | -                       |
|  | 200            | 17022001              | 1702200                 |
|  | 225            | 17022251              | -                       |
|  | 250            | 17022501              | 1702250                 |
|  | 315            | 17023151              | 1702315                 |
|  | 355            | 17023551              | 1702355                 |
|  | 400            | 17024001              | 1702400                 |
|  | 500            | 17025001              | -                       |

Artikelgroep: 02.02.20

|   | Afmeting in mm | Artikelnr. PN6/7½ ato | Artikelnr. PN10/12½ ato |
|---|----------------|-----------------------|-------------------------|
| <b>1703</b><br>PVC Verloopsok<br>- handvorm | 63 x 50        | -                     | 1703063050              |
|   | 75 x 50        | -                     | 1703075050              |
|   | 75 x 63        | -                     | 1703075063              |
|   | 90 x 63        | 1703090064            | 1703090063              |
|   | 90 x 75        | -                     | 1703090075              |
|   | 110 x 63       | 1703110064            | -                       |
|   | 110 x 75       | 1703110076            | 1703110075              |
|   | 110 x 90       | 1703110091            | 1703110090              |
|   | 125 x 90       | 1703125091            | 1703125090              |
|   | 125 x 110      | 1703125111            | 1703125110              |
|   | 140 x 110      | 1703140111            | 1703140110              |
|   | 140 x 125      | -                     | 1703140125              |
|   | 160 x 110      | 1703160111            | -                       |
|   | 160 x 125      | 1703160126            | 1703160125              |
|   | 160 x 140      | 1703160141            | 1703160140              |
|   | 200 x 125      | 1703200126            | -                       |
|   | 200 x 160      | -                     | 1703200160              |
|   | 225 x 200      | 1703225201            | 1703225200              |
|   | 250 x 200      | -                     | 1703250200              |
|   | 315 x 250      | 1703315251            | -                       |
| 355 x 315                                   | 1703355316     | -                     |                         |
| 400 x 315                                   | 1703400316     | 1703400315            |                         |

Artikelgroep: 02.02.20

|  | Afmeting in mm | Artikelnr. |
|--|----------------|------------|
| <b>1710</b><br>PVC Eindkap<br>- handvorm | 63             | 1710063    |
|  | 75             | 1710075    |
|  | 90             | 1710090    |
|  | 110            | 1710110    |
|  | 125            | 1710125    |
|  | 140            | 1710140    |
|  | 160            | 1710160    |
|  | 180            | 1710180    |
|  | 200            | 1710200    |
|  | 225            | 1710225    |
|  | 250            | 1710250    |
|  | 280            | 1710280    |
|  | 315            | 1710315    |
|  | 400            | 1710400    |
|  | 500            | 1710500    |

Artikelgroep: 02.02.20

|  | Afmeting in mm | Artikelnr. PN6/7½ ato | Artikelnr. PN10/12½ ato |
|--|----------------|-----------------------|-------------------------|
| <b>1701</b><br>PVC Bocht 90°<br>- handvorm | 32             | -                     | 1701032                 |
|  | 40             | -                     | 1701040                 |
|  | 50             | -                     | 1701050                 |
|  | 63             | -                     | 1701063                 |
|  | 75             | -                     | 1701075                 |
|  | 90             | -                     | 1701090                 |
|  | 110            | -                     | 1701110                 |
|  | 125            | -                     | 1701125                 |
|  | 140            | 17011401              | 1701140                 |
|  | 160            | -                     | 1701160                 |
|  | 180            | 17011801              | 1701180                 |
|  | 200            | 17012001              | 1701200                 |
|  | 225            | 17012251              | 1701225                 |
|  | 250            | -                     | 1701250                 |
|  | 280            | 17012801              | 1701280                 |
|  | 315            | 17013151              | 1701315                 |
| 400  | 17014001       | -                     |                         |

Artikelgroep: 02.02.20

|  | Afmeting in mm | Artikelnr. PN6/7½ ato | Artikelnr. PN10/12½ ato |
|--|----------------|-----------------------|-------------------------|
| <b>1700</b><br>PVC Bocht 45°<br>- handvorm | 32             | -                     | 1700032                 |
|  | 40             | -                     | 1700040                 |
|  | 50             | -                     | 1700050                 |
|  | 63             | -                     | 1700063                 |
|  | 75             | -                     | 1700075                 |
|  | 90             | -                     | 1700090                 |
|  | 110            | -                     | 1700110                 |
|  | 125            | -                     | 1700125                 |
|  | 140            | 17001401              | 1700140                 |
|  | 160            | 17001601              | 1700160                 |
|  | 180            | -                     | 1700180                 |
|  | 200            | 17002001              | 1700200                 |
|  | 225            | 17002251              | 1700225                 |
|  | 250            | 17002501              | 1700250                 |
|  | 315            | 17003151              | 1700315                 |
|  | 400            | 17004001              | -                       |

Artikelgroep: 02.02.20

## PVC HV Hulpstukken gemaakt uit buis

|                   | Afmeting<br>in mm | Artikelnr.<br>PN6/7½ ato | Artikelnr.<br>PN10/12½ ato |
|-------------------|-------------------|--------------------------|----------------------------|
| <b>1709</b>       | 110 x 50          | -                        | 1709110050                 |
| <b>PVC T-stuk</b> | 110 x 63          | 1709110064               | -                          |
| <b>90°</b>        | 110 x 75          | 1709110076               | -                          |
| - handvorm        | 110 x 90          | 1709110091               | -                          |
|                   | 110 x 110         | 1709110111               | -                          |
|                   | 125 x 50          | 1709125051               | -                          |
|                   | 125 x 63          | 1709125064               | -                          |
|                   | 125 x 75          | 1709125076               | -                          |
|                   | 125 x 90          | 1709125091               | -                          |
|                   | 125 x 110         | 1709125111               | -                          |
|                   | 125 x 125         | 1709125126               | -                          |
|                   | 140 x 110         | -                        | 1709140110                 |
|                   | 140 x 140         | 1709140141               | -                          |
|                   | 160 x 50          | 1709160051               | 1709160050                 |
|                   | 160 x 63          | 1709160064               | 1709160063                 |
|                   | 160 x 75          | 1709160076               | -                          |
|                   | 160 x 90          | 1709160091               | 1709160090                 |
|                   | 160 x 110         | 1709160111               | 1709160110                 |
|                   | 160 x 125         | 1709160126               | 1709160125                 |
|                   | 160 x 160         | 1709160161               | 1709160160                 |
|                   | 200 x 50          | -                        | 1709200050                 |
|                   | 200 x 63          | 1709200064               | -                          |
|                   | 200 x 75          | 1709200076               | 1709200075                 |
|                   | 200 x 90          | 1709200091               | 1709200090                 |
|                   | 200 x 110         | -                        | 1709200110                 |
|                   | 200 x 125         | 1709200126               | 1709200125                 |
|                   | 200 x 160         | 1709200161               | -                          |
|                   | 200 x 200         | 1709200201               | 1709200200                 |
|                   | 250 x 50          | 1709250051               | 1709250050                 |
|                   | 250 x 63          | 1709250064               | -                          |
|                   | 250 x 75          | 1709250076               | -                          |
|                   | 250 x 90          | 1709250091               | -                          |
|                   | 250 x 110         | 1709250111               | 1709250110                 |
|                   | 250 x 125         | 1709250126               | 1709250125                 |
|                   | 250 x 160         | 1709250161               | -                          |
|                   | 250 x 200         | 1709250201               | 1709250200                 |
|                   | 250 x 250         | 1709250251               | 1709250250                 |
|                   | 315 x 75          | 1709315076               | -                          |
|                   | 315 x 125         | 1709315126               | -                          |
|                   | 315 x 160         | 1709315161               | -                          |
|                   | 315 x 200         | 1709315201               | -                          |
|                   | 315 x 250         | 1709315251               | -                          |
|                   | 315 x 315         | 1709315316               | -                          |

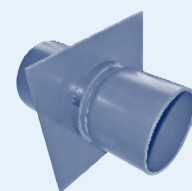
Artikelgroep: 02.02.20

Deze handvormfittingen zijn niet voorzien van enig garantiemerk.



## PVC HV Wanddoorvoer gemaakt uit buis

|                         | Afmeting<br>in mm | Artikelnr.<br>Ongezand | Artikelnr.<br>Gezand |
|-------------------------|-------------------|------------------------|----------------------|
| <b>1704</b>             | 40                | 1704040300             | 1704040301           |
| <b>PVC Wanddoorvoer</b> | 50                | 1704050300             | 1704050301           |
| - lengte: standaard     | 63                | 1704063300             | 1704063301           |
| 300mm                   | 75                | 1704075300             | 1704075301           |
| - handvorm              | 90                | 1704090300             | 1704090301           |
|                         | 110               | 1704110300             | 1704110301           |
|                         | 125               | 1704125300             | 1704125301           |
|                         | 160               | 1704160300             | 1704160301           |
|                         | 200               | 1704200300             | 1704200301           |
|                         | 250               | 1704250300             | 1704250301           |
|                         | 315               | 1704315300             | 1704315301           |
|                         | 400               | 1704400300             | 1704400301           |



Artikelgr.: 02.02.21

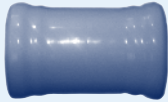
Afwijkende lengten of diameters zijn op aanvraag leverbaar.  
Deze handvormfittingen zijn niet voorzien van enig garantiemerk.



# 02.02 Fittingen voor PVC drukleidingen


## PVC Drukfittingen met manchetverbinding

02

|   | Afmeting in mm | Artikelnr.             |
|---|----------------|------------------------|
| <b>7901</b>   | 50             | 7901050                |
| <b>PVC Reparatie-koppeling</b>  | 63             | 7901063                |
|   | 75             | 7901075                |
| - lang model  | 90             | 7901090                |
| - kleur: crème  | 110            | 7901110                |
|   | 125            | 7901125                |
|   | 160            | 7901160                |
|   | 200            | 7901200                |
|   | 250            | 7901250                |
|   | 315            | 7901315                |
|   | 400            | 7901400                |
|  |                |                        |
|   |                | Artikelgroep: 02.02.25 |


|   | Afmeting in mm | Artikelnr.             |
|---|----------------|------------------------|
| <b>4180</b>   | 75 x 63        | 4180075063             |
| <b>PVC Manchet verloopmof</b>   | 90 x 75        | 4180090075             |
|   | 110 x 63       | 4180110063             |
|   | 110 x 90       | 4180110090             |
|   | 125 x 110      | 4180125110             |
|   | 160 x 110      | 4180160110             |
|   | 160 x 125      | 4180160125             |
|   | 200 x 160      | 4180200160             |
|  |                |                        |
|   |                | Artikelgroep: 02.02.25 |

|   | Afmeting in mm | Artikelnr.             |
|---|----------------|------------------------|
| <b>4010</b>   | 50             | 4010050                |
| <b>PVC Manchet overschuifmof</b>  | 63             | 4010063                |
|   | 75             | 4010075                |
|   | 90             | 4010090                |
|   | 110            | 4010110                |
|   | 125            | 4010125                |
|   | 140            | 4010140                |
|   | 160            | 4010160                |
|   | 180            | 4010180                |
|   | 200            | 4010200                |
|   | 225            | 4010225                |
|   | 250            | 4010250                |
|   | 280            | 4010280                |
|   | 315            | 4010315                |
|  |                |                        |
|   |                | Artikelgroep: 02.02.25 |

|   | Afmeting in mm | Artikelnr.             |
|---|----------------|------------------------|
| <b>4550</b>   | 63             | 4550063                |
| <b>PVC Manchetbocht 90°</b>   | 75             | 4550075                |
|   | 90             | 4550090                |
|   | 110            | 4550110                |
|   | 125            | 4550125                |
|   | 160            | 4550160                |
|   | 200            | 4550200                |
|  |                |                        |
|   |                | Artikelgroep: 02.02.25 |

|   | Afmeting in mm | Artikelnr.             |
|---|----------------|------------------------|
| <b>40101</b>  | 50             | 40100501               |
| <b>PVC Manchet steekmof</b>   | 63             | 40100631               |
|   | 75             | 40100751               |
|   | 90             | 40100901               |
|   | 110            | 40101101               |
|   | 125            | 40101251               |
|   | 160            | 40101601               |
|   | 200            | 40102001               |
|   | 225            | 40102251               |
|   | 250            | 40102501               |
|   | 280            | 40102801               |
|   | 315            | 40103151               |
|  |                |                        |
|   |                | Artikelgroep: 02.02.25 |

|   | Afmeting in mm | Artikelnr.             |
|---|----------------|------------------------|
| <b>4510</b>   | 63             | 451045063              |
| <b>PVC Manchetbocht 45°</b>   | 75             | 451045075              |
|   | 90             | 451045090              |
|   | 110            | 451045110              |
|   | 125            | 451045125              |
|   | 160            | 451045160              |
|   | 200            | 451045200              |
|  |                |                        |
|   |                | Artikelgroep: 02.02.25 |

|   | Afmeting in mm | Artikelnr.             |
|---|----------------|------------------------|
| <b>4080</b>   | 63             | 4080063                |
| <b>PVC Manchetmof - met flens</b>   | 75             | 4080075                |
|   | 90             | 4080090                |
|   | 110            | 4080110                |
|   | 125            | 4080125                |
|   | 140            | 4080140                |
|   | 160            | 4080160                |
|   | 200            | 4080200                |
|   | 225            | 4080225                |
|   | 250            | 4080250                |
|   | 280            | 4080280                |
|   | 315            | 4080315                |
|  |                |                        |
|   |                | Artikelgroep: 02.02.25 |

|   | Afmeting in mm | Artikelnr.             |
|---|----------------|------------------------|
| <b>4040</b>   | 63             | 4040063                |
| <b>PVC Manchet T-stuk 90°</b>   | 75             | 4040075                |
|   | 90             | 4040090                |
|   | 110            | 4040110                |
|   | 125            | 4040125                |
|   | 140            | 4040140                |
|   | 160            | 4040160                |
|   | 200            | 4040200                |
|  |                |                        |
|   |                | Artikelgroep: 02.02.25 |

## PVC Kogelkranen

|                       | Afmeting in mm | Artikelnr. |
|-----------------------|----------------|------------|
| <b>1250</b>           | 16             | 1250016    |
| <b>PVC Kogelkraan</b> | 20             | 1250020    |
| - met lijmsokken      | 25             | 1250025    |
| - 2 x wartel          | 32             | 1250032    |
| - radiaal uitbouwbaar | 40             | 1250040    |
| - EPDM O-ringen       | 50             | 1250050    |
| - met bi-stop         | 63             | 1250063    |
|                       | 75             | 1250075    |
|                       | 90             | 1250090    |
|                       | 110            | 1250110    |



Artikelgroep: 02.03.05

|                       | Afmeting in mm | Artikelnr. |
|-----------------------|----------------|------------|
| <b>1150</b>           | 16             | 1150016    |
| <b>PVC Kogelkraan</b> | 20             | 1150020    |
| - met lijmsokken      | 25             | 1150025    |
| - 2 x wartel          | 32             | 1150032    |
| - radiaal uitbouwbaar | 40             | 1150040    |
| - EPDM O-ringen       | 50             | 1150050    |
|                       | 63             | 1150063    |
|                       | 75             | 1150075    |
|                       | 90             | 1150090    |
|                       | 110            | 1150110    |



Artikelgroep: 02.03.05

|                       | Afmeting | Artikelnr. |
|-----------------------|----------|------------|
| <b>1251</b>           | 3/8"     | 1251038    |
| <b>PVC Kogelkraan</b> | 1/2"     | 1251012    |
| - met draadsokken     | 3/4"     | 1251034    |
| - 2 x wartel          | 1"       | 1251100    |
| - radiaal uitbouwbaar | 1 1/4"   | 1251114    |
| - EPDM O-ringen       | 1 1/2"   | 1251112    |
| - met bi-stop         | 2"       | 1251200    |
|                       | 2 1/2"   | 1251212    |
|                       | 3"       | 1251300    |
|                       | 4"       | 1251400    |



Artikelgroep: 02.03.05

|                       | Afmeting | Artikelnr. |
|-----------------------|----------|------------|
| <b>1151</b>           | 3/8"     | 1151038    |
| <b>PVC Kogelkraan</b> | 1/2"     | 1151012    |
| - met draadsokken     | 3/4"     | 1151034    |
| - 2 x wartel          | 1"       | 1151100    |
| - radiaal uitbouwbaar | 1 1/4"   | 1151114    |
| - EPDM O-ringen       | 1 1/2"   | 1151112    |
|                       | 2"       | 1151200    |
|                       | 2 1/2"   | 1151212    |
|                       | 3"       | 1151300    |
|                       | 4"       | 1151400    |



Artikelgroep: 02.03.05

|                       | Afmeting in mm | Artikelnr. |
|-----------------------|----------------|------------|
| <b>1280</b>           | 16             | 1280016    |
| <b>PVC Kogelkraan</b> | 20             | 1280020    |
| - met lijmsokken      | 25             | 1280025    |
| - 2 x wartel          | 32             | 1280032    |
| - radiaal uitbouwbaar | 40             | 1280040    |
| - FPM (Viton)         | 50             | 1280050    |
| O-ringen              | 63             | 1280063    |
|                       | 75             | 1280075    |
|                       | 90             | 1280090    |
|                       | 110            | 1280110    |



Artikelgroep: 02.03.05

|                       | Afmeting in mm | Artikelnr. |
|-----------------------|----------------|------------|
| <b>1410</b>           | 16             | 1410016    |
| <b>PVC Kogelkraan</b> | 20             | 1410020    |
| - met lijmsokken      | 25             | 1410025    |
| - 2 x wartel          | 32             | 1410032    |
| - radiaal uitbouwbaar | 40             | 1410040    |
| - EPDM O-ringen       | 50             | 1410050    |
|                       | 63             | 1410063    |
|                       | 75             | 1410075    |



Artikelgroep: 02.03.05

|                       | Afmeting | Artikelnr. |
|-----------------------|----------|------------|
| <b>1281</b>           | 3/8"     | 1281038    |
| <b>PVC Kogelkraan</b> | 1/2"     | 1281012    |
| - met draadsokken     | 3/4"     | 1281034    |
| - 2 x wartel          | 1"       | 1281100    |
| - radiaal uitbouwbaar | 1 1/4"   | 1281114    |
| - FPM (Viton)         | 1 1/2"   | 1281112    |
| O-ringen              | 2"       | 1281200    |
|                       | 3"       | 1281300    |
|                       | 4"       | 1281400    |



Artikelgroep: 02.03.05

|                       | Afmeting in mm | Artikelnr. |
|-----------------------|----------------|------------|
| <b>1490</b>           | 16             | 1490016    |
| <b>PVC Kogelkraan</b> | 20             | 1490020    |
| - met lijmsokken      | 25             | 1490025    |
| - 2 x wartel          | 32             | 1490032    |
| - radiaal uitbouwbaar | 40             | 1490040    |
| - FPM (Viton)         | 50             | 1490050    |
| O-ringen              | 63             | 1490063    |



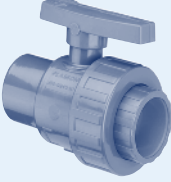
Artikelgroep: 02.03.05

# 02.03 Afsluiters voor PVC drukleidingen

## PVC Kogelkranen

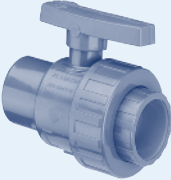
02

|                       | Afmeting in mm | Artikelnr. |
|-----------------------|----------------|------------|
| <b>1350</b>           | 16             | 1350016    |
| <b>PVC Kogelkraan</b> | 20             | 1350020    |
| - met lijmsokken      | 25             | 1350025    |
| - 1 x wartel          | 32             | 1350032    |
| - EPDM O-ringen       | 40             | 1350040    |
|                       | 50             | 1350050    |
|                       | 63             | 1350063    |
|                       | 75             | 1350075    |
|                       | 90             | 1350090    |
|                       | 110            | 1350110    |



Artikelgroep: 02.03.05

|                       | Afmeting | Artikelnr. |
|-----------------------|----------|------------|
| <b>1351</b>           | 3/8"     | 1351038    |
| <b>PVC Kogelkraan</b> | 1/2"     | 1351012    |
| - met BSP binnendraad | 3/4"     | 1351034    |
| - 1 x wartel          | 1"       | 1351100    |
| - EPDM O-ringen       | 1 1/4"   | 1351114    |
|                       | 1 1/2"   | 1351112    |
|                       | 2"       | 1351200    |
|                       | 2 1/2"   | 1351212    |
|                       | 3"       | 1351300    |
|                       | 4"       | 1351400    |



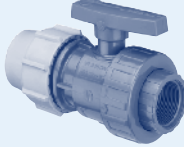
Artikelgroep: 02.03.05

|                             | Afmeting | Artikelnr. |
|-----------------------------|----------|------------|
| <b>1361</b>                 | 3/8"     | 1361038    |
| <b>PVC Kogelkraan</b>       | 1/2"     | 1361012    |
| - binnendraad x buitendraad | 3/4"     | 1361034    |
| - 1 x wartel                | 1"       | 1361100    |
| - EPDM O-ringen             | 1 1/4"   | 1361114    |
|                             | 1 1/2"   | 1361112    |
|                             | 2"       | 1361200    |



Artikelgroep: 02.03.05

|                         | Afmeting    | Artikelnr. |
|-------------------------|-------------|------------|
| <b>1379</b>             | 20 x 1/2"   | 1379020012 |
| <b>PVC Kogelkraan</b>   | 25 x 3/4"   | 1379025034 |
| - binnendraad x PE klem | 32 x 1"     | 1379032100 |
|                         | 40 x 1 1/4" | 1379040114 |
|                         | 50 x 1 1/2" | 1379050112 |
|                         | 63 x 2"     | 1379063200 |



Artikelgroep: 02.03.05

|                             | Afmeting in mm | Artikelnr. |
|-----------------------------|----------------|------------|
| <b>6300</b>                 | 20             | 6300020    |
| <b>PVC 3-Weg kogelkraan</b> | 25             | 6300025    |
| - L-boring                  | 32             | 6300032    |
| - met lijmmoffen            | 40             | 6300040    |
| - 3 x wartel                | 50             | 6300050    |
| - EPDM O-ringen             | 63             | 6300063    |



Artikelgroep: 02.03.05

|                             | Afmeting in mm | Artikelnr. |
|-----------------------------|----------------|------------|
| <b>63001</b>                | 20             | 63000201   |
| <b>PVC 3-Weg kogelkraan</b> | 25             | 63000251   |
| - T-boring                  | 32             | 63000321   |
| - met lijmmoffen            | 40             | 63000401   |
| - 3 x wartel                | 50             | 63000501   |
| - EPDM O-ringen             | 63             | 63000631   |



Artikelgroep: 02.03.05

## PVC Vuilvangers

|                       | Afmeting in mm | Artikelnr.             |
|-----------------------|----------------|------------------------|
| <b>1660</b>           | 75             | 1660075                |
| <b>PVC Vuilvanger</b> | 90             | 1660090                |
| - 2 x lijmmof         | 110            | 1660110                |
| - EPDM O-ringen       |                | Artikelgroep: 02.03.10 |
| - huis: transparant   |                |                        |



|                          | Afmeting in mm | Artikelnr. |
|--------------------------|----------------|------------|
| <b>1661</b>              | 16             | 1661016    |
| <b>PVC Vuilvanger</b>    | 20             | 1661020    |
| - met 3-delige koppeling | 25             | 1661025    |
| - radiaal uitbouwbaar    | 32             | 1661032    |
| - EPDM O-ringen          | 40             | 1661040    |
| - huis: transparant      | 50             | 1661050    |
|                          | 63             | 1661063    |



Artikelgroep: 02.03.10

## PVC Terugslagkleppen

|                          | Afmeting in mm | Artikelnr. |
|--------------------------|----------------|------------|
| <b>1060</b>              | 16             | 1060016    |
| <b>PVC Terugslagklep</b> | 20             | 1060020    |
| - 2 x lijmmof            | 25             | 1060025    |
| - veerbelast             | 32             | 1060032    |
| - EPDM O-ringen          | 40             | 1060040    |
|                          | 50             | 1060050    |
|                          | 63             | 1060063    |
|                          | 75             | 1060075    |
|                          | 90             | 1060090    |
|                          | 110            | 1060110    |



Artikelgroep: 02.03.15

|                          | Afmeting in mm | Artikelnr. |
|--------------------------|----------------|------------|
| <b>1080</b>              | 16             | 1080016    |
| <b>PVC Terugslagklep</b> | 20             | 1080020    |
| - veerbelast             | 25             | 1080025    |
| - met PTFE               | 32             | 1080032    |
| gecoate veer             | 40             | 1080040    |
| - EPDM O-ringen          | 50             | 1080050    |
|                          | 63             | 1080063    |
|                          | 75             | 1080075    |
|                          | 90             | 1080090    |
|                          | 110            | 1080110    |



Artikelgroep: 02.03.15

|                          | Afmeting in mm | Artikelnr. |
|--------------------------|----------------|------------|
| <b>1000</b>              | 16             | 1000016    |
| <b>PVC Terugslagklep</b> | 20             | 1000020    |
| - 2 x lijmmof            | 25             | 1000025    |
| - veerbelast             | 32             | 1000032    |
| - FPM (viton) O-ringen   | 40             | 1000040    |
|                          | 50             | 1000050    |
|                          | 63             | 1000063    |



Artikelgroep: 02.03.15

|                          | Afmeting in mm | Artikelnr.             |
|--------------------------|----------------|------------------------|
| <b>1650</b>              | 75             | 1650075                |
| <b>PVC Terugslagklep</b> | 90             | 1650090                |
| - 2 x lijmmof            | 110            | 1650110                |
| - EPDM O-ringen          |                | Artikelgroep: 02.03.15 |



|                          | Afmeting in mm | Artikelnr. |
|--------------------------|----------------|------------|
| <b>1640</b>              | 16             | 1640016    |
| <b>PVC Terugslagklep</b> | 20             | 1640020    |
| - 2 x lijmmof            | 25             | 1640025    |
| - niet veerbelast        | 32             | 1640032    |
| - EPDM O-ringen          | 40             | 1640040    |
|                          | 50             | 1640050    |
|                          | 63             | 1640063    |
|                          | 75             | 1640075    |
|                          | 90             | 1640090    |
|                          | 110            | 1640110    |



Artikelgroep: 02.03.15

|                          | Afmeting in mm | Artikelnr. |
|--------------------------|----------------|------------|
| <b>1651</b>              | 16             | 1651016    |
| <b>PVC Terugslagklep</b> | 20             | 1651020    |
| - 2 x lijmmof            | 25             | 1651025    |
| - met 3-delige koppeling | 32             | 1651032    |
| - radiaal uitbouwbaar    | 40             | 1651040    |
| - EPDM O-ringen          | 50             | 1651050    |
|                          | 63             | 1651063    |



Artikelgroep: 02.03.15

|                          | Afmeting in mm | Artikelnr. |
|--------------------------|----------------|------------|
| <b>1600</b>              | 16             | 1600016    |
| <b>PVC Terugslagklep</b> | 20             | 1600020    |
| - 2 x lijmmof            | 25             | 1600025    |
| - niet veerbelast        | 32             | 1600032    |
| - FPM (viton) O-ringen   | 40             | 1600040    |
|                          | 50             | 1600050    |
|                          | 63             | 1600063    |




Artikelgroep: 02.03.15

|                          | Afmeting in mm | Artikelnr. |
|--------------------------|----------------|------------|
| <b>5048</b>              | 32             | 5048032    |
| <b>PVC Terugslagklep</b> | 40             | 5048040    |
| - met volle doorlaat     | 50             | 5048050    |
|                          | 63             | 5048063    |



Artikelgroep: 02.03.15

|  | Afmeting in mm | Doorlaat | Artikelnr. |         |
|--|----------------|----------|------------|---------|
| <b>6308</b><br><b>PP Terugslagklep</b> | 63             | DN50     | 32         | 6308063 |
|  | 75             | DN65     | 40         | 6308075 |
|  | 90             | DN80     | 52         | 6308090 |
|  | 110            | DN100    | 70         | 6308110 |
|  | 125/140        | DN125    | 92         | 6308125 |
|  | 160            | DN150    | 112        | 6308160 |
|  | 200/225        | DN200    | 150        | 6308200 |
|  | 250/280        | DN250    | 190        | 6308250 |
|  | 315            | DN300    | 216        | 6308315 |



Artikelgroep: 03.03.05

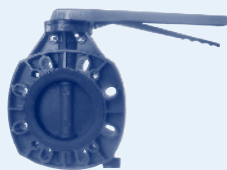
# 02.03 Afsluiters voor PVC drukleidingen

## PVC Vlinderkleppen

02

### 6302

**PVC Vlinderklep**  
- EPDM afdichting



Afmeting in mm      Artikelnr.

|           |         |
|-----------|---------|
| 63/75     | 6302075 |
| 90        | 6302090 |
| 110       | 6302110 |
| 125 /140* | 6302125 |
| 160       | 6302160 |
| 200/225*  | 6302200 |
| 250       | 6302250 |
| 315       | 6302315 |

Artikelgroep: 02.03.20

Ook leverbaar met FPM (viton) afdichting.

\* Voor deze maten gebruikt u de verloopkraagbus zie blz. 80, artikelnr. 5521.

## Afsluiters overig

### 1630

**PVC Be- en ontluichtingsventiel**  
- 2 x lijmmof  
- EPDM O-ringen



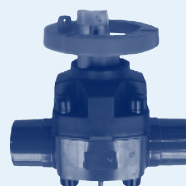
Afmeting in mm      Artikelnr.

|    |         |
|----|---------|
| 16 | 1630016 |
| 20 | 1630020 |
| 25 | 1630025 |
| 32 | 1630032 |
| 40 | 1630040 |
| 50 | 1630050 |
| 63 | 1630063 |

Artikelgroep: 02.03.25

### 1400

**PVC Membraanafsluiter**  
- 2 x spie  
- met EPDM membraan



Afmeting in mm      Artikelnr.

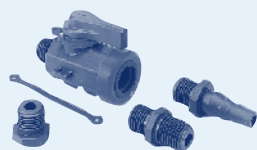
|    |         |
|----|---------|
| 20 | 1400020 |
| 25 | 1400025 |
| 32 | 1400032 |
| 40 | 1400040 |
| 50 | 1400050 |
| 63 | 1400063 |
| 75 | 1400075 |
| 90 | 1400090 |

Artikelgroep: 02.03.25

\* Ook leverbaar met PTFE membraan.

### 6317

**PVC Laboratoriumkraan**  
- binnendraad x buitendraad  
- FPM (viton) afdichting  
- compleet met diverse aansluitmogelijkheden (dubbele nippel, stop, slangtule)



Afmeting      Artikelnr.

|      |      |
|------|------|
| 1/4" | 6317 |
|------|------|

Artikelgroep: 02.03.25

### 1300

**6-Weg spoelklep Ocean V6**  
- type 'AO'  
- gemaakt van ABS



Afmeting      Artikelnr.

|        |        |
|--------|--------|
| 1 1/2" | 130099 |
| 2"     | 130101 |

Artikelgroep: 02.03.25

### 6319

**PVC Schuifafsluiter**  
- 2 x lijmmof



Afmeting in mm      Artikelnr.

|     |         |
|-----|---------|
| 32  | 6319032 |
| 50  | 6319050 |
| 63  | 6319063 |
| 75  | 6319075 |
| 90  | 6319090 |
| 110 | 6319110 |

Artikelgroep: 02.03.25

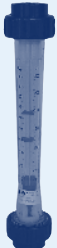
Voor afstandbediende afsluiters verwijzen wij u naar Groep 4 'Afstandbediende afsluiters'.

## Doorstroommeters

02


|                        | Afmeting<br>in mm | Meetbereik<br>liter/uur | Artikelnr. |
|------------------------|-------------------|-------------------------|------------|
| <b>7861</b>            | 32                | 50 - 500                | 786100500  |
| <b>Doorstroommeter</b> | 32                | 100 - 1000              | 786101000  |
| - polyamid/nylon       | 40                | 150 - 1500              | 786101500  |
| meetbuis               | 40                | 250 - 2500              | 786102500  |
| - kunststof beklede    | 50                | 200 - 2000              | 786102000  |
| drijver                | 50                | 300 - 3000              | 786103000  |
|                        | 63                | 600 - 6000              | 786106000  |
|                        | 63                | 1000 - 10000            | 786110000  |
|                        | 63                | 1500 - 15000            | 786115000  |
|                        | 75                | 2000 - 20000            | 786120000  |
|                        | 75                | 3000 - 30000            | 786130000  |
|                        | 75                | 8000 - 60000            | 786160000  |

Artikelgroep: 02.03.30



|                        | Afmeting<br>in mm | Meetbereik<br>liter/uur | Artikelnr. |
|------------------------|-------------------|-------------------------|------------|
| <b>7871</b>            | 32                | 50 - 500                | 787100500  |
| <b>Doorstroommeter</b> | 32                | 100 - 1000              | 787101000  |
| - polyamid/nylon       | 40                | 150 - 1500              | 787101500  |
| meetbuis               | 40                | 250 - 2500              | 787102500  |
| - magneet drijver      | 50                | 200 - 2000              | 787102000  |
|                        | 50                | 300 - 3000              | 787103000  |
|                        | 63                | 600 - 6000              | 787106000  |
|                        | 63                | 1000 - 10000            | 787110000  |
|                        | 63                | 1500 - 15000            | 787115000  |
|                        | 75                | 2000 - 20000            | 787120000  |
|                        | 75                | 3000 - 30000            | 787130000  |
|                        | 75                | 8000 - 60000            | 787160000  |

Artikelgroep: 02.03.30



|                             | Type | Artikelnr.             |
|-----------------------------|------|------------------------|
| <b>7872</b>                 | Min. | 787201                 |
| <b>Readcontact</b>          | Max. | 787202                 |
| - voor doorstroommeter 7871 |      | Artikelgroep: 02.03.30 |



Voor het gebruik van een readcontact dient uw stromingsmeter voorzien te zijn van een magneetdrijver.

# 02.04 Toebehoren voor PVC drukleidingen

## Lijm, reiniger en kwasten

- De keuze van de lijmsoort is afhankelijk van de toepassing.
- Wij wijzen u erop dat reinigingsmiddelen zijn vereist voor een goede lijmverbinding.
- Raadpleeg voor gebruik de toepassings- en veiligheidsvoorschriften.

02

|  | Inhoud in ml | Artikelnr.             |
|--|--------------|------------------------|
| <b>1724</b><br><b>Tangit lijm met drukdeksel</b>           | blik 1000    | 17241000               |
| - voor het lijmen van PVC drukleidingen<br>- KIWA/ATA keur |              | Artikelgroep: 19.01.05 |



|  | Inhoud in ml | Artikelnr.             |
|--|--------------|------------------------|
| <b>1723</b><br><b>Tangit lijm met kwast</b>                | tube 125     | 17230125               |
| - voor het lijmen van PVC drukleidingen<br>- KIWA/ATA keur | blik 250     | 17230250               |
|  | blik 500     | 17230500               |
|  | blik 1000    | 17231000               |
|  | blik 4500 *  | 17234500               |
|  |              | Artikelgroep: 19.01.05 |



\* Zonder kwast.

|  | Inhoud in ml | Artikelnr.             |
|--|--------------|------------------------|
| <b>171288</b><br><b>T-88 lijm met kwast</b>                          | pot 100      | 1712880100             |
| - voor het verlijmen van afvoer- en drukleidingen<br>- KIWA/ATA keur | pot 250      | 1712880250             |
|  | pot 500      | 1712880500             |
|  | pot 1000     | 1712881000             |
|  | blik 5000 *  | 1712885000             |
|  |              | Artikelgroep: 19.01.05 |



\* Zonder kwast.

|  | Inhoud in ml | Artikelnr.             |
|--|--------------|------------------------|
| <b>1712100</b><br><b>UNI-100 lijm met kwast</b>            | pot 250      | 17121000250            |
| - voor het lijmen van PVC drukleidingen<br>- KIWA/ATA keur | pot 500      | 17121000500            |
|  | blik 1000    | 17121001000            |
|  | blik 5000 *  | 17121005000            |
|  |              | Artikelgroep: 19.01.05 |




\* Zonder kwast.

|   | Inhoud in ml | Artikelnr.             |
|---|--------------|------------------------|
| <b>17121</b><br><b>UNI-100 GT lijm met kwast</b>                            | blik 1000    | 171211001000           |
| - langzaam drogend<br>- speciaal voor grotere afmetingen<br>- KIWA/ATA keur | blik 5000 *  | 171211005000           |
|   |              | Artikelgroep: 19.01.05 |



\* Zonder kwast.

|  | Inhoud in ml   | Artikelnr.             |
|--|----------------|------------------------|
| <b>17122</b><br><b>UNI-100 XT lijm met kwast</b> | tube 125*      | 171221000125           |
| - THF-vrij                                       | pot 250        | 171221000250           |
|  | pot 500        | 171221000500           |
|  | pot 1000       | 171221001000           |
|  | jerrycan 5000* | 171221005000           |
|  |                | Artikelgroep: 19.01.05 |



\* Zonder kwast.

|   | Inhoud in ml | Artikelnr.             |
|---|--------------|------------------------|
| <b>1706</b><br><b>Griffon WDF-05 sneldrogende lijm</b>                | pot 500      | 17060500               |
| - voor het lijmen van flexibele slangen, PVC afvoer- en drukleidingen |              | Artikelgroep: 19.01.05 |



|  | Inhoud in ml | Artikelnr.             |
|--|--------------|------------------------|
| <b>1707</b><br><b>Griffon HCR-36 lijm</b>  | pot 1000     | 17071000               |
| - voor het verlijmen van buizen en fittingen met nauwe passing in druk- en afvoersystemen<br>- tevens geschikt voor C-PVC (max. 60°C)<br>- speciaal voor verbindingen waarbij een hoge chemische bestendigheid is vereist<br>- geschikt voor diameters ≤ 160 mm<br>- max. 10 bar<br>- gebruiken in combinatie met HCR-reiniger zie blz. 103, artikelnr. 1708 |              | Artikelgroep: 19.01.05 |




## Lijm, reiniger en kwasten

|                                | Inhoud in ml | Artikelnr.                         |
|--------------------------------|--------------|------------------------------------|
| <b>1725</b><br>Tangit reiniger | blik 1000    | 17251000<br>Artikelgroep: 19.01.05 |



|                          | Inhoud in kg | Artikelnr.                     |
|--------------------------|--------------|--------------------------------|
| <b>1760</b><br>Moffenkit | 15           | 1760<br>Artikelgroep: 19.01.10 |



|   | Inhoud in ml | Artikelnr.                          |
|---|--------------|-------------------------------------|
| <b>1713</b><br>Griffon reiniger<br>- voor het reinigen van<br>PVC/C-PVC/Blue-system | blik 125     | 171300125                           |
|   | blik 500     | 171300500                           |
|   | blik 1000    | 171301000                           |
|   | blik 5000    | 171305000<br>Artikelgroep: 19.01.05 |



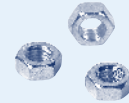
|                                      | Afmeting in mm | Artikelnr.                        |
|--------------------------------------|----------------|-----------------------------------|
| <b>1727</b><br>Kwast<br>- plat model | 30             | 1727030                           |
|                                      | 50             | 1727050                           |
| <b>1727</b><br>Kwast<br>- rond model | 10             | 1727010                           |
|                                      | 12             | 1727012                           |
|                                      | 16             | 1727016                           |
|                                      | 18             | 1727018                           |
|                                      | 20             | 1727020<br>Artikelgroep: 19.02.05 |




|  | Inhoud in ml | Artikelnr.                         |
|--|--------------|------------------------------------|
| <b>1708</b><br>Griffon HCR-36 reiniger<br>- gebruiken in combinatie met<br>HCR-lijm zie blz. 102,<br>artikelnr. 1707 | pot 500      | 17080500<br>Artikelgroep: 19.01.05 |



## Bouten, moeren en sluitringen

| Artikelnr.  |   | Artikelnr.                                       |   |
|---|---|--|---|
| <b>5904</b><br>Bout<br>- elektrolytisch verzinkt<br>- kwaliteit: 8.8      |  | <b>59041</b><br>RVS Bout<br>- kwaliteit: A4      |   |
| <b>5905</b><br>Moer<br>- elektrolytisch verzinkt<br>- kwaliteit: 8.8      |  | <b>59051</b><br>RVS Moer<br>- kwaliteit: A4      |  |
| <b>5906</b><br>Sluitring<br>- elektrolytisch verzinkt<br>- kwaliteit: 8.8 |  | <b>59061</b><br>RVS Sluitring<br>- kwaliteit: A4 |  |

Voor afmetingen verwijzen wij u naar Groep 20 'Bevestigingsmaterialen'.



A large light blue rectangular area with horizontal ruling lines, intended for taking notes. The lines are evenly spaced and extend across the width of the page.

# Productgroep 03

PE Drukleidingen > PVC Drukleidingen > PP Drukleidingen  
> Afstandbediende afsluiters > C-PVC Programma >  
Blue-system programma > Binnen- en buitenriolering  
> Kabelbescherming en telecom > Milieu programma  
> Tanks > Folie en geotextielen > Halffabrikaten >  
RVS Programma > Malleable programma > Sanitair  
en verwarming > Metalen appendages en fittingen >  
Slangen en koppelingen > Pompen, filters en kabel  
> Lijm, reiniger en toebehoren > Bevestigingsmaterialen >  
Machines en gereedschappen

>> PP Drukleidingen

# Milder

— VEELZIJDIG IN LEIDINGSYSTEMEN —

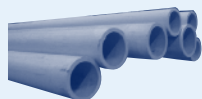
# 03.01 PP Drukbuīs

## PP Drukbuīs

• Lengten: standaard op 5 meter.

03

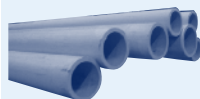
### 21107 PP Buis - SDR17,6



| Buitendiameter<br>x wanddikte in mm | Artikelnr. |
|-------------------------------------|------------|
| 20 x 1,8                            | 21107020   |
| 25 x 1,8                            | 21107025   |
| 32 x 1,8                            | 21107032   |
| 40 x 2,3                            | 21107040   |
| 50 x 2,9                            | 21107050   |
| 63 x 3,6                            | 21107063   |
| 75 x 4,3                            | 21107075   |
| 90 x 5,1                            | 21107090   |
| 110 x 6,3                           | 21107110   |
| 125 x 7,1                           | 21107125   |
| 140 x 8,0                           | 21107140   |
| 160 x 9,1                           | 21107160   |
| 180 x 10,2                          | 21107180   |
| 200 x 11,4                          | 21107200   |
| 225 x 12,8                          | 21107225   |
| 250 x 14,2                          | 21107250   |
| 280 x 15,9                          | 21107280   |
| 315 x 17,9                          | 21107315   |
| 355 x 20,1                          | 21107355   |
| 400 x 22,7                          | 21107400   |
| 450 x 25,5                          | 21107450   |
| 500 x 28,4                          | 21107500   |
| 560 x 31,7                          | 21107560   |
| 630 x 35,7                          | 21107630   |

Artikelgroep: 03.01.05

### 21108 PP Buis - SDR11



| Buitendiameter<br>x wanddikte in mm | Artikelnr. |
|-------------------------------------|------------|
| 10 x 1,8                            | 21108010   |
| 12 x 1,8                            | 21108012   |
| 16 x 1,8                            | 21108016   |
| 20 x 1,9                            | 21108020   |
| 25 x 2,3                            | 21108025   |
| 32 x 2,9                            | 21108032   |
| 40 x 3,7                            | 21108040   |
| 50 x 4,6                            | 21108050   |
| 63 x 5,8                            | 21108063   |
| 75 x 6,8                            | 21108075   |
| 90 x 8,2                            | 21108090   |
| 110 x 10,0                          | 21108110   |
| 125 x 11,4                          | 21108125   |
| 140 x 12,7                          | 21108140   |
| 160 x 14,6                          | 21108160   |
| 180 x 16,4                          | 21108180   |
| 200 x 18,2                          | 21108200   |
| 225 x 20,5                          | 21108225   |
| 250 x 22,7                          | 21108250   |
| 280 x 25,4                          | 21108280   |
| 315 x 28,6                          | 21108315   |
| 355 x 32,2                          | 21108355   |
| 400 x 36,3                          | 21108400   |
| 450 x 40,9                          | 21108450   |
| 500 x 45,4                          | 21108500   |

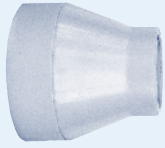
Artikelgroep: 03.01.05

## PP Drukfittingen SDR17,6

• Voor spiegellassen.

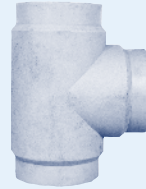
|                       | Afmeting in mm | Artikelnr. |
|-----------------------|----------------|------------|
| <b>674</b>            | 63 x 50        | 674063050  |
| <b>PP Verloopstuk</b> | 75 x 50        | 674075050  |
| - kort model          | 75 x 63        | 674075063  |
| - centrisch           | 90 x 50        | 674090050  |
| - SDR17,6             | 90 x 63        | 674090063  |
|                       | 90 x 75        | 674090075  |
|                       | 110 x 50       | 674110050  |
|                       | 110 x 63       | 674110063  |
|                       | 110 x 75       | 674110075  |
|                       | 110 x 90       | 674110090  |
|                       | 125 x 63       | 674125063  |
|                       | 125 x 75       | 674125075  |
|                       | 125 x 90       | 674125090  |
|                       | 125 x 110      | 674125110  |
|                       | 140 x 75       | 674140075  |
|                       | 140 x 90       | 674140090  |
|                       | 140 x 110      | 674140110  |
|                       | 140 x 125      | 674140125  |
|                       | 160 x 90       | 674160090  |
|                       | 160 x 110      | 674160110  |
|                       | 160 x 125      | 674160125  |
|                       | 160 x 140      | 674160140  |
|                       | 180 x 90       | 674180090  |
|                       | 180 x 110      | 674180110  |
|                       | 180 x 125      | 674180125  |
|                       | 180 x 140      | 674180140  |
|                       | 180 x 160      | 674180160  |
|                       | 200 x 140      | 674200140  |
|                       | 200 x 160      | 674200160  |
|                       | 200 x 180      | 674200180  |
|                       | 225 x 140      | 674225140  |
|                       | 225 x 160      | 674225160  |
|                       | 225 x 180      | 674225180  |
|                       | 225 x 200      | 674225200  |

Artikelgroep: 03.02.05



|                  | Afmeting in mm | Artikelnr. |
|------------------|----------------|------------|
| <b>679</b>       | 50             | 679050     |
| <b>PP T-stuk</b> | 63             | 679063     |
| - kort model     | 75             | 679075     |
| - SDR17,6        | 90             | 679090     |
|                  | 110            | 679110     |
|                  | 125            | 679125     |
|                  | 140            | 679140     |
|                  | 160            | 679160     |

Artikelgroep: 03.02.05



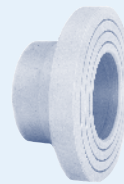
|                     | Afmeting in mm | Artikelnr. |
|---------------------|----------------|------------|
| <b>624</b>          | 50             | 624050     |
| <b>PP Bocht 90°</b> | 63             | 624063     |
| - r=d               | 75             | 624075     |
| - SDR17,6           | 90             | 624090     |
|                     | 110            | 624110     |
|                     | 125            | 624125     |
|                     | 140            | 624140     |
|                     | 160            | 624160     |
|                     | 200            | 624200     |

Artikelgroep: 03.02.05



|                        | Afmeting in mm | Artikelnr. |
|------------------------|----------------|------------|
| <b>684</b>             | 50             | 684050     |
| <b>PP Voorlaskraag</b> | 63             | 684063     |
| - kort model           | 75             | 684075     |
| - SDR17,6              | 90             | 684090     |
|                        | 110            | 684110     |
|                        | 125            | 684125     |
|                        | 140            | 684140     |
|                        | 160            | 684160     |
|                        | 180            | 684180     |
|                        | 200            | 684200     |
|                        | 225            | 684225     |
|                        | 250            | 684250     |
|                        | 280            | 684280     |
|                        | 315            | 684315     |
|                        | 355            | 684355     |
|                        | 400            | 684400     |
|                        | 500            | 684500     |
|                        | 630            | 684630     |

Artikelgroep: 03.02.05



|                     | Afmeting in mm | Artikelnr. |
|---------------------|----------------|------------|
| <b>694</b>          | 50             | 694050     |
| <b>PP Bocht 45°</b> | 63             | 694063     |
| - r=d               | 75             | 694075     |
| - SDR17,6           | 90             | 694090     |
|                     | 110            | 694110     |
|                     | 125            | 694125     |
|                     | 140            | 694140     |
|                     | 160            | 694160     |
|                     | 200            | 694200     |

Artikelgroep: 03.02.05



# 03.02 Fittingen voor PP drukleidingen

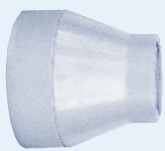
## PP Drukfittingen SDR11

- Voor spiegellassen.

03

|                       | Afmeting in mm | Artikelnr. |
|-----------------------|----------------|------------|
| <b>174</b>            | 25 x 20        | 174025020  |
| <b>PP Verloopstuk</b> | 32 x 20        | 174032020  |
| - kort model          | 32 x 25        | 174032025  |
| - centrisch           | 40 x 20        | 174040020  |
| - SDR11               | 40 x 25        | 174040025  |
|                       | 40 x 32        | 174040032  |
|                       | 50 x 25        | 174050025  |
|                       | 50 x 32        | 174050032  |
|                       | 50 x 40        | 174050040  |
|                       | 63 x 32        | 174063032  |
|                       | 63 x 40        | 174063040  |
|                       | 63 x 50        | 174063050  |
|                       | 75 x 32        | 174075032  |
|                       | 75 x 40        | 174075040  |
|                       | 75 x 50        | 174075050  |
|                       | 75 x 63        | 174075063  |
|                       | 90 x 50        | 174090050  |
|                       | 90 x 63        | 174090063  |
|                       | 90 x 75        | 174090075  |
|                       | 110 x 50       | 174110050  |
|                       | 110 x 63       | 174110063  |
|                       | 110 x 75       | 174110075  |
|                       | 110 x 90       | 174110090  |
|                       | 125 x 63       | 174125063  |
|                       | 125 x 75       | 174125075  |
|                       | 125 x 90       | 174125090  |
|                       | 125 x 110      | 174125110  |
|                       | 140 x 75       | 174140075  |
|                       | 140 x 90       | 174140090  |
|                       | 140 x 110      | 174140110  |
|                       | 140 x 125      | 174140125  |
|                       | 160 x 90       | 174160090  |
|                       | 160 x 110      | 174160110  |
|                       | 160 x 125      | 174160125  |
|                       | 160 x 140      | 174160140  |
|                       | 180 x 90       | 174180090  |
|                       | 180 x 110      | 174180110  |
|                       | 180 x 125      | 174180125  |
|                       | 180 x 140      | 174180140  |
|                       | 180 x 160      | 174180160  |
|                       | 200 x 140      | 174200140  |
|                       | 200 x 160      | 174200160  |
|                       | 200 x 180      | 174200180  |
|                       | 225 x 140      | 174225140  |
|                       | 225 x 160      | 174225160  |
|                       | 225 x 180      | 174225180  |
|                       | 225 x 200      | 174225200  |

Artikelgroep: 03.02.10



|                     | Afmeting in mm | Artikelnr. |
|---------------------|----------------|------------|
| <b>124</b>          | 20             | 124020     |
| <b>PP Bocht 90°</b> | 25             | 124025     |
| - r=d               | 32             | 124032     |
| - SDR11             | 40             | 124040     |
|                     | 50             | 124050     |
|                     | 63             | 124063     |
|                     | 75             | 124075     |
|                     | 90             | 124090     |
|                     | 110            | 124110     |
|                     | 125            | 124125     |
|                     | 140            | 124140     |
|                     | 160            | 124160     |
|                     | 200            | 124200     |
|                     | 225            | 124225     |

Artikelgroep: 03.02.10



|                     | Afmeting in mm | Artikelnr. |
|---------------------|----------------|------------|
| <b>194</b>          | 20             | 194020     |
| <b>PP Bocht 45°</b> | 25             | 194025     |
| - r=d               | 32             | 194032     |
| - SDR11             | 40             | 194040     |
|                     | 50             | 194050     |
|                     | 63             | 194063     |
|                     | 75             | 194075     |
|                     | 90             | 194090     |
|                     | 110            | 194110     |
|                     | 125            | 194125     |
|                     | 140            | 194140     |
|                     | 160            | 194160     |
|                     | 200            | 194200     |
|                     | 225            | 194225     |

Artikelgroep: 03.02.10



|                                  | Afmeting in mm | Artikelnr. |
|----------------------------------|----------------|------------|
| <b>134</b>                       | 32             | 134032     |
| <b>PP Bocht 90°</b>              | 40             | 134040     |
| - r=1,5d                         | 50             | 134050     |
| - naadloos uit buis<br>getrokken | 63             | 134063     |
| - SDR11                          | 75             | 134075     |
|                                  | 90             | 134090     |
|                                  | 110            | 134110     |
|                                  | 125            | 134125     |
|                                  | 140            | 134140     |
|                                  | 160            | 134160     |
|                                  | 180            | 134180     |
|                                  | 200            | 134200     |
|                                  | 225            | 134225     |
|                                  | 250            | 134250     |
|                                  | 280            | 134280     |
|                                  | 315            | 134315     |

Artikelgroep: 03.02.10



|                   | Afmeting in mm | Artikelnr. |
|-------------------|----------------|------------|
| <b>178</b>        | 32             | 178032     |
| <b>PP Eindkap</b> | 40             | 178040     |
| - SDR11           | 50             | 178050     |
|                   | 63             | 178063     |
|                   | 75             | 178075     |
|                   | 90             | 178090     |
|                   | 110            | 178110     |
|                   | 125            | 178125     |
|                   | 140            | 178140     |
|                   | 160            | 178160     |

Artikelgroep: 03.02.10



|                                  | Afmeting in mm | Artikelnr. |
|----------------------------------|----------------|------------|
| <b>164</b>                       | 32             | 164032     |
| <b>PP Bocht 45°</b>              | 40             | 164040     |
| - r=1,5d                         | 50             | 164050     |
| - naadloos uit buis<br>getrokken | 63             | 164063     |
| - SDR11                          | 75             | 164075     |
|                                  | 90             | 164090     |
|                                  | 110            | 164110     |
|                                  | 125            | 164125     |
|                                  | 140            | 164140     |
|                                  | 160            | 164160     |
|                                  | 180            | 164180     |
|                                  | 200            | 164200 ↗   |



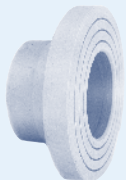
## PP Drukfittingen SDR11

|                    | Afmeting in mm | Artikelnr.             |
|--------------------|----------------|------------------------|
| <b>Vervolg 164</b> | 225            | 164225                 |
|                    | 250            | 164250                 |
|                    | 280            | 164280                 |
|                    | 315            | 164315                 |
|                    |                | Artikelgroep: 03.02.10 |

|   | Afmeting in mm | Artikelnr.             |
|---|----------------|------------------------|
| <b>179</b><br><b>PP T-stuk</b><br>- kort model<br>- SDR11 | 20             | 179020                 |
|   | 25             | 179025                 |
|   | 32             | 179032                 |
|   | 40             | 179040                 |
|   | 50             | 179050                 |
|   | 63             | 179063                 |
|   | 75             | 179075                 |
|   | 90             | 179090                 |
|   | 110            | 179110                 |
|   | 125            | 179125                 |
|   | 140            | 179140                 |
|   | 160            | 179160                 |
|   | 180            | 179180                 |
|   | 200            | 179200                 |
|   | 225            | 179225                 |
|   | 250            | 179250                 |
|   | 280            | 179280                 |
| 315   | 179315         |                        |
| 355   | 179355         |                        |
| 400   | 179400         |                        |
|   |                | Artikelgroep: 03.02.10 |



|   | Afmeting in mm | Artikelnr.             |
|---|----------------|------------------------|
| <b>184</b><br><b>PP Voorlaskraag</b><br>- kort model<br>- SDR11 | 20             | 184020                 |
|   | 25             | 184025                 |
|   | 32             | 184032                 |
|   | 40             | 184040                 |
|   | 50             | 184050                 |
|   | 63             | 184063                 |
|   | 75             | 184075                 |
|   | 90             | 184090                 |
|   | 110            | 184110                 |
|   | 125            | 184125                 |
|   | 140            | 184140                 |
|   | 160            | 184160                 |
|   | 180            | 184180                 |
|   | 200            | 184200                 |
|   | 225            | 184225                 |
|   | 250            | 184250                 |
|   | 280            | 184280                 |
| 315   | 184315         |                        |
| 355   | 184355         |                        |
| 400   | 184400         |                        |
| 500   | 184500         |                        |
|   |                | Artikelgroep: 03.02.10 |

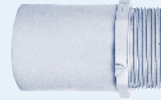


|  | Afmeting in mm | Artikelnr.             |
|--|----------------|------------------------|
| <b>245*</b><br><b>PP 3-Delige koppeling</b><br>- lange spie-einden<br>- EPDM O-ring<br>- SDR11 | 20*            | 245020                 |
|  | 25*            | 245025                 |
|  | 32*            | 245032                 |
|  | 40*            | 245040                 |
|  | 50*            | 245050                 |
|  | 63*            | 245063                 |
|  |                | Artikelgroep: 03.02.10 |



\* Verminderde drukbestendigheid max. PN8 water 20°C.

|   | Afmeting      | Artikelnr.             |
|---|---------------|------------------------|
| <b>254*</b><br><b>PP Puntstuk</b><br>- met buitendraad<br>- lang spie-eind<br>- SDR11 | 20 x 1/2" *   | 254020                 |
|   | 25 x 3/4" *   | 254025                 |
|   | 32 x 1" *     | 254032                 |
|   | 40 x 1 1/4" * | 254040                 |
|   | 50 x 1 1/2" * | 254050                 |
| 63 x 2" *   | 254063        |                        |
|   |               | Artikelgroep: 03.02.10 |



\* Verminderde drukbestendigheid max. PN8 water 20°C.

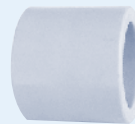
|   | Afmeting      | Artikelnr.             |
|---|---------------|------------------------|
| <b>265*</b><br><b>PP Schroeffbus</b><br>- met binnendraad<br>- lange spie-einden<br>- SDR11 | 20 x 1/2" *   | 265020012              |
|   | 25 x 3/4" *   | 265025034              |
|   | 32 x 1" *     | 265032100              |
|   | 40 x 1 1/4" * | 265040114              |
|   | 50 x 1 1/2" * | 265050112              |
| 63 x 2" *   | 265063200     |                        |
|   |               | Artikelgroep: 03.02.10 |



\* Verminderde drukbestendigheid max. PN8 water 20°C.

## PP Drukfittingen SDR11 voor moflas

|  | Afmeting in mm | Artikelnr. |
|--|----------------|------------|
| <b>775</b><br><b>PP Sok</b><br>- SDR11 | 16             | 775016     |
|  | 20             | 775020     |
|  | 25             | 775025     |
|  | 32             | 775032     |
|  | 40             | 775040     |
|  | 50             | 775050     |
|  | 63             | 775063     |
|  | 75             | 775075     |
|  | 90             | 775090     |
|  | 110            | 775110     |
|  |                |            |



|  | Afmeting in mm | Artikelnr.             |
|--|----------------|------------------------|
| <b>763</b><br><b>PP Eindkap</b><br>- SDR11 | 20             | 763020                 |
|  | 25             | 763025                 |
|  | 32             | 763032                 |
|  | 40             | 763040                 |
|  | 50             | 763050                 |
|  | 63             | 763063                 |
|  | 75             | 763075                 |
|  | 90             | 763090                 |
|  | 110            | 763110                 |
|  |                | Artikelgroep: 03.02.15 |



# 03.02 Fittingen voor PP drukleidingen

## PP Drukfittingen SDR11 voor moflas

03

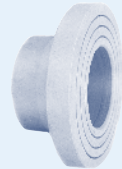
|                                      | Afmeting in mm | Artikelnr. |
|--------------------------------------|----------------|------------|
| <b>734</b><br>PP Knie 90°<br>- SDR11 | 16             | 734016     |
|                                      | 20             | 734020     |
|                                      | 25             | 734025     |
|                                      | 32             | 734032     |
|                                      | 40             | 734040     |
|                                      | 50             | 734050     |
|                                      | 63             | 734063     |
|                                      | 75             | 734075     |
|                                      | 90             | 734090     |
|                                      | 110            | 734110     |

Artikelgroep: 03.02.15



|                                      | Afmeting in mm | Artikelnr. |
|--------------------------------------|----------------|------------|
| <b>784</b><br>PP Kraagbus<br>- SDR11 | 20             | 784020     |
|                                      | 25             | 784025     |
|                                      | 32             | 784032     |
|                                      | 40             | 784040     |
|                                      | 50             | 784050     |
|                                      | 63             | 784063     |
|                                      | 75             | 784075     |
|                                      | 90             | 784090     |
|                                      | 110            | 784110     |

Artikelgroep: 03.02.15



|                                      | Afmeting in mm | Artikelnr. |
|--------------------------------------|----------------|------------|
| <b>764</b><br>PP Knie 45°<br>- SDR11 | 16             | 764016     |
|                                      | 20             | 764020     |
|                                      | 25             | 764025     |
|                                      | 32             | 764032     |
|                                      | 40             | 764040     |
|                                      | 50             | 764050     |
|                                      | 63             | 764063     |
|                                      | 75             | 764075     |
|                                      | 90             | 764090     |
|                                      | 110            | 764110     |

Artikelgroep: 03.02.15



|   | Afmeting in mm | Artikelnr. |
|---|----------------|------------|
| <b>766*</b><br>PP Koppeling<br>- met EPDM O-ring<br>- SDR11 | 20*            | 766020     |
|   | 25*            | 766025     |
|   | 32*            | 766032     |
|   | 40*            | 766040     |
|   | 50*            | 766050     |
|   | 63*            | 766063     |

Artikelgroep: 03.02.15



\* Verminderde drukbestendigheid max. PN8 water 20°C.

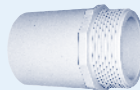
|  | Afmeting in mm | Artikelnr. |
|--|----------------|------------|
| <b>776</b><br>PP Verloopsok<br>- SDR11 | 25 x 20        | 776025020  |
|  | 32 x 20        | 776032020  |
|  | 32 x 25        | 776032025  |
|  | 40 x 20        | 776040020  |
|  | 40 x 25        | 776040025  |
|  | 40 x 32        | 776040032  |
|  | 50 x 20        | 776050020  |
|  | 50 x 25        | 776050025  |
|  | 50 x 32        | 776050032  |
|  | 50 x 40        | 776050040  |
|  | 63 x 25        | 776063025  |
|  | 63 x 32        | 776063032  |
|  | 63 x 40        | 776063040  |
|  | 63 x 50        | 776063050  |
|  | 75 x 63        | 776075063  |
|  | 90 x 63        | 776090063  |
|  | 90 x 75        | 776090075  |
|  | 110 x 90       | 776110090  |

Artikelgroep: 03.02.15



|   | Afmeting      | Artikelnr. |
|---|---------------|------------|
| <b>773*</b><br>PP Puntstuk<br>- spie x buitendraad<br>- SDR11 | 20 x 1/2" *   | 773020012  |
|   | 25 x 3/4" *   | 773025034  |
|   | 32 x 1" *     | 773032100  |
|   | 40 x 1 1/4" * | 773040114  |
|   | 50 x 1 1/2" * | 773050112  |
|   | 63 x 2" *     | 773063200  |

Artikelgroep: 03.02.15



\* Verminderde drukbestendigheid max. PN8 water 20°C.

|  | Afmeting in mm | Artikelnr. |
|--|----------------|------------|
| <b>779</b><br>PP T-stuk 90°<br>- SDR11 | 20             | 779020     |
|  | 25             | 779025     |
|  | 32             | 779032     |
|  | 40             | 779040     |
|  | 50             | 779050     |
|  | 63             | 779063     |
|  | 75             | 779075     |
|  | 110            | 779110     |

Artikelgroep: 03.02.15



|  | Afmeting      | Artikelnr. |
|--|---------------|------------|
| <b>772*</b><br>PP Schroefbus<br>- mof x binnendraad<br>- SDR11 | 20 x 1/2" *   | 772020012  |
|  | 25 x 3/4" *   | 772025034  |
|  | 32 x 1" *     | 772032100  |
|  | 40 x 1 1/4" * | 772040114  |
|  | 50 x 1 1/2" * | 772050112  |
|  | 63 x 2" *     | 772063200  |

Artikelgroep: 03.02.15



\* Verminderde drukbestendigheid max. PN8 water 20°C.

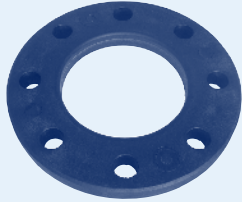
## PP Flenzen voor PP leidingen

- Voor afwijkende uitvoeringen of diameters kunt u contact opnemen met onze verkoopmedewerkers.

|                           | Afmeting<br>in mm/DN | Geboord/drukklass<br>PN | øk<br>in mm | ød6<br>in mm | b<br>in mm | n x ød2<br>in mm | Artikelnr. |
|---------------------------|----------------------|-------------------------|-------------|--------------|------------|------------------|------------|
| <b>5903</b>               | 20/15                | 10/16                   | 65          | 28           | 12         | 4 x 14           | 5903020    |
| <b>PP Overschuifflens</b> | 25/20                | 10/16                   | 75          | 34           | 14         | 4 x 14           | 5903025    |
| - met stalen kern         | 32/25                | 10/16                   | 85          | 42           | 14         | 4 x 14           | 5903032    |
| - voor PE/PP kraagbussen  | 40/32                | 10/16                   | 100         | 51           | 16         | 4 x 18           | 5903040    |
| - volgens DIN2501         | 50/40                | 10/16                   | 110         | 62           | 18         | 4 x 18           | 5903050    |
|                           | 63/50                | 10/16                   | 125         | 78           | 18         | 4 x 18           | 5903063    |
|                           | 75/65                | 10/16                   | 145         | 92           | 18         | 4 x 18           | 5903075    |
|                           | 90/80                | 10/16                   | 160         | 108          | 18         | 8 x 18           | 5903090    |
|                           | 110/100              | 10/16                   | 180         | 128          | 18         | 8 x 18           | 5903110    |
|                           | 125/100              | 10/16                   | 180         | 135          | 18         | 8 x 18           | 5903125    |
|                           | 140/125              | 10/16                   | 210         | 158          | 24         | 8 x 18           | 5903140    |
|                           | 160/150              | 10/16                   | 240         | 178          | 24         | 8 x 22           | 5903160    |
|                           | 180/150              | 10/16                   | 240         | 188          | 24         | 8 x 22           | 5903180    |
|                           | 200/200              | 10                      | 295         | 235          | 24         | 8 x 22           | 5903200    |
|                           | 200/200              | 16                      | 295         | 235          | 24         | 12 x 22          | 590320016  |
|                           | 225/200              | 10                      | 295         | 238          | 24         | 8 x 22           | 5903225    |
|                           | 225/200              | 16                      | 295         | 238          | 24         | 12 x 22          | 590322516  |
|                           | 250/250              | 10                      | 350         | 288          | 31         | 12 x 22          | 5903250    |
|                           | 250/250              | 16                      | 355         | 288          | 30         | 12 x 26          | 590325016  |
|                           | 280/250              | 10                      | 350         | 294          | 34         | 12 x 22          | 5903280    |
|                           | 280/250              | 16                      | 355         | 294          | 30         | 12 x 26          | 590328016  |
|                           | 315/300              | 10                      | 400         | 338          | 34         | 12 x 22          | 5903315    |
|                           | 315/300              | 16                      | 410         | 338          | 34         | 12 x 26          | 590331516  |
|                           | 355/350              | 10                      | 460         | 376          | 39         | 16 x 22          | 5903355    |
|                           | 355/350              | 16                      | 470         | 376          | 42         | 16 x 26          | 590335516  |
|                           | 400/400              | 10                      | 515         | 430          | 43         | 16 x 26          | 5903400    |
|                           | 400/400              | 16                      | 525         | 430          | 46         | 16 x 30          | 590340016  |
|                           | 450/500              | 10                      | 620         | 517          | 54         | 20 x 26          | 5903450    |
|                           | 500/500              | 10                      | 620         | 533          | 54         | 20 x 26          | 5903500    |
|                           | 560/600              | 10                      | 725         | 618          | 64         | 20 x 30          | 5903560    |
|                           | 630/600              | 10                      | 725         | 645          | 58         | 20 x 30          | 5903630    |

Artikelgr.: 01.02.50

øk = steekcirkel  
ød6 = binnenmaat  
b = dikte flens  
n = aantal gaten  
ød2 = diameter gat

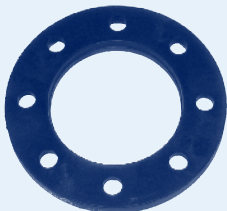


03

|                                | Afmeting    | Geboord/drukklass<br>PN/ lbs | øk<br>in mm | b<br>in mm | n x ød2<br>in mm | Artikelnr. |
|--------------------------------|-------------|------------------------------|-------------|------------|------------------|------------|
| <b>5907</b>                    | 20 (1/2")   | 150                          | 60,3        | 12         | 4 x 15,9         | 5907020    |
| <b>PP Overschuifflens ANSI</b> | 25 (3/4")   | 150                          | 69,8        | 12         | 4 x 15,9         | 5907025    |
| - met stalen kern              | 32 (1")     | 150                          | 79,4        | 16         | 4 x 15,9         | 5907032    |
| - voor PE/PP kraagbussen       | 40 (1 1/4") | 150                          | 88,9        | 16         | 4 x 15,9         | 5907040    |
| - volgens B16.5                | 50 (1 1/2") | 150                          | 98,4        | 18         | 4 x 15,9         | 5907050    |
|                                | 63 (2")     | 150                          | 120,6       | 18         | 4 x 20           | 5907063    |
|                                | 75 (2 1/2") | 150                          | 139,7       | 18         | 4 x 19           | 5907075    |
|                                | 90 (3")     | 150                          | 152,4       | 18         | 4 x 19           | 5907090    |
|                                | 110 (4")    | 150                          | 190,5       | 18         | 4 x 19           | 5907110    |
|                                | 160 (6")    | 150                          | 240,0       | 24         | 8 x 22           | 5907160    |
|                                | 200 (8")    | 150                          | 295,0       | 24         | 8 x 22           | 5907200    |
|                                | 250 (10")   | 150                          | 362,0       | 30         | 8 x 25           | 5907250    |
|                                | 315 (12")   | 150                          | 431,8       | 34         | 12 x 25,4        | 5907315    |
|                                | 355 (14")   | 150                          | 476,2       | 42         | 12 x 28,6        | 5907355    |
|                                | 400 (16")   | 150                          | 539,7       | 44         | 12 x 28,6        | 5907400    |

Artikelgr.: 01.02.50

øk = steekcirkel  
b = dikte flens  
n = aantal gaten  
ød2 = diameter gat





## 03.02 Fittingen voor PP drukleidingen

### PP Flenzen voor PP leidingen

03

#### 5902

##### PP Blindflens

- met stalen kern
- voor PE/PP kraagbussen
- volgens DIN2501



| Afmeting d | Geboord/drukklasse PN | øk in mm | b in mm | n x ød2 in mm | Artikelnr. |
|------------|-----------------------|----------|---------|---------------|------------|
| 20         | 10/16                 | 65       | 12      | 4 x 14        | 5902020    |
| 25         | 10/16                 | 75       | 12      | 4 x 14        | 5902025    |
| 32         | 10/16                 | 85       | 16      | 4 x 14        | 5902032    |
| 40         | 10/16                 | 100      | 18      | 4 x 18        | 5902040    |
| 50         | 10/16                 | 110      | 18      | 4 x 18        | 5902050    |
| 63         | 10/16                 | 125      | 18      | 4 x 18        | 5902063    |
| 75         | 10/16                 | 145      | 18      | 4 x 18        | 5902075    |
| 90         | 10/16                 | 160      | 20      | 8 x 18        | 5902090    |
| 110/125    | 10/16                 | 180      | 20      | 8 x 18        | 5902110    |
| 140        | 10/16                 | 210      | 24      | 8 x 18        | 5902140    |
| 160/180    | 10/16                 | 240      | 24      | 8 x 22        | 5902160    |
| 200/225    | 10                    | 295      | 24      | 8 x 22        | 5902200    |
| 250        | 10                    | 350      | 30      | 12 x 22       | 5902250    |
| 280        | 10                    | 350      | 30      | 12 x 22       | 5902280    |
| 315        | 10                    | 400      | 34      | 12 x 22       | 5902315    |
| 355        | 10                    | 460      | 39      | 16 x 22       | 5902355    |
| 400        | 10                    | 515      | 44      | 16 x 26       | 5902400    |

Artikelgr.: 01.02.50

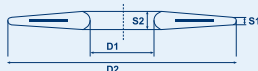
- øk = steekcirkel  
 b = dikte flens  
 n = aantal gaten  
 ød2 = diameter gat

### PSI Pakkingen

#### Fig. 192

##### EPDM Pakking met staalinlage

- voor water



| Afmeting | Drukklasse | D1xD2 / S1xS2 in mm | Geschikt voor                     | Artikelnr. |
|----------|------------|---------------------|-----------------------------------|------------|
| DN15     | PN10/40    | 22 x 51 / 3-4       | 20mm PE/PVC/staal                 | 100802462  |
| DN20     | PN10/40    | 27 x 61 / 3-4       | 25mm PE/PVC/staal                 | 100803463  |
| DN25     | PN10/40    | 34 x 71 / 3-4       | 32mm PE/PVC/staal                 | 100801464  |
| DN32     | PN10/40    | 43 x 82 / 3-4       | 40mm PE/PVC/staal                 | 100803418  |
| DN40     | PN10/40    | 49 x 92 / 3-4       | 50mm PE/PVC/staal                 | 100803439  |
| DN50     | PN10/40    | 61 x 107 / 4-5      | 63mm PE/PVC/staal                 | 100803462  |
| DN65     | PN10/40    | 77 x 127 / 4-5      | 75mm PE/PVC/staal                 | 100803483  |
| DN80     | PN10/40    | 89 x 142 / 3-4      | 90mm PE/PVC/staal                 | 100801465  |
| DN100    | PN10/16    | 115 x 162 / 4-5     | 110mm PE/PVC/staal                | 100801466  |
| DN100    | PN25/40    | 115 x 168 / 5-6     | 125mm PE/staal                    | 100801488  |
| DN125    | PN10/16    | 141 x 192 / 4-5     | 140mm PE/PVC/staal                | 100803491  |
| DN150    | PN10/16    | 169 x 218 / 4-5     | 160mm PE/PVC/staal-180mm PE/Staal | 100803495  |
| DN200    | PN10/16    | 220 x 273 / 5-6     | 200mm / 225mm PE/PVC/staal        | 100803499  |
| DN250    | PN10       | 273 x 328 / 5-6     | 250mm / 280mm PE/PVC/staal        | 100803504  |
| DN250    | PN16       | 273 x 329 / 6-7     | 250mm / 280mm PE/PVC/staal        | 100803505  |
| DN300    | PN10       | 324 x 378 / 5-6     | 315mm PE/PVC/staal                | 100803510  |
| DN300    | PN16       | 324 x 384 / 6-7     | 315mm PE/staal                    | 100803511  |
| DN350    | PN10       | 356 x 438 / 6-7     | 355mm PVC                         | 100803515  |
| DN350    | PN16       | 368 x 445 / 7-9     | 355mm PE/staal                    | 100801516  |
| DN400    | PN10       | 407 x 489 / 6-7     | 400mm PE/PVC/staal                | 100903520  |
| DN400    | PN16       | 407 x 495 / 7-9     | 400mm PE/staal                    | 100903521  |
| DN450    | PN10       | 470 x 540 / 7-9     | 450mm PE/staal                    | 100903525  |
| DN450    | PN16       | 470 x 557 / 7-9     | 450mm PE/staal                    | 100901526  |
| DN500    | PN10       | 508 x 594 / 6-7     | 450mm / 500mm PE/staal            | 100901474  |
| DN500    | PN16       | 508 x 617 / 7-9     | 450mm / 500mm PE/staal            | 100903532  |
| DN600    | PN10       | 610 x 695 / 6-7     | 630mm PE/staal                    | 100901475  |
| DN700    | PN10       | 712 x 810 / 7-8     | 710mm PE/staal                    | 100901476  |
| DN800    | PN10       | 813 x 917 / 7-8     | 800mm PE/staal                    | 100901477  |
| DN900    | PN10       | 915 x 1017/7-8      | 900mm PE                          | 100901548  |
| DN1000   | PN10       | 1016 x 1124/7-8     | 1000mm PE                         | 100901479  |

Artikelgroep: 16.02.05

PN6 flenzen zijn op aanvraag leverbaar.

## PSI Pakkingen

03

**Fig. 195**  
EPDM Pakking  
- verstelbaar tot 8°



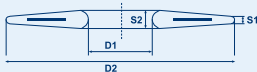
| DN  | Drukklasse | Dikte in mm<br>(min x max) | Maat bout x<br>lengte in mm | Artikelnr. |
|-----|------------|----------------------------|-----------------------------|------------|
| 32  | PN10/40    | 9 x 20                     | M14 x 90                    | 100804001  |
| 40  | PN10/40    | 9 x 22                     | M14 x 90                    | 100804002  |
| 50  | PN10/40    | 9 x 24                     | M14 x 100                   | 100804003  |
| 65  | PN10/40    | 9 x 26                     | M14 x 100                   | 100804004  |
| 80  | PN10/40    | 14 x 30                    | M14 x 100                   | 100804005  |
| 100 | PN10/16    | 14 x 30                    | M14 x 100                   | 100804006  |
| 100 | PN25/40    | 14 x 33                    | M18 x 110                   | 100804007  |
| 125 | PN10/16    | 14 x 36                    | M14 x 100                   | 100804110  |
| 150 | PN10/16    | 14 x 39                    | M18 x 110                   | 100804008  |
| 150 | PN25/40    | 14 x 39                    | M22 x 130                   | 100804009  |
| 200 | PN10/16    | 15 x 50                    | M18 x 120                   | 100804010  |
| 200 | PN40       | 15 x 50                    | M24 x 160                   | 100804011  |
| 250 | PN10/16    | 16 x 59                    | M18 x 140                   | 100804012  |
| 250 | PN40       | 16 x 59                    | M27 x 170                   | 100804013  |
| 300 | PN10       | 22 x 68                    | M18 x 150                   | 100804014  |
| 350 | PN10       | 22 x 68                    | M18 x 150                   | 100804015  |
| 400 | PN10       | 22 x 74                    | M22 x 160                   | 100804016  |
| 500 | PN10       | 23 x 79                    | M22 x 180                   | 100804017  |

Artikelgroep: 16.02.05

| Afmeting | Drukklasse | D1xD2 / S1xS2<br>in mm | Geschikt voor                     | Artikelnr. |
|----------|------------|------------------------|-----------------------------------|------------|
| DN15     | PN10/40    | 22 x 51 / 3-4          | 20mm PE/PVC/staal                 | 100801287  |
| DN20     | PN10/40    | 27 x 61 / 3-4          | 25mm PE/PVC/staal                 | 100801288  |
| DN25     | PN10/40    | 34 x 71 / 3-4          | 32mm PE/PVC/staal                 | 100801289  |
| DN32     | PN10/40    | 43 x 82 / 3-4          | 40mm PE/PVC/staal                 | 100903242  |
| DN40     | PN10/40    | 49 x 92 / 3-4          | 50mm PE/PVC/staal                 | 100803263  |
| DN50     | PN10/40    | 61 x 107 / 4-5         | 63mm PE/PVC/staal                 | 100803286  |
| DN65     | PN10/40    | 77 x 127 / 4-5         | 75mm PE/PVC/staal                 | 100803308  |
| DN80     | PN10/40    | 89 x 142 / 3-4         | 90mm PE/PVC/staal                 | 100803309  |
| DN100    | PN10/16    | 115 x 162 / 4-5        | 110mm PE/PVC/staal                | 100803312  |
| DN100    | PN25/40    | 115 x 168 / 5-6        | 125mm PE                          | 100803313  |
| DN125    | PN10/16    | 141 x 192 / 4-5        | 140mm PE/PVC/staal                | 100803316  |
| DN150    | PN10/16    | 169 x 218 / 4-5        | 160mm PE/PVC/staal-180mm PE/staal | 100803320  |
| DN200    | PN10/16    | 220 x 273 / 5-6        | 200mm / 225mm PE/PVC/staal        | 100803324  |
| DN250    | PN10       | 273 x 328 / 5-6        | 250mm / 280mm PE/PVC/staal        | 100803329  |
| DN250    | PN16       | 273 x 329 / 6-7        | 250mm / 280mm PE/PVC/staal        | 100803330  |
| DN300    | PN10       | 324 x 378 / 5-6        | 315mm PE/PVC/staal                | 100803335  |
| DN300    | PN16       | 324 x 384 / 6-7        | 315mm PE/staal                    | 100803336  |
| DN350    | PN10       | 356 x 438 / 6-7        | 355mm PVC                         | 100801297  |
| DN350    | PN16       | 368 x 445 / 7-9        | 355mm PE                          | 100801341  |
| DN400    | PN10       | 407 x 489 / 6-7        | 400mm PE/PVC/staal                | 100903345  |
| DN400    | PN16       | 407 x 495 / 7-9        | 400mm PE/staal                    | 100903346  |
| DN450    | PN10       | 470 x 540 / 7-9        | 450mm PE                          | 100903350  |
| DN450    | PN16       | 470 x 557 / 7-9        | 450mm PE                          | 100901351  |
| DN500    | PN10       | 508 x 594 / 6-7        | 450mm / 500mm PE/staal            | 100903356  |
| DN500    | PN16       | 508 x 617 / 7-9        | 450mm / 500mm PE/staal            | 100903358  |
| DN600    | PN10       | 610 x 695 / 6-7        | 630mm PE/staal                    | 100903362  |
| DN700    | PN10       | 712 x 810 / 7-8        | 710mm PE/staal                    | 100903366  |
| DN800    | PN10       | 813 x 917 / 7-8        | 800mm PE                          | 100901302  |
| DN900    | PN10       | 915 x 1017 / 7-8       | 900mm PE                          | 100901374  |
| DN1000   | PN10       | 1016 x 1124 / 7-8      | 1000mm PE                         | 100901304  |

Artikelgroep: 16.02.05

**Fig. 205**  
NBR Pakking  
met staalinlage  
- voor water



Voor afdichtingen en Petro-band verwijzen wij u naar Groep 16 'PSI Pakkingen, afdichtingen en Petro-band'.

# 03.03 Afsluiters voor PP drukleidingen

## PP Afsluiters

- Onderstaande afsluiters zijn geschikt voor PP en PE leidingen.
- Voor PE leidingen altijd een spie-laseind toepassen.

03

### 1220

#### PE Spie-laseind

- voor het monteren van PP afsluiters tussen PE leidingen
- kort model voor spiegelglas\*



| Afmeting in mm | Artikelnr. |
|----------------|------------|
| 16             | 1220016    |
| 20             | 1220020    |
| 25             | 1220025    |
| 32             | 1220032    |
| 40             | 1220040    |
| 50             | 1220050    |
| 63             | 1220063    |
| 75             | 1220075    |
| 90             | 1220090    |
| 110            | 1220110    |

Artikelgroep: 03.03.05

\* Verlengen van PE spie-laseind voor elektrolas is mogelijk tegen een meerprijs.

### 1225

#### PP Kogelkraan

- PP spie-laseinden voor spiegelglasverbindingen
- FPM (viton) afdichting\*
- met veiligheidshendel



| Afmeting in mm | Artikelnr. |
|----------------|------------|
| 16             | 1225016    |
| 20             | 1225020    |
| 25             | 1225025    |
| 32             | 1225032    |
| 40             | 1225040    |
| 50             | 1225050    |
| 63             | 1225063    |
| 75             | 1225075    |
| 90             | 1225090    |
| 110            | 1225110    |

Artikelgroep: 03.03.05

\* Artikelnr. 1232: PP Kogelkraan met EPDM afdichting.

### 1231

#### PP Moflas kogelkraan

- voor moflassen
- EPDM afdichting\*



| Afmeting in mm | Artikelnr. |
|----------------|------------|
| 16             | 1231016    |
| 20             | 1231020    |
| 25             | 1231025    |
| 32             | 1231032    |
| 40             | 1231040    |
| 50             | 1231050    |
| 63             | 1231063    |
| 75             | 1231075    |
| 90             | 1231090    |
| 110            | 1231110    |

Artikelgroep: 03.03.05

\* Artikelnr. 1230: PP Moflas kogelkraan met FPM (viton) afdichting.

### 1226

#### PP Membraanafsluiter

- PP spie-laseinden voor spiegelglasverbindingen
- EPDM membraan

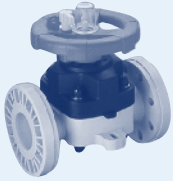


| Afmeting in mm | Artikelnr. |
|----------------|------------|
| 20             | 1226020    |
| 25             | 1226025    |
| 32             | 1226032    |
| 40             | 1226040    |
| 50             | 1226050    |
| 63             | 1226063    |
| 75             | 1226075    |
| 90             | 1226090    |
| 110            | 1226110    |

Artikelgroep: 03.03.05

## PP Afsluiters

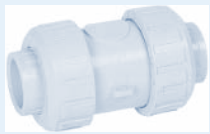
|   | Afmeting    | Artikelnr.             |
|---|-------------|------------------------|
| <b>1227</b><br><b>PP Membraanafsluiter</b><br>- flensaansluiting<br>- EPDM membraan | 20 (1/2")   | 1227020                |
|   | 25 (3/4")   | 1227025                |
|   | 32 (1")     | 1227032                |
|   | 40 (1 1/4") | 1227040                |
|   | 50 (1 1/2") | 1227050                |
|   | 63 (2")     | 1227063                |
|   | 75 (2 1/2") | 1227075                |
|   | 90 (3")     | 1227090                |
|   | 110 (4")    | 1227110                |
|   | 125 (5")    | 1227125                |
|   |             | Artikelgroep: 03.03.05 |



|  | Afmeting in mm | DN    | Doorlaat | Artikelnr. |
|--|----------------|-------|----------|------------|
| <b>6308</b><br><b>PP Terugslagklep</b> | 63             | DN50  | 32       | 6308063    |
|  | 75             | DN65  | 40       | 6308075    |
|  | 90             | DN80  | 52       | 6308090    |
|  | 110            | DN100 | 70       | 6308110    |
|  | 125/140        | DN125 | 92       | 6308125    |
|  | 160            | DN150 | 112      | 6308160    |
|  | 200/225        | DN200 | 150      | 6308200    |
|  | 250/280        | DN250 | 190      | 6308250    |
|  | 315            | DN300 | 216      | 6308315    |
|  |                |       |          |            |



|   | Afmeting in mm | Artikelnr.             |
|---|----------------|------------------------|
| <b>1228</b><br><b>PP Terugslagklep</b><br>- veerbelast<br>- PP spie-laseinden voor spiegelglasverbindingen<br>- FPM (viton) afdichting*<br>- veer is met PTFE bekleed | 16             | 1228016                |
|   | 20             | 1228020                |
|   | 25             | 1228025                |
|   | 32             | 1228032                |
|   | 40             | 1228040                |
|   | 50             | 1228050                |
|   | 63             | 1228063                |
|   | 75             | 1228075                |
|   | 90             | 1228090                |
|   | 110            | 1228110                |
|   |                | Artikelgroep: 03.03.05 |



\* Artikelnr. 1233: PP Terugslagklep met EPDM afdichting.

|   | Afmeting     | Artikelnr.             |
|---|--------------|------------------------|
| <b>1229</b><br><b>PP Vlinderklep</b><br>- FPM (viton) afdichting*<br>- met veiligheidshendel<br>- zware industrieelheid | 90 (3")      | 1229090                |
|   | 110 (4")     | 1229110                |
|   | 125/140 (5") | 1229125                |
|   | 160 (6")     | 1229160                |
|   | 200/225 (8") | 1229200                |
|   |              | Artikelgroep: 03.03.05 |



\* Artikelnr. 1235: PP Vlinderklep met EPDM afdichting.

## 03.04 Toebehoren voor PP drukleidingen

### Reiniger



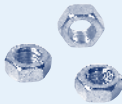
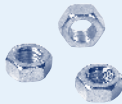


|  | Inhoud in ml | Artikelnr.                            |
|--|--------------|---------------------------------------|
| <b>1711</b><br><b>PE Reiniger</b><br>- voor het reinigen van PE/PP | fles 1000    | 17111000<br>Artikelgroep:<br>19.01.05 |



|   | Inhoud             | Artikelnr.                         |
|---|--------------------|------------------------------------|
| <b>17111</b><br><b>Reinigingsdoekjes</b><br>- voor het reinigen van PE/PP | flacon à 100 stuks | 17110001<br>Artikelgroep: 19.01.05 |



### Bouten, moeren en sluitringen

| Artikelnr.   |   | Artikelnr.  |  |
|--|---|---|--|
| <b>5904</b><br><b>Bout</b><br>- elektrolytisch verzinkt<br>- kwaliteit: 8.8      |  | <b>59041</b><br><b>RVS Bout</b><br>- kwaliteit: A4      |  |
| <b>5905</b><br><b>Moer</b><br>- elektrolytisch verzinkt<br>- kwaliteit: 8.8      |  | <b>59051</b><br><b>RVS Moer</b><br>- kwaliteit: A4      |  |
| <b>5906</b><br><b>Sluitring</b><br>- elektrolytisch verzinkt<br>- kwaliteit: 8.8 |  | <b>59061</b><br><b>RVS Sluitring</b><br>- kwaliteit: A4 |  |

Voor afmetingen verwijzen wij u naar Groep 20 'Bevestigingsmaterialen'.

# Productgroep 04

PE Drukleidingen > PVC Drukleidingen > PP Drukleidingen  
> Afstandbediende afsluiters > C-PVC Programma >  
Blue-system programma > Binnen- en buitenriolering  
> Kabelbescherming en telecom > Milieu programma  
> Tanks > Folie en geotextielen > Halffabrikaten >  
RVS Programma > Malleable programma > Sanitair  
en verwarming > Metalen appendages en fittingen >  
Slangen en koppelingen > Pompen, filters en kabel  
> Lijm, reiniger en toebehoren > Bevestigingsmaterialen >  
Machines en gereedschappen

>> Afstandbediende afsluiters

# Milder

— VEELZIJDIG IN LEIDINGSYSTEMEN —

# Afstandbediende afsluiters

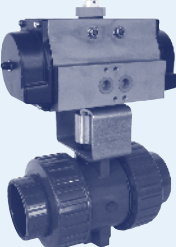
- In deze groep treft u afstandbediende afsluiters aan van kunststof en metaal.
- Voor technische specificaties kunt u contact opnemen met onze verkoopmedewerkers.
- Indien u op zoek bent naar een afstandbediende afsluiter die u niet in deze productgroep aantreft, neem dan contact op met onze afdeling verkoop. Wij helpen u graag verder.

## 04.01 Pneumatisch bediende afsluiters

### Pneumatisch bediende kogelkranen

04

|  | Afmeting in mm | Artikelnr.             |
|--|----------------|------------------------|
| <b>7100</b><br><b>PVC Kogelkraan</b><br>- met pneumatische aandrijving<br>- dubbelwerkend* | 32             | 7100032                |
|  | 40             | 7100040                |
|  | 50             | 7100050                |
|  | 63             | 7100063                |
|  | 75             | 7100075                |
|  | 90             | 7100090                |
|  | 110            | 7100110                |
|  |                | Artikelgroep: 04.01.05 |



\* Artikelnr. 7101: PVC kogelkraan enkelwerkend.

### Pneumatisch bediende vlinderkleppen

|   | Afmeting in mm | Artikelnr. |
|---|----------------|------------|
| <b>6326</b><br><b>PVC Vlinderklep</b><br>- met pneumatische aandrijving<br>- dubbelwerkend* | 75             | 6326075    |
|   | 90             | 6326090    |
|   | 110            | 6326110    |
|   | 125/140        | 6326125    |
|   | 160            | 6326160    |
|   | 200            | 6326200    |

Artikelgroep: 04.01.10



\* Artikelnr. 6327: PVC Vlinderklep enkelwerkend.

|   | Afmeting      | Artikelnr. |
|---|---------------|------------|
| <b>2870</b><br><b>Metalen vlinderklep</b><br>- met pneumatische aandrijving<br>- dubbelwerkend*<br>- vlinder: RVS AISI 316<br>- huis: GG25 Rilsan | DN50 (2")     | 2870050    |
|   | DN65 (2 1/2") | 2870065    |
|   | DN80 (3")     | 2870080    |
|   | DN100 (4")    | 2870100    |
|   | DN125 (5")    | 2870125    |
|   | DN150 (6")    | 2870150    |
|   | DN200 (8")    | 2870200    |
|   | DN250 (10")   | 2870250    |
|   | DN300 (12")   | 2870300    |


Artikelgroep: 04.01.10



\* Artikelnr. 2760: Metalen vlinderklep enkelwerkend.

## Pneumatisch bediende membraanafsluiters


|                                    | Afmeting in mm | Doorlaat DN | Artikelnr. |
|------------------------------------|----------------|-------------|------------|
| <b>485</b>                         | 20             | 15          | 485020     |
| <b>PVC 2-Weg membraanafsluiter</b> | 25             | 20          | 485025     |
| - EPDM membraan                    | 32             | 25          | 485032     |
| - normaal gesloten                 | 40             | 32          | 485040     |
|                                    | 50             | 40          | 485050     |
|                                    | 63             | 50          | 485063     |
|                                    | 75             | 65          | 485075     |
|                                    | 90             | 80          | 485090     |



Artikelgroep: 04.01.15

04

|                              | Afmeting in mm | Doorlaat DN | Artikelnr. |
|------------------------------|----------------|-------------|------------|
| <b>1480</b>                  | 20             | 15          | 1480020    |
| <b>PVC Membraanafsluiter</b> | 25             | 20          | 1480025    |
| - EPDM membraan              | 32             | 25          | 1480032    |
| - normaal geopend            | 40             | 32          | 1480040    |
|                              | 50             | 40          | 1480050    |
|                              | 63             | 50          | 1480063    |



Artikelgroep: 04.01.15

Artikelnr. 14801: Membraan voor artikelnr. 1480.

Bent u op zoek naar een PP pneumatisch bediende afsluiter, neem dan contact op met onze afdeling verkoop.



# 04.02 Elektrisch bediende afsluiters

## Elektrisch bediende kogelkranen

• Voor kabel verwijzen wij u naar Groep 18.

|   | Afmeting in mm | Artikelnr. |
|---|----------------|------------|
| <b>1902</b><br><b>PVC Kogelkraan</b><br>- met elektrische<br>aandrijving 24V* | 20             | 1902020    |
|   | 25             | 1902025    |
|   | 32             | 1902032    |
|   | 40             | 1902040    |
|   | 50             | 1902050    |
|   | 63             | 1902063    |
|   | 75             | 1902075    |
|   | 90             | 1902090    |
|   | 110            | 1902110    |
|   |                |            |



\* Artikelnr. 19021: PVC Kogelkraan 230V.

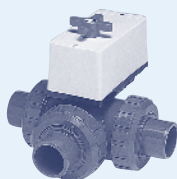
## Elektrisch bediende vlinderkleppen

|  | Afmeting in mm | Artikelnr. |                        |
|--|----------------|------------|------------------------|
| <b>6320</b><br><b>PVC Vlinderklep</b><br>- met elektrische<br>aandrijving 24V* | 63             | 6320063    |                        |
|  | 75             | 6320075    |                        |
|  | 90             | 6320090    |                        |
|  | 110            | 6320110    |                        |
|  | 125/140        | 6320125    |                        |
|  | 160            | 6320160    |                        |
|  | 200            | 6320200    |                        |
|  | 225            | 6320225    |                        |
|  |                |            | Artikelgroep: 04.02.10 |



\* Artikelnr. 63201: PVC Vlinderklep 230V.

|   | Afmeting in mm | Artikelnr. |
|---|----------------|------------|
| <b>6301</b><br><b>PVC 3-Weg<br/>kogelkraan</b><br>- met elektrische<br>aandrijving 24V of<br>15-30V AC*<br>- L-Boring** | 32             | 6301032    |
|   | 40             | 6301040    |
|   | 50             | 6301050    |
|   | 63             | 6301063    |
|   |                |            |



\* Artikelnr. 63011: PVC 3-Weg kogelkraan 24V - T-Boring.  
\*\* Artikelnr. 63012: PVC 3-Weg kogelkraan 230V - L-Boring.  
\*\* Artikelnr. 63013: PVC 3-Weg kogelkraan 230V - T-Boring.

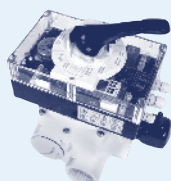
|  | Afmeting      | Artikelnr. |                        |
|--|---------------|------------|------------------------|
| <b>2890</b><br><b>Metalen vlinderklep</b><br>- met elektrische<br>aandrijving 24V*<br>- vlinder: RVS AISI 316<br>- huis: GG25 Rilsan | DN50 (2")     | 2890050    |                        |
|  | DN65 (2 1/2") | 2890065    |                        |
|  | DN80 (3")     | 2890080    |                        |
|  | DN100 (4")    | 2890100    |                        |
|  | DN125 (5")    | 2890125    |                        |
|  | DN150 (6")    | 2890150    |                        |
|  | DN200 (8")    | 2890200    |                        |
|  | DN250 (10")   | 2890250    |                        |
|  |               |            | Artikelgroep: 04.02.10 |



\* Artikelnr. 28901: Metalen vlinderklep 230V.

Bent u op zoek naar een PP elektrisch bediende afsluiter, neem dan contact op met onze afdeling verkoop.

|  | Afmeting | Artikelnr. |
|--|----------|------------|
| <b>1930</b><br><b>Automatische 6-weg spoelklep</b><br>- Superstar E-3000/F2<br>- type 'AO'<br>- 230V | 1 1/2"   | 1930112    |
|  | 2"       | 1930200    |
|  | 3"       | 1930300    |
|  |          |            |



## Elektrisch bediende membraanafsluiters

|   | Afmeting | Voltage | Artikelnr.             |
|---|----------|---------|------------------------|
| <b>8204</b><br><b>Membraanafsluiter Richdel</b><br>- binnendraad<br>- voor o.a. automatische beregeningssystemen<br>- normaal gesloten<br>- minimale voordruk 0,7 bar | 1"       | 24V AC  | 8204100                |
|   | 1 1/2"   | 24V AC  | 8204112                |
|   | 2"       | 24V AC  | 8204200                |
|   |          |         | Artikelgroep: 04.02.15 |



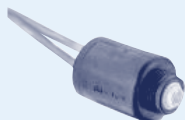
04

|   | Afmeting | Voltage | Artikelnr.             |
|---|----------|---------|------------------------|
| <b>8206</b><br><b>Membraanafsluiter Richdel</b><br>- binnendraad<br>- voor o.a. automatische beregeningssystemen<br>- normaal gesloten<br>- minimale voordruk 0,7 bar | 1"       | 24V DC  | 8206100                |
|   | 1 1/2"   | 24V DC  | 8206112                |
|   | 2"       | 24V DC  | 8206200                |
|   |          |         | Artikelgroep: 04.02.15 |



Artikelnr. 8207: Membraan voor Richdel afsluiter artikelnr. 8204 en 8206.

|   | Voltage | Artikelnr.             |
|---|---------|------------------------|
| <b>8210</b><br><b>Spoel voor Richdel afsluiter (solenoid)</b> | 24V AC  | 8210AC                 |
|   | 24V DC  | 8210DC                 |
|   |         | Artikelgroep: 04.03.05 |




|   | Afmeting | Voltage | Artikelnr.             |
|---|----------|---------|------------------------|
| <b>8236</b><br><b>Membraanafsluiter</b><br>- binnendraad<br>- glasvezel versterkt<br>- met NBR membraan<br>- normaal gesloten*<br>- minimale voordruk 0,5 bar | 1/8"     | 24V AC  | 8236018                |
|   | 1/4"     | 24V AC  | 8236014                |
|   | 3/8"     | 24V AC  | 8236038                |
|   | 1/2"     | 24V AC  | 8236012                |
|   | 3/4"     | 24V AC  | 8236034                |
|   | 1"       | 24V AC  | 8236100                |
|   | 1 1/4"   | 24V AC  | 8236114                |
|   | 1 1/2"   | 24V AC  | 8236112                |
|   | 2"       | 24V AC  | 8236200                |
|   |          |         | Artikelgroep: 04.02.15 |





## 04.02 Elektrisch bediende afsluiters


### Elektrisch bediende membraanafsluiters

04

|   | Afmeting  | Voltage             | Artikelnr. |
|---|---|---------------------|------------|
| <b>8238</b><br><b>Membraanafsluiter</b><br>- binnendraad<br>- glasvezel versterkt<br>- met NBR membraan<br>- normaal gesloten*<br>- minimale voordruk 0,5 bar |  | 1/2" <sup>u</sup>   | 8238012    |
|   |   | 3/4" <sup>u</sup>   | 8238034    |
|   |   | 1" <sup>u</sup>     | 8238100    |
|   |   | 1 1/4" <sup>u</sup> | 8238114    |
|   |   | 1 1/2" <sup>u</sup> | 8238112    |
|   |   | 2" <sup>u</sup>     | 8238200    |
|   |   |                     |            |


|   | Afmeting  | Voltage             | Artikelnr. |
|---|---|---------------------|------------|
| <b>8240</b><br><b>Membraanafsluiter</b><br>- binnendraad<br>- glasvezel versterkt<br>- met NBR membraan<br>- normaal gesloten*<br>- minimale voordruk 0,5 bar |  | 1/2" <sup>u</sup>   | 8240012    |
|   |   | 3/4" <sup>u</sup>   | 8240034    |
|   |   | 1" <sup>u</sup>     | 8240100    |
|   |   | 1 1/4" <sup>u</sup> | 8240114    |
|   |   | 1 1/2" <sup>u</sup> | 8240112    |
|   |   | 2" <sup>u</sup>     | 8240200    |
|   |   |                     |            |

|   | Afmeting  | Artikelnr.               |          |
|---|---|--------------------------|----------|
| <b>82421</b><br><b>Membraan</b><br>- voor industrieafsluiter 8236, 8238 en 8240 |  | 1/2" - 3/4" <sup>u</sup> | 82421012 |
|   |   | 1" - 1 1/4" <sup>u</sup> | 82421100 |
|   |   | 1 1/2" <sup>u</sup>      | 82421112 |
|   |   | 2" <sup>u</sup>          | 82421200 |
|   |   |                          |          |

|  | Voltage   | Artikelnr. |         |
|--|---|------------|---------|
| <b>8242</b><br><b>Spoel voor membraanafsluiter (solenoid)</b><br>- normaal gesloten* |  | 24V AC     | 8242230 |
|  |   | 24V DC     | 8242AC  |
|  |   | 230V       | 8242DC  |
|  |   |            |         |

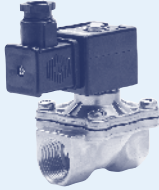
\* Artikelnr. 8243: Spoel voor membraanafsluiter 8236 normaal geopend.

### Elektrisch bediende membraanafsluiters Asco

|  | Afmeting  | Voltage           | Artikelnr. |
|--|---|-------------------|------------|
| <b>8244</b><br><b>Asco messing membraanafsluiter</b><br>- geen voordruk vereist<br>- voorzien van antiwaterslagsysteem<br>- normaal gesloten |  | 3/8" <sup>u</sup> | 8244038    |
|  |   | 1/2" <sup>u</sup> | 8244012    |
|  |   | 3/4" <sup>u</sup> | 8244034    |
|  |   | 1" <sup>u</sup>   | 8244100    |
|  |   |                   |            |

## Elektrisch bediende membraanafsluiters Asco

|  | Afmeting | Voltage | Artikelnr.             |
|--|----------|---------|------------------------|
| <b>8245</b><br><b>Asco messing membraanafsluiter</b><br>- geen voordruk vereist<br>- voorzien van antiwaterslagsysteem<br>- normaal gesloten | 3/8"     | 24V DC  | 8245038                |
|  | 1/2"     | 24V DC  | 8245012                |
|  | 3/4"     | 24V DC  | 8245034                |
|  | 1"       | 24V DC  | 8245100                |
|  |          |         | Artikelgroep: 04.02.20 |



|  | Afmeting | Voltage | Artikelnr.             |
|--|----------|---------|------------------------|
| <b>8246</b><br><b>Asco messing membraanafsluiter</b><br>- geen voordruk vereist<br>- voorzien van antiwaterslagsysteem<br>- normaal gesloten | 3/8"     | 230V    | 8246038                |
|  | 1/2"     | 230V    | 8246012                |
|  | 3/4"     | 230V    | 8246034                |
|  | 1"       | 230V    | 8246100                |
|  |          |         | Artikelgroep: 04.02.20 |



Heeft u interesse in andere producten van het ASCO programma, neem dan contact op met onze afdeling verkoop.

04

## Toebehoren voor afstandbediende afsluiters 04.03

### Accessoires voor afstandbediende afsluiters

|  | Voltage | Artikelnr.             |
|--|---------|------------------------|
| <b>71081</b><br><b>Namur stuurventiel</b><br>- 3/2 en 5/2<br>(universeel)<br>- voor pneumatische aandrijvingen | 24V AC  | 710810                 |
|  | 24V DC  | 710811                 |
|  | 230V    | 710812                 |
|  |         | Artikelgroep: 04.03.05 |



|                                      | Artikelnr.             |
|--------------------------------------|------------------------|
| <b>710820</b><br><b>Smoorventiel</b> | 710820                 |
|                                      | Artikelgroep: 04.03.05 |



|   | Afmeting | Artikelnr.             |
|---|----------|------------------------|
| <b>710830</b><br><b>Demper / korf</b><br>- voor namur | 1/8"     | 710830                 |
|   |          | Artikelgroep: 04.03.05 |



# 04.03 Toebehoren voor afstandbediende afsluiters

## Luchtleidingen en -fittingen

- Voor het bedienen van aandrijvingen.

04

|                        | Afmeting in mm | Rollengte in meter | Artikelnr. |
|------------------------|----------------|--------------------|------------|
| <b>1513</b>            | 6 x 4          | 100                | 1513006100 |
| <b>PE Luchtleiding</b> | 6 x 4          | 500                | 1513006500 |
| - blauw                | 8 x 6          | 100                | 1513008100 |
| - zeer soepel          | 8 x 6          | 500                | 1513008500 |

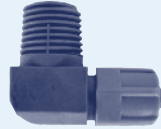
- niet geschikt voor olie, vet en benzine
- niet bestand tegen ultraviolette straling

Artikelgroep: 04.03.10



|                      | Afmeting | Artikelnr. |
|----------------------|----------|------------|
| <b>1515</b>          | 6 x 1/8" | 1515006018 |
| <b>Kniekoppeling</b> | 6 x 1/4" | 1515006014 |
| - met buitendraad    | 8 x 1/8" | 1515008018 |
|                      | 8 x 1/4" | 1515008014 |

Artikelgroep: 04.03.10



|                    | Afmeting in mm | Artikelnr. |
|--------------------|----------------|------------|
| <b>1516</b>        | 6              | 15160006   |
| <b>T-koppeling</b> | 8              | 15160008   |

Artikelgroep: 04.03.10

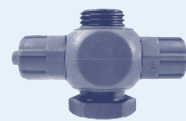


|                         | Afmeting in mm | Artikelnr. |
|-------------------------|----------------|------------|
| <b>1518</b>             | 6 x 6          | 15180006   |
| <b>Rechte koppeling</b> | 8 x 8          | 15180008   |



|                    | Afmeting     | Artikelnr. |
|--------------------|--------------|------------|
| <b>1517</b>        | 6 x 1/8" x 6 | 1517006018 |
| <b>T-koppeling</b> | 6 x 1/4" x 6 | 1517006014 |
|                    | 8 x 1/8" x 8 | 1517008018 |
|                    | 8 x 1/4" x 8 | 1517008014 |

Artikelgroep: 04.03.10



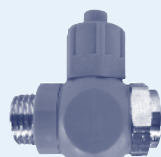
|                           | Afmeting | Artikelnr. |
|---------------------------|----------|------------|
| <b>1514</b>               | 6 x 1/8" | 1514006018 |
| <b>Inschroefkoppeling</b> | 6 x 1/4" | 1514006014 |
| - met buitendraad         | 8 x 1/8" | 1514008018 |
|                           | 8 x 1/4" | 1514008014 |

Artikelgroep: 04.03.10



|                              | Afmeting | Artikelnr. |
|------------------------------|----------|------------|
| <b>1519</b>                  | 6 x 1/8" | 1519006018 |
| <b>Regelventiel</b>          | 6 x 1/4" | 1519006014 |
| - op in- en uitlaat plaatsen | 8 x 1/8" | 1519008018 |
| - smoorklep                  | 8 x 1/4" | 1519008014 |

Artikelgroep: 04.03.10



# Productgroep 05

PE Drukleidingen > PVC Drukleidingen > PP Drukleidingen  
> Afstandbediende afsluiters > C-PVC Programma >  
Blue-system programma > Binnen- en buitenriolering  
> Kabelbescherming en telecom > Milieu programma  
> Tanks > Folie en geotextielen > Halffabrikaten >  
RVS Programma > Malleable programma > Sanitair  
en verwarming > Metalen appendages en fittingen >  
Slangen en koppelingen > Pompen, filters en kabel  
> Lijm, reiniger en toebehoren > Bevestigingsmaterialen >  
Machines en gereedschappen

>> C-PVC Programma

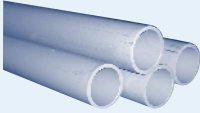
# Milder

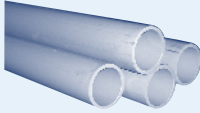
— VEELZIJDIG IN LEIDINGSYSTEMEN —

# 05.01 C-PVC Buis

## C-PVC Buis

- Lengten: standaard op 5 meter.
- Kleur: grijs RAL 7035.

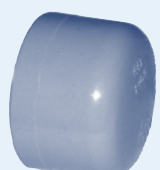
|   | Buitendiameter x wanddikte in mm | Artikelnr. |
|---|----------------------------------|------------|
| <b>3000</b><br><b>C-PVC Buis</b><br>- PN16<br> | 16 x 1,2                         | 3000016    |
|   | 20 x 1,5                         | 3000020    |
|   | 25 x 1,9                         | 3000025    |
|   | 32 x 2,4                         | 3000032    |
|   | 40 x 3,0                         | 3000040    |
|   | 50 x 3,7                         | 3000050    |
|   | 63 x 4,7                         | 3000063    |
|   | 75 x 5,6                         | 3000075    |
|   | 90 x 6,7                         | 3000090    |
|   | 110 x 8,2                        | 3000110    |
|   | 160 x 11,9                       | 3000160    |
| Artikelgroep: 05.01.05  |                                  |            |

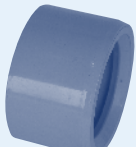
|  | Buitendiameter x wanddikte in mm | Artikelnr. |
|--|----------------------------------|------------|
| <b>3001</b><br><b>C-PVC Buis</b><br>- PN25<br> | 16 x 1,8                         | 3001016    |
|  | 20 x 2,3                         | 3001020    |
|  | 25 x 2,8                         | 3001025    |
|  | 32 x 3,6                         | 3001032    |
|  | Artikelgroep: 05.01.05           |            |


# 05.02 Fittingen voor C-PVC drukleidingen

## C-PVC Fittingen


|  | Afmeting in mm | Artikelnr. |
|--|----------------|------------|
| <b>3010</b><br><b>C-PVC Sok</b><br> | 16             | 3010016    |
|  | 20             | 3010020    |
|  | 25             | 3010025    |
|  | 32             | 3010032    |
|  | 40             | 3010040    |
|  | 50             | 3010050    |
|  | 63             | 3010063    |
|  | 75             | 3010075    |
|  | 90             | 3010090    |
|  | 110            | 3010110    |
|  | 160            | 3010160    |
| Artikelgroep: 05.02.05   |                |            |

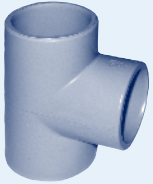
|  | Afmeting in mm         | Artikelnr. |
|--|------------------------|------------|
| <b>3070</b><br><b>C-PVC Eindkap</b><br> | 20                     | 3070020    |
|  | 25                     | 3070025    |
|  | 32                     | 3070032    |
|  | 40                     | 3070040    |
|  | 50                     | 3070050    |
|  | 63                     | 3070063    |
|  | 75                     | 3070075    |
|  | 90                     | 3070090    |
|  | 110                    | 3070110    |
|  | Artikelgroep: 05.02.05 |            |

|  | Afmeting in mm | Artikelnr. |
|--|----------------|------------|
| <b>3090</b><br><b>C-PVC Verloopring</b><br> | 20 x 16        | 3090020016 |
|  | 25 x 20        | 3090025020 |
|  | 32 x 20        | 3090032020 |
|  | 32 x 25        | 3090032025 |
|  | 40 x 32        | 3090040032 |
|  | 50 x 32        | 3090050032 |
|  | 50 x 40        | 3090050040 |
|  | 63 x 32        | 3090063032 |
|  | 63 x 50        | 3090063050 |
|  | 75 x 63        | 3090075063 |
|  | 90 x 75        | 3090090075 |
|  | 110 x 90       | 3090110090 |
|  | 160 x 110      | 3090160110 |
| Artikelgroep: 05.02.05   |                |            |

|   | Afmeting in mm | Artikelnr. |
|---|----------------|------------|
| <b>3050</b><br><b>C-PVC Knie 90°</b><br> | 16             | 3050016    |
|   | 20             | 3050020    |
|   | 25             | 3050025    |
|   | 32             | 3050032    |
|   | 40             | 3050040    |
|   | 50             | 3050050    |
|   | 63             | 3050063    |
|   | 75             | 3050075    |
|   | 90             | 3050090    |
|   | 110            | 3050110    |
|   | 160            | 3050160    |
| Artikelgroep: 05.02.05  |                |            |

## C-PVC Fittingen

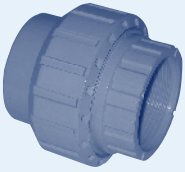
|  | Afmeting in mm | Artikelnr. |
|--|----------------|------------|
| <b>3450</b><br>C-PVC Knie 45°<br> | 20             | 3450020    |
|  | 25             | 3450025    |
|  | 32             | 3450032    |
|  | 40             | 3450040    |
|  | 50             | 3450050    |
|  | 63             | 3450063    |
|  | 75             | 3450075    |
|  | 90             | 3450090    |
|  | 110            | 3450110    |
|  | 160            | 3450160    |
|  |                |            |

|   | Afmeting in mm | Artikelnr.             |
|---|----------------|------------------------|
| <b>3040</b><br>C-PVC T-stuk 90°<br> | 16             | 3040016                |
|   | 20             | 3040020                |
|   | 25             | 3040025                |
|   | 32             | 3040032                |
|   | 40             | 3040040                |
|   | 50             | 3040050                |
|   | 63             | 3040063                |
|   | 75             | 3040075                |
|   | 90             | 3040090                |
|   | 160            | 3040160                |
|   |                | Artikelgroep: 05.02.05 |

|  | Afmeting in mm | Artikelnr. |
|--|----------------|------------|
| <b>3520</b><br>C-PVC Kraagbus<br> | 25             | 3520025    |
|  | 32             | 3520032    |
|  | 40             | 3520040    |
|  | 50             | 3520050    |
|  | 63             | 3520063    |
|  | 75             | 3520075    |
|  | 90             | 3520090    |
|  | 110            | 3520110    |
|  | 160            | 3520160    |
|  |                |            |

Voor flenzen en pakkingen voor C-PVC verwijzen wij u naar groep 1, vanaf blz. 59.

|   | Afmeting in mm | Artikelnr. |
|---|----------------|------------|
| <b>3080</b><br>C-PVC 3-Delige koppeling<br>- 2 x mof<br> | 16             | 3080016    |
|   | 20             | 3080020    |
|   | 25             | 3080025    |
|   | 32             | 3080032    |
|   | 40             | 3080040    |
|   | 50             | 3080050    |
|   | 63             | 3080063    |
|   |                |            |

|  | Afmeting    | Artikelnr.             |
|--|-------------|------------------------|
| <b>3082</b><br>C-PVC 3-Delige koppeling<br>- mof x binnendraad<br> | 20 x 1/2"   | 3082020012             |
|  | 25 x 3/4"   | 3082025034             |
|  | 32 x 1"     | 3082032100             |
|  | 40 x 1 1/4" | 3082040114             |
|  | 50 x 1 1/2" | 3082050112             |
|  | 63 x 2"     | 3082063200             |
|  |             | Artikelgroep: 05.02.05 |

|  | Afmeting    | Artikelnr.             |
|--|-------------|------------------------|
| <b>3712</b><br>C-PVC Schroefbus<br>- mof x binnendraad<br>- met versterkingsring<br> | 16 x 3/8"   | 3712016038             |
|  | 20 x 1/2"   | 3712020012             |
|  | 25 x 3/4"   | 3712025034             |
|  | 32 x 1"     | 3712032100             |
|  | 40 x 1 1/4" | 3712040114             |
|  | 50 x 1 1/2" | 3712050112             |
|  | 63 x 2"     | 3712063200             |
|  |             | Artikelgroep: 05.02.05 |

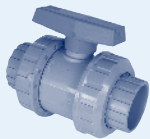
|   | Afmeting         | Artikelnr. |
|---|------------------|------------|
| <b>3212</b><br>C-PVC Puntstuk<br>- spie x mof x buitendraad<br> | 20 x 16 x 3/8"   | 3212020038 |
|   | 25 x 20 x 1/2"   | 3212025012 |
|   | 32 x 25 x 3/4"   | 3212032034 |
|   | 40 x 32 x 1"     | 3212040100 |
|   | 50 x 40 x 1 1/4" | 3212050114 |
|   | 63 x 50 x 1 1/2" | 3212063112 |
|   | 75 x 63 x 2"     | 3212075200 |
|   |                  |            |



## 05.03 Afsluiters voor C-PVC drukleidingen

### C-PVC Afsluiters

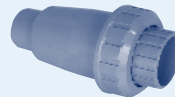
|                         | Afmeting in mm | Artikelnr. |
|-------------------------|----------------|------------|
| <b>4310</b>             | 16             | 4310016    |
| <b>C-PVC Kogelkraan</b> | 20             | 4310020    |
| - 2 x mof               | 25             | 4310025    |
| - EPDM afdichting*      | 32             | 4310032    |
|                         | 40             | 4310040    |
|                         | 50             | 4310050    |
|                         | 63             | 4310063    |
|                         | 75             | 4310075    |
|                         | 90             | 4310090    |



Artikelgroep: 05.03.05

\* Ook leverbaar in FPM (viton).

|                      | Afmeting in mm | Artikelnr. |
|----------------------|----------------|------------|
| <b>3060</b>          | 20             | 3060020    |
| <b>C-PVC</b>         | 25             | 3060025    |
| <b>Terugslagklep</b> | 32             | 3060032    |
| - mof x spie         | 40             | 3060040    |
| - EPDM afdichting*   | 50             | 3060050    |
|                      | 63             | 3060063    |



Artikelgroep: 05.03.05

\* Ook leverbaar in FPM (viton).

## 05.04 Toebehoren voor C-PVC drukleidingen

### Lijm

|                             | Inhoud/ml | Artikelnr.             |
|-----------------------------|-----------|------------------------|
| <b>3713</b>                 | pot 500   | 37130500               |
| <b>C-PVC lijm met kwast</b> |           | Artikelgroep: 19.01.05 |



### Reiniger

|                                   | Inhoud in ml | Artikelnr.             |
|-----------------------------------|--------------|------------------------|
| <b>1725</b>                       | blik 1000    | 17251000               |
| <b>Tangit reiniger</b>            |              | Artikelgroep: 19.01.05 |
| - voor het reinigen van PVC/C-PVC |              |                        |



|   | Inhoud/ml | Artikelnr. |
|---|-----------|------------|
| <b>1713</b>                                   | blik 125  | 171300125  |
| <b>Griffon reiniger</b>                       | blik 500  | 171300500  |
| - voor het reinigen van PVC/C-PVC/Blue-system | blik 1000 | 171301000  |
|   | blik 5000 | 171305000  |



Artikelgroep: 19.01.05

# Productgroep 06

PE Drukleidingen > PVC Drukleidingen > PP Drukleidingen  
> Afstandbediende afsluiters > C-PVC Programma >  
Blue-system programma > Binnen- en buitenriolering  
> Kabelbescherming en telecom > Milieu programma  
> Tanks > Folie en geotextielen > Halffabrikaten >  
RVS Programma > Malleable programma > Sanitair  
en verwarming > Metalen appendages en fittingen >  
Slangen en koppelingen > Pompen, filters en kabel  
> Lijm, reiniger en toebehoren > Bevestigingsmaterialen >  
Machines en gereedschappen

>> Blue-system programma

# Milder

— VEELZIJDIG IN LEIDINGSYSTEMEN —

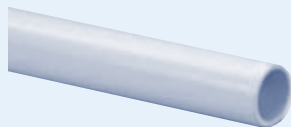
# 06.01 Blue-system buis

## Blue-system buis

- Voor o.a. perslucht.
- Lengten: standaard op 4 meter.

|  | Buitendiameter x wanddikte in mm | Artikelnr. |
|--|----------------------------------|------------|
| <b>6000</b><br>Blue-system buis<br>- kleur: helblauw | 16 x 1,8                         | 6000016    |
|  | 20 x 2,3                         | 6000020    |
|  | 25 x 2,8                         | 6000025    |
|  | 32 x 2,9                         | 6000032    |
|  | 40 x 3,7                         | 6000040    |
|  | 50 x 4,6                         | 6000050    |
|  | 63 x 5,8                         | 6000063    |
|  | 75 x 6,8                         | 6000075    |
|  | 90 x 8,2                         | 6000090    |
|  | 110 x 10,0                       | 6000110    |

Artikelgroep: 06.01.05



06

# 06.02 Fittingen voor Blue-system

## Blue-system fittingen

- Voor o.a. perslucht.

|                    | Afmeting in mm | Artikelnr. |
|--------------------|----------------|------------|
| <b>6010</b><br>Sok | 16             | 6010016    |
|                    | 20             | 6010020    |
|                    | 25             | 6010025    |
|                    | 32             | 6010032    |
|                    | 40             | 6010040    |
|                    | 50             | 6010050    |
|                    | 63             | 6010063    |
|                    | 75             | 6010075    |
|                    | 90             | 6010090    |
|                    | 110            | 6010110    |

Artikelgroep: 06.02.05



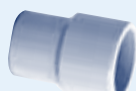
|                        | Afmeting in mm | Artikelnr. |
|------------------------|----------------|------------|
| <b>6070</b><br>Eindkap | 16             | 6070016    |
|                        | 20             | 6070020    |
|                        | 25             | 6070025    |
|                        | 32             | 6070032    |
|                        | 40             | 6070040    |
|                        | 50             | 6070050    |
|                        | 63             | 6070063    |
|                        | 75             | 6070075    |
|                        | 90             | 6070090    |
|                        | 110            | 6070110    |

Artikelgroep: 06.02.05



|                            | Afmeting in mm | Artikelnr.   |
|----------------------------|----------------|--------------|
| <b>6020</b><br>Verloopstuk | 25 x 20 x 16   | 602002520016 |
|                            | 32 x 25 x 20   | 602003225020 |
|                            | 40 x 32 x 25   | 602004032025 |
|                            | 50 x 40 x 32   | 602005040032 |
|                            | 63 x 50 x 25   | 602006350025 |
|                            | 63 x 50 x 32   | 602006350032 |
|                            | 75 x 63 x 32   | 602007563032 |

Artikelgroep: 06.02.05



|                         | Afmeting in mm | Artikelnr. |
|-------------------------|----------------|------------|
| <b>6050</b><br>Knie 90° | 16             | 6050016    |
|                         | 20             | 6050020    |
|                         | 25             | 6050025    |
|                         | 32             | 6050032    |
|                         | 40             | 6050040    |
|                         | 50             | 6050050    |
|                         | 63             | 6050063    |
|                         | 75             | 6050075    |
|                         | 90             | 6050090    |
|                         | 110            | 6050110    |

Artikelgroep: 06.02.05



|                           | Afmeting in mm | Artikelnr. |
|---------------------------|----------------|------------|
| <b>6090</b><br>Verlooring | 20 x 16        | 6090020016 |
|                           | 25 x 20        | 6090025020 |
|                           | 32 x 25        | 6090032025 |
|                           | 40 x 32        | 6090040032 |
|                           | 50 x 40        | 6090050040 |
|                           | 63 x 50        | 6090063050 |
|                           | 75 x 63        | 6090075063 |
|                           | 90 x 75        | 6090090075 |
|                           | 110 x 90       | 6090110090 |

Artikelgroep: 06.02.05




|                         | Afmeting in mm | Artikelnr. |
|-------------------------|----------------|------------|
| <b>6450</b><br>Knie 45° | 16             | 6450016    |
|                         | 20             | 6450020    |
|                         | 25             | 6450025    |
|                         | 32             | 6450032    |
|                         | 40             | 6450040    |
|                         | 50             | 6450050    |
|                         | 63             | 6450063    |
|                         | 75             | 6450075    |
|                         | 90             | 6450090    |
|                         | 110            | 6450110    |

Artikelgroep: 06.02.05




## Blue-system fittingen

|   | Afmeting in mm | Artikelnr.             |
|---|----------------|------------------------|
| <b>6550</b><br>Bocht 90°<br> | 50             | 6550050                |
|   | 63             | 6550063                |
|   | 75             | 6550075                |
|   | 90             | 6550090                |
|   | 110            | 6550110                |
|   |                | Artikelgroep: 06.02.05 |


|  | Afmeting         | Artikelnr.             |
|--|------------------|------------------------|
| <b>6712</b><br>Schroefbus<br>- met versterkingsring<br> | 20 x 16 x 3/8"   | 671202016038           |
|  | 25 x 20 x 1/2"   | 671202520012           |
|  | 32 x 25 x 3/4"   | 671203225034           |
|  | 40 x 32 x 1"     | 671204032100           |
|  | 50 x 40 x 1 1/4" | 671205040114           |
|  | 63 x 50 x 1 1/2" | 671206350112           |
|  | 75 x 63 x 2"     | 671207563200           |
|  | 90 x 75 x 2 1/2" | 671209075212           |
|  |                  | Artikelgroep: 06.02.05 |


|  | Afmeting in mm | Artikelnr.             |
|--|----------------|------------------------|
| <b>6810</b><br>Bocht 180°<br> | 16             | 6810016                |
|  | 20             | 6810020                |
|  | 25             | 6810025                |
|  | 32             | 6810032                |
|  |                | Artikelgroep: 06.02.05 |

|   | Afmeting  | Artikelnr.             |
|---|-----------|------------------------|
| <b>6752</b><br>Knie 90°<br>- met binnendraad<br>- met versterkingsring<br> | 16 x 3/8" | 6752016038             |
|   | 20 x 1/2" | 6752020012             |
|   | 25 x 3/4" | 6752025034             |
|   |           | Artikelgroep: 06.02.05 |

|  | Afmeting in mm | Artikelnr.             |
|--|----------------|------------------------|
| <b>6040</b><br>T-stuk 90°<br> | 16             | 6040016                |
|  | 20             | 6040020                |
|  | 25             | 6040025                |
|  | 32             | 6040032                |
|  | 40             | 6040040                |
|  | 50             | 6040050                |
|  | 63             | 6040063                |
|  | 75             | 6040075                |
|  | 90             | 6040090                |
|  | 110            | 6040110                |
|  |                | Artikelgroep: 06.02.05 |

|   | Afmeting  | Artikelnr.             |
|---|-----------|------------------------|
| <b>6742</b><br>T-stuk 90°<br>- met binnendraad<br>- met versterkingsring<br> | 16 x 1/2" | 6742016012             |
|   | 20 x 1/2" | 6742020012             |
|   | 25 x 3/4" | 6742025034             |
|   |           | Artikelgroep: 06.02.05 |

|  | Afmeting in mm | Artikelnr.             |
|--|----------------|------------------------|
| <b>6140</b><br>Verloop T-stuk 90°<br> | 25 x 16 x 25   | 6140025016             |
|  | 25 x 20 x 25   | 6140025020             |
|  | 32 x 16 x 32   | 6140032016             |
|  | 32 x 20 x 32   | 6140032020             |
|  | 32 x 25 x 32   | 6140032025             |
|  | 40 x 20 x 40   | 6140040020             |
|  | 40 x 25 x 40   | 6140040025             |
|  | 40 x 32 x 40   | 6140040032             |
|  | 50 x 25 x 50   | 6140050025             |
|  | 50 x 32 x 50   | 6140050032             |
|  | 50 x 40 x 50   | 6140050040             |
|  | 63 x 25 x 63   | 6140063025             |
|  | 63 x 32 x 63   | 6140063032             |
|  | 63 x 40 x 63   | 6140063040             |
|  | 75 x 25 x 75   | 6140075025             |
|  | 75 x 32 x 75   | 6140075032             |
|  | 75 x 40 x 75   | 6140075040             |
|  | 90 x 25 x 90   | 6140090025             |
|  | 110 x 32 x 110 | 6140110032             |
|  |                | Artikelgroep: 06.02.05 |


|  | Afmeting in mm         | Artikelnr. |
|--|------------------------|------------|
| <b>6080</b><br>3-Delige koppeling<br> | 16                     | 6080016    |
|  | 20                     | 6080020    |
|  | 25                     | 6080025    |
|  | 32                     | 6080032    |
|  | 40                     | 6080040    |
|  | 50                     | 6080050    |
|  | 63                     | 6080063    |
|  | Artikelgroep: 06.02.05 |            |

|   | Afmeting               | Artikelnr. |
|---|------------------------|------------|
| <b>6291</b><br>3-Delige koppeling<br>- messing<br>- met binnendraad<br>en kunststof<br>inlegstuk<br> | 16 x 3/8"              | 6291016038 |
|   | 20 x 1/2"              | 6291020012 |
|   | 25 x 3/4"              | 6291025034 |
|   | 32 x 1"                | 6291032100 |
|   | 40 x 1 1/4"            | 6291040114 |
|   | 50 x 1 1/2"            | 6291050112 |
|   | 63 x 2"                | 6291063200 |
|   | Artikelgroep: 06.02.05 |            |

## 06.02 Fittingen voor Blue-system

### Blue-system fittingen

|  | Afmeting              | Artikelnr.             |
|--|-----------------------|------------------------|
| <b>6292</b><br><b>3-Delige koppeling</b><br>- messing<br>- met buitendraad | 16 x $\frac{3}{8}$ "  | 6292016038             |
|  | 20 x $\frac{1}{2}$ "  | 6292020012             |
|  | 25 x $\frac{3}{4}$ "  | 6292025034             |
|  | 32 x 1"               | 6292032100             |
|  | 40 x $1\frac{1}{4}$ " | 6292040114             |
|  | 50 x $1\frac{1}{2}$ " | 6292050112             |
|  | 63 x 2"               | 6292063200             |
|  |                       | Artikelgroep: 06.02.05 |




|  | Afmeting in mm | Artikelnr.             |
|--|----------------|------------------------|
| <b>6520</b><br><b>Kraagbus</b><br>- gerild | 50             | 6520050                |
|  | 63             | 6520063                |
|  | 75             | 6520075                |
|  | 90             | 6520090                |
|  | 110            | 6520110                |
|  |                | Artikelgroep: 06.02.05 |



Voor flens zie blz. 59, artikelnr. 5903 en voor pakking zie blz. 80, artikelnr. 5629.


|  | Afmeting                          | Artikelnr. |
|--|-----------------------------------|------------|
| <b>6222</b><br><b>Muurplaat</b><br>- messing | $\frac{1}{2}$ " x $\frac{3}{8}$ " | 6222012038 |
|  | $\frac{3}{4}$ " x $\frac{1}{2}$ " | 6222034012 |
|  | 1" x $\frac{3}{4}$ "              | 6222100034 |
|  |                                   |            |



## 06.03 Afsluiters voor Blue-system

### Blue-system afsluiters


|                                  | Afmeting in mm | Artikelnr. |
|----------------------------------|----------------|------------|
| <b>6148</b><br><b>Kogelkraan</b> | 16             | 6148016    |
|                                  | 20             | 6148020    |
|                                  | 25             | 6148025    |
|                                  | 32             | 6148032    |
|                                  | 40             | 6148040    |
|                                  | 50             | 6148050    |
|                                  | 63             | 6148063    |
|                                  | 75             | 6148075    |
|                                  | 90             | 6148090    |
|                                  | 110            | 6148110    |
|                                  |                |            |




## 06.04 Toebehoren voor Blue-system

### Lijm en reiniger

|  | Inhoud/ml | Artikelnr.             |
|--|-----------|------------------------|
| <b>6149</b><br><b>Blue-system lijm</b> | pot 250   | 61490250               |
|  | pot 1000  | 61491000               |
|  |           | Artikelgroep: 06.02.05 |



|  | Inhoud/ml | Artikelnr.             |
|--|-----------|------------------------|
| <b>1713</b><br><b>Griffon reiniger</b><br>- voor het reinigen van<br>PVC/C-PVC/Blue-system | blik 125  | 171300125              |
|  | blik 500  | 171300500              |
|  | blik 1000 | 171301000              |
|  | blik 5000 | 171305000              |
|  |           | Artikelgroep: 19.01.05 |



# Productgroep 07

PE Drukleidingen > PVC Drukleidingen > PP Drukleidingen  
> Afstandbediende afsluiters > C-PVC Programma >  
Blue-system programma > Binnen- en buitenriolering  
> Kabelbescherming en telecom > Milieu programma  
> Tanks > Folie en geotextielen > Halffabrikaten >  
RVS Programma > Malleable programma > Sanitair  
en verwarming > Metalen appendages en fittingen >  
Slangen en koppelingen > Pompen, filters en kabel  
> Lijm, reiniger en toebehoren > Bevestigingsmaterialen >  
Machines en gereedschappen

>> Binnen- en buitenriolering

# Milder

— VEELZIJDIG IN LEIDINGSYSTEMEN —

# 07.01 Buis voor binnen- en buitenriolering

## PVC Afvoerbuis voor binnen- en buitenriolering

- Met KOMO keur (waar van toepassing).
- Afwijkende lengten op aanvraag leverbaar.
- Voor drukloze toepassing.

SN2 = klasse 51, SN4 = klasse 41, SN8 = klasse 34

|  | Buitendiameter in mm | Klasse | Lengte in meters | Artikelnr. |
|--|----------------------|--------|------------------|------------|
| <b>9300</b><br><b>PVC Afvoerbuis glad</b><br>- kleur: grijs (RAL 7037) | 32                   | SN4    | 4                | 9300032004 |
|  | 40                   | SN4    | 4                | 9300040004 |
|  | 50                   | SN2    | 4                | 9300050002 |
|  | 50                   | SN4    | 4                | 9300050004 |
|  | 75                   | SN2    | 4                | 9300075002 |
|  | 75                   | SN4    | 4                | 9300075004 |
|  | 90                   | SN4    | 4                | 9300090004 |
|  | 110                  | SN2    | 5                | 9300110002 |
|  | 110                  | SN4    | 5                | 9300110004 |
|  | 125                  | SN2    | 5                | 9300125002 |
|  | 125                  | SN4    | 5                | 9300125004 |
|  | 125                  | SN8    | 5                | 9300125008 |
|  | 160                  | SN2    | 5                | 9300160002 |
|  | 160                  | SN4    | 5                | 9300160004 |
|  | 160                  | SN8    | 5                | 9300160008 |
|  | 200                  | SN2    | 5                | 9300200002 |
|  | 200                  | SN4    | 5                | 9300200004 |
|  | 200                  | SN8    | 5                | 9300200008 |

Artikelgroep: 07.01.05

|   | Buitendiameter in mm | Klasse | Lengte in meters | Artikelnr. |
|---|----------------------|--------|------------------|------------|
| <b>9301</b><br><b>PVC Afvoerbuis met manchetmof*</b><br>- kleur: grijs (RAL 7037) | 110                  | SN4    | 5                | 9301110004 |
|   | 125                  | SN2    | 5                | 9301125002 |
|   | 125                  | SN4    | 5                | 9301125004 |
|   | 125                  | SN8    | 5                | 9301125008 |
|   | 160                  | SN2    | 5                | 9301160002 |
|   | 160                  | SN4    | 5                | 9301160004 |
|   | 160                  | SN8    | 5                | 9301160008 |
|   | 200                  | SN2    | 5                | 9301200002 |
|   | 200                  | SN4    | 5                | 9301200004 |
|   | 200                  | SN8    | 5                | 9301200008 |
|   | 250                  | SN2    | 5                | 9301250002 |
|   | 250                  | SN4    | 5                | 9301250004 |
|   | 250                  | SN8    | 5                | 9301250008 |
|   | 315                  | SN2    | 5                | 9301315002 |
|   | 315                  | SN4    | 5                | 9301315004 |
|   | 315                  | SN8    | 5                | 9301315008 |
|   | 400                  | SN2    | 5                | 9301400002 |
|   | 400                  | SN4    | 5                | 9301400004 |
| 400   | SN8                  | 5      | 9301400008       |            |
| 500   | SN2                  | 6      | 9301500002       |            |
| 500   | SN4                  | 6      | 9301500004       |            |
| 500   | SN8                  | 6      | 9301500008       |            |
| 630   | SN4                  | 6      | 9301630004       |            |
| 630   | SN8                  | 6      | 9301630008       |            |

\* Artikelnr. 9302: PVC Afvoerbuis met lijmstof.

Artikelgroep: 07.01.05

|   | Buitendiameter in mm | Klasse | Lengte in meters | Artikelnr. |
|---|----------------------|--------|------------------|------------|
| <b>9800</b><br><b>PVC Afvoerbuis glad</b><br>- kleur: roodbruin | 110                  | SN4    | 5                | 9800110004 |
|   | 125                  | SN4    | 5                | 9800125004 |
|   | 125                  | SN8    | 5                | 9800125008 |
|   | 160                  | SN4    | 5                | 9800160004 |
|   | 160                  | SN8    | 5                | 9800160008 |
|   | 200                  | SN4    | 5                | 9800200004 |
|   | 200                  | SN8    | 5                | 9800200008 |

Artikelgroep: 07.01.10

## PVC Afvoerbuis voor binnen- en buitenriolering

|   | Buitendiameter<br>in mm | Klasse | Lengte in meters | Artikelnr. |
|---|-------------------------|--------|------------------|------------|
| <b>9801</b><br><b>PVC Afvoerbuis met manchetmof</b><br>- kleur: roodbruin | 110                     | SN4    | 5                | 9801110004 |
|   | 125                     | SN4    | 5                | 9801125004 |
|   | 125                     | SN8    | 5                | 9801125008 |
|   | 160                     | SN4    | 5                | 9801160004 |
|   | 160                     | SN8    | 5                | 9801160008 |
|   | 200                     | SN4    | 5                | 9801200004 |
|   | 200                     | SN8    | 5                | 9801200008 |
|   | 250                     | SN4    | 5                | 9801250004 |
|   | 250                     | SN8    | 5                | 9801250008 |
|   | 315                     | SN4    | 5                | 9801315004 |
|   | 315                     | SN8    | 5                | 9801315008 |
|   |                         |        |                  |            |



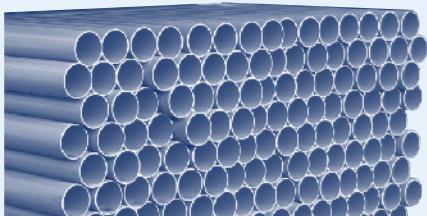
Voor PVC en PE kabelbeschermingsbuis, zie Groep 8 'Kabelbescherming en telecom'.

07

## PVC Regenwaterafvoerbuis

- Met KOMO-keur (waar van toepassing).
- Lengten: 60 t/m 100mm op 4 meter, 80 en 100mm ook op 5,55 meter.

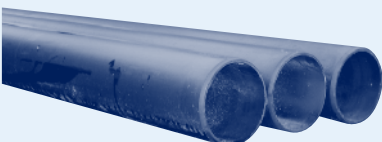
|   | Buitendiameter<br>x wanddikte in mm | Lengte in meters | Artikelnr. |
|---|-------------------------------------|------------------|------------|
| <b>9365</b><br><b>PVC Regenwaterafvoerbuis glad</b><br>- kleur: grijs<br>(RAL 7037) | 60 x 1,5                            | 4                | 9365060    |
|   | 70 x 1,5                            | 4                | 9365070    |
|   | 80 x 1,5                            | 4                | 9365080    |
|   | 80 x 1,5                            | 5,55             | 93650800   |
|   | 100 x 1,8                           | 4                | 9365100    |
|   | 100 x 1,8                           | 5,55             | 93651000   |
|   |                                     |                  |            |



## PP Afvoerbuis

- Met KOMO-keur (waar van toepassing).
- Lengte: 5 meter.
- Voor drukloze toepassingen.

|  | Buitendiameter<br>x wanddikte in mm | Lengte in meters | Artikelnr.             |
|--|-------------------------------------|------------------|------------------------|
| <b>8300</b><br><b>PP Afvoerbuis glad</b><br>- kleur: zwart | 32 x 1,8                            | 4                | 8300032                |
|  | 40 x 1,8                            | 5                | 8300040                |
|  | 50 x 3,0                            | 5                | 8300050                |
|  | 75 x 3,0                            | 5                | 8300075                |
|  | 90 x 3,0                            | 5                | 8300090                |
|  | 110 x 3,4                           | 5                | 8300110                |
|  | 125 x 3,9                           | 5                | 8300125                |
|  | 160 x 4,9                           | 5                | 8300160                |
|  |                                     |                  | Artikelgroep: 07.01.25 |



Diameters 200 t/m 500mm zijn op aanvraag leverbaar.

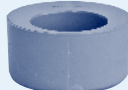


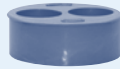
# 07.02 Binnenriolering

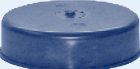
## PVC Afvoer lijmhulpstukken

• Met KOMO-keur (waar van toepassing).

|   | Afmeting in mm         | Artikelnr. |
|---|------------------------|------------|
| <b>9308</b><br>PVC Dubbele mof<br> | 32                     | 9308032    |
|   | 40                     | 9308040    |
|   | 50                     | 9308050    |
|   | 63                     | 9308063    |
|   | 75                     | 9308075    |
|   | 90                     | 9308090    |
|   | 110                    | 9308110    |
|   | 125                    | 9308125    |
|   | 160                    | 9308160    |
|   | 200                    | 9308200    |
|   | Artikelgroep: 07.02.05 |            |

|   | Afmeting in mm | Artikelnr. |
|---|----------------|------------|
| <b>9309</b><br>PVC Verloopring<br> | 40 x 32        | 9309040032 |
|   | 50 x 32        | 9309050032 |
|   | 50 x 40        | 9309050040 |
|   | 75 x 40        | 9309075040 |
|   | 75 x 50        | 9309075050 |
|   | 110 x 40       | 9309110040 |
|   | 110 x 50       | 9309110050 |
|   | 110 x 75       | 9309110075 |
|   | 110 x 90       | 9309110090 |
|   | 125 x 40       | 9309125040 |
|   | 125 x 50       | 9309125050 |
|   | 125 x 75       | 9309125075 |
|   | 125 x 110      | 9309125110 |
|   | 160 x 110      | 9309160110 |
|   | 160 x 125      | 9309160125 |
|   | 200 x 160      | 9309200160 |
| Artikelgroep: 07.02.05  |                |            |


|  | Afmeting in mm         | Artikelnr.  |
|--|------------------------|-------------|
| <b>93091</b><br>PVC Dubbele verloopring<br> | 110 x 40 x 40          | 93091100401 |
|  | 110 x 50 x 50          | 93091100501 |
|  | Artikelgroep: 07.02.05 |             |

|   | Afmeting in mm | Artikelnr. |
|---|----------------|------------|
| <b>9318</b><br>PVC Eindkap<br>- passend over de buis<br> | 32             | 9318032    |
|   | 40             | 9318040    |
|   | 50             | 9318050    |
|   | 60             | 9318060    |
|   | 70             | 9318070    |
|   | 75             | 9318075    |
|   | 80             | 9318080    |
|   | 90             | 9318090    |
|   | 100            | 9318100    |
|   | 110            | 9318110    |
|   | 125            | 9318125    |
|   | 160            | 9318160    |
|   | 200            | 9318200    |
|   | 250            | 9318250    |
|   | 315            | 9318315    |
|   | 400            | 9318400    |
|   | 500            | 9318500    |
| 630   | 9318630        |            |
| Artikelgroep: 07.03.05  |                |            |

|  | Afmeting in mm         | Artikelnr. |
|--|------------------------|------------|
| <b>9311</b><br>PVC Speciedeksel<br> | 25                     | 9311025    |
|  | 32                     | 9311032    |
|  | 40                     | 9311040    |
|  | 50                     | 9311050    |
|  | 63                     | 9311063    |
|  | 75                     | 9311075    |
|  | 80                     | 9311080    |
|  | 90                     | 9311090    |
|  | 100                    | 9311100    |
|  | 110                    | 9311110    |
|  | 125                    | 9311125    |
|  | 160                    | 9311160    |
|  | 200                    | 9311200    |
|  | 250                    | 9311250    |
|  | 315                    | 9311315    |
|  | 400                    | 9311400    |
|  | Artikelgroep: 07.02.05 |            |


|  | Afmeting in mm | Artikelnr. |
|--|----------------|------------|
| <b>9637</b><br>PVC Eindstuk<br>- met schroefdeksel<br>- spie<br> | 32             | 9637032    |
|  | 40             | 9637040    |
|  | 50             | 9637050    |
|  | 75             | 9637075    |
|  | 110            | 9637110    |
|  | 125            | 9637125    |
|  | 160            | 9637160    |
|  | 200            | 9637200    |
|  | 250            | 9637250    |
| 315  | 9637315        |            |
| Artikelgroep: 07.02.05   |                |            |

|  | Afmeting in mm | Artikelnr. |
|--|----------------|------------|
| <b>9303</b><br>PVC Bocht 87°<br>- 2 x mof<br> | 32             | 930303290  |
|  | 40             | 930304090  |
|  | 50             | 930305090  |
|  | 63             | 930306390  |
|  | 75             | 930307590  |
|  | 90             | 930309090  |
|  | 110            | 930311090  |
|  | 125            | 930312590  |
|  | 160            | 930316090  |
| 200  | 930320090      |            |
| Artikelgroep: 07.02.05   |                |            |


|   | Afmeting in mm | Artikelnr. |
|---|----------------|------------|
| <b>9304</b><br>PVC Bocht 87°<br>- mof x spie<br> | 32             | 930403290  |
|   | 40             | 930404090  |
|   | 50             | 930405090  |
|   | 63             | 930406390  |
|   | 75             | 930407590  |
|   | 90             | 930409090  |
|   | 110            | 930411090  |
|   | 125            | 930412590  |
|   | 160            | 930416090  |
| 200   | 930420090      |            |
| Artikelgroep: 07.02.05  |                |            |


07


## PVC Afvoer lijmhulpstukken


|   | Afmeting in mm         | Artikelnr. |
|---|------------------------|------------|
| <b>9303</b><br><b>PVC Bocht 45°</b><br>- 2 x mof<br> | 32                     | 930303245  |
|   | 40                     | 930304045  |
|   | 50                     | 930305045  |
|   | 63                     | 930306345  |
|   | 75                     | 930307545  |
|   | 90                     | 930309045  |
|   | 110                    | 930311045  |
|   | 125                    | 930312545  |
|   | 160                    | 930316045  |
|   | 200                    | 930320045  |
|   | Artikelgroep: 07.02.05 |            |


|   | Afmeting in mm         | Artikelnr. |
|---|------------------------|------------|
| <b>9303</b><br><b>PVC Bocht 15°</b><br>- 2 x mof<br> | 110                    | 930311015  |
|   | 125                    | 930312515  |
|   | Artikelgroep: 07.02.05 |            |


|   | Afmeting in mm         | Artikelnr. |
|---|------------------------|------------|
| <b>9304</b><br><b>PVC Bocht 45°</b><br>- mof x spie<br> | 32                     | 930403245  |
|   | 40                     | 930404045  |
|   | 50                     | 930405045  |
|   | 63                     | 930406345  |
|   | 75                     | 930407545  |
|   | 90                     | 930409045  |
|   | 110                    | 930411045  |
|   | 125                    | 930412545  |
|   | 160                    | 930416045  |
|   | 200                    | 930420045  |
|   | Artikelgroep: 07.02.05 |            |

|   | Afmeting in mm | Artikelnr. |
|---|----------------|------------|
| <b>9305</b><br><b>PVC T-stuk 87°</b><br>- 3 x mof<br> | 32 x 32        | 9305032033 |
|   | 40 x 40        | 9305040041 |
|   | 50 x 40        | 9305050041 |
|   | 50 x 50        | 9305050051 |
|   | 75 x 40        | 9305075041 |
|   | 75 x 50        | 9305075051 |
|   | 75 x 75        | 9305075076 |
|   | 90 x 90        | 9305090091 |
|   | 110 x 40       | 9305110041 |
|   | 110 x 50       | 9305110051 |
|   | 110 x 75       | 9305110076 |
|   | 110 x 110      | 9305110111 |
|   | 125 x 40       | 9305125041 |
|   | 125 x 50       | 9305125051 |
|   | 125 x 75       | 9305125076 |
|   | 125 x 110      | 9305125111 |
|   | 125 x 125      | 9305125126 |
|   | 160 x 110      | 9305160111 |
|   | 160 x 125      | 9305160126 |
|   | 160 x 160      | 9305160161 |
| 200 x 200   | 9305200201     |            |
| Artikelgroep: 07.02.05  |                |            |

|   | Afmeting in mm         | Artikelnr. |
|---|------------------------|------------|
| <b>9303</b><br><b>PVC Bocht 30°</b><br>- 2 x mof<br> | 110                    | 930311030  |
|   | 125                    | 930312530  |
|   | Artikelgroep: 07.02.05 |            |

|   | Afmeting in mm | Artikelnr. |
|---|----------------|------------|
| <b>9303</b><br><b>PVC Bocht 22°</b><br>- 2 x mof<br> | 32             | 930303220  |
|   | 40             | 930304020  |
|   | 50             | 930305020  |
|   | 75             | 930307520  |
|   | 90             | 930309020  |
|   | 110            | 930311020  |
|   | 125            | 930312520  |
| Artikelgroep: 07.02.05  |                |            |

|  | Afmeting in mm | Artikelnr. |
|--|----------------|------------|
| <b>9306</b><br><b>PVC T-stuk 87°</b><br>- 2 x mof, 1 x spie<br> | 32 x 32        | 9306032033 |
|  | 40 x 40        | 9306040041 |
|  | 50 x 40        | 9306050041 |
|  | 50 x 50        | 9306050051 |
|  | 75 x 40        | 9306075041 |
|  | 75 x 50        | 9306075051 |
|  | 75 x 75        | 9306075076 |
|  | 110 x 40       | 9306110041 |
|  | 110 x 50       | 9306110051 |
|  | 110 x 75       | 9306110076 |
|  | 110 x 110      | 9306110111 |
|  | 125 x 40       | 9306125041 |
|  | 125 x 50       | 9306125051 |
|  | 125 x 75       | 9306125076 |
|  | 125 x 110      | 9306125111 |
|  | 125 x 125      | 9306125126 |
|  | 160 x 110      | 9306160111 |
| 160 x 125  | 9306160126     |            |
| 160 x 160  | 9306160161     |            |
| Artikelgroep: 07.02.05   |                |            |

|  | Afmeting in mm | Artikelnr. |
|--|----------------|------------|
| <b>9304</b><br><b>PVC Bocht 22°</b><br>- mof x spie<br> | 32             | 930403220  |
|  | 40             | 930404020  |
|  | 50             | 930405020  |
|  | 75             | 930407520  |
|  | 90             | 930409020  |
|  | 110            | 930411020  |
|  | 125            | 930412520  |
| Artikelgroep: 07.02.05   |                |            |

# 07.02 Binnenriolering

## PVC Afvoer lijmhulpstukken

07

|   | Afmeting in mm | Artikelnr. |
|---|----------------|------------|
| <b>9305</b><br><b>PVC T-stuk 45°</b><br>- 3 x mof | 32 x 32        | 9305032032 |
|   | 40 x 40        | 9305040040 |
|   | 50 x 40        | 9305050040 |
|   | 50 x 50        | 9305050050 |
|   | 63 x 63        | 9305063063 |
|   | 75 x 40        | 9305075040 |
|   | 75 x 50        | 9305075050 |
|   | 75 x 75        | 9305075075 |
|   | 90 x 90        | 9305090090 |
|   | 110 x 40       | 9305110040 |
|   | 110 x 50       | 9305110050 |
|   | 110 x 75       | 9305110075 |
|   | 110 x 110      | 9305110110 |
|   | 125 x 40       | 9305125040 |
|   | 125 x 50       | 9305125050 |
|   | 125 x 75       | 9305125075 |
|   | 125 x 110      | 9305125110 |
|   | 125 x 125      | 9305125125 |
|   | 160 x 110      | 9305160110 |
|   | 160 x 125      | 9305160125 |
| 160 x 160   | 9305160160     |            |
| 200 x 200   | 9305200200     |            |

Artikelgroep: 07.02.05



|  | Afmeting in mm | Artikelnr.             |
|--|----------------|------------------------|
| <b>9307</b><br><b>PVC Dubbel T-stuk 87°</b><br>- 3 x mof, 1 x spie | 50             | 930705090              |
|  | 75             | 930707590              |
|  | 110            | 930711090              |
|  | 125            | 930712590              |
|  | 160            | 930716090              |
|  |                | Artikelgroep: 07.02.05 |



|   | Afmeting in mm | Artikelnr.             |
|---|----------------|------------------------|
| <b>9316</b><br><b>PVC Ontstoppings T-stuk</b><br>- 2 x mof<br>- met schroefdeksel | 110            | 9316110                |
|   | 125            | 9316125                |
|   | 160            | 9316160                |
|   |                | Artikelgroep: 07.02.05 |



|   | Afmeting in mm | Artikelnr. |
|---|----------------|------------|
| <b>9306</b><br><b>PVC T-stuk 45°</b><br>- 2 x mof, 1 x spie | 32 x 32        | 9306032032 |
|   | 40 x 40        | 9306040040 |
|   | 50 x 40        | 9306050040 |
|   | 50 x 50        | 9306050050 |
|   | 63 x 63        | 9306063063 |
|   | 75 x 40        | 9306075040 |
|   | 75 x 50        | 9306075050 |
|   | 75 x 75        | 9306075075 |
|   | 110 x 40       | 9306110040 |
|   | 110 x 50       | 9306110050 |
|   | 110 x 75       | 9306110075 |
|   | 110 x 110      | 9306110110 |
|   | 125 x 40       | 9306125040 |
|   | 125 x 50       | 9306125050 |
|   | 125 x 75       | 9306125075 |
|   | 125 x 110      | 9306125110 |
|   | 125 x 125      | 9306125125 |
|   | 160 x 110      | 9306160110 |
| 160 x 125   | 9306160125     |            |
| 160 x 160   | 9306160160     |            |

Artikelgroep: 07.02.05



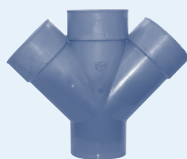
|  | Afmeting in mm | Artikelnr.             |
|--|----------------|------------------------|
| <b>9315</b><br><b>PVC Expansiestuk</b> | 40             | 9315040                |
|  | 50             | 9315050                |
|  | 75             | 9315075                |
|  | 110            | 9315110                |
|  | 125            | 9315125                |
|  | 160            | 9315160                |
|  |                | Artikelgroep: 07.02.05 |



|   | Afmeting in mm | Artikelnr.             |
|---|----------------|------------------------|
| <b>9319</b><br><b>PVC Krimpmof</b><br>- overgang PVC op ander materiaal | 50 x 69        | 9319050069             |
|   | 75 x 88        | 9319075088             |
|   | 110 x 121      | 9319110121             |
|   | 125 x 148      | 9319125148             |
|   | 160 x 174      | 9319160174             |
|   |                | Artikelgroep: 07.02.05 |



|  | Afmeting in mm | Artikelnr.             |
|--|----------------|------------------------|
| <b>9307</b><br><b>PVC Dubbel T-stuk 45°</b><br>- 3 x mof, 1 x spie | 50             | 930705045              |
|  | 75             | 930707545              |
|  | 110            | 930711045              |
|  | 125            | 930712545              |
|  | 160            | 930716045              |
|  |                | Artikelgroep: 07.02.05 |



|   | Afmeting in mm | Artikelnr.             |
|---|----------------|------------------------|
| <b>9320</b><br><b>Dubbele rubberring</b><br>- voor krimpmof | 110            | 9320110                |
|   | 125            | 9320125                |
|   |                | Artikelgroep: 07.02.05 |




|   | Afmeting in mm | Artikelnr.             |
|---|----------------|------------------------|
| <b>9321</b><br><b>PVC Riool-klemzadel</b> | 80/75 x 40     | 932108075040           |
|   | 80/75 x 50     | 932108075050           |
|   | 100/110 x 40   | 9321100110040          |
|   | 100/110 x 50   | 9321100110050          |
|   |                | Artikelgroep: 07.02.05 |



## PVC Afvoer lijm- en/of manchethulpstukken

|                         | Afmeting in mm | Artikelnr. |
|-------------------------|----------------|------------|
| <b>9324</b>             | 110 x 40       | 9324110040 |
| <b>PVC</b>              | 110 x 50       | 9324110050 |
| <b>Klemaanboorzadel</b> | 125 x 40       | 9324125040 |
| - met manchet           | 125 x 50       | 9324125050 |

Artikelgroep: 07.03.05



|                           | Afmeting in mm | Artikelnr.             |
|---------------------------|----------------|------------------------|
| <b>9436</b>               | 40             | 9436040                |
| <b>PP Bocht draaibaar</b> | 110 *          | 94361101               |
| - draaibaar van 0° - 90°  |                | Artikelgroep: 07.03.05 |
| - 2 x manchet             |                |                        |




\* manchet x spie

|                            | Afmeting in mm | Artikelnr.             |
|----------------------------|----------------|------------------------|
| <b>9440</b>                | 110            | 9440110                |
| <b>PP T-stuk draaibaar</b> |                | Artikelgroep: 07.03.05 |
| - draaibaar van 0°-90°     |                |                        |
| - 2 x manchet, 1 x spie    |                |                        |



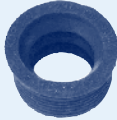
|                          | Afmeting in mm | Artikelnr. |
|--------------------------|----------------|------------|
| <b>5048</b>              | 32             | 5048032    |
| <b>PVC Terugslagklep</b> | 40             | 5048040    |
| - met volle doorlaat     | 50             | 5048050    |
|                          | 63             | 5048063    |

Artikelgroep: 02.06.20



|                                | Afmeting in mm | Artikelnr. |
|--------------------------------|----------------|------------|
| <b>9322</b>                    | 40 x 32        | 9322040032 |
| <b>Rubber overgangsmanchet</b> | 50 x 32        | 9322050032 |
| - PVC x metaal                 | 50 x 40        | 9322050040 |

Artikelgroep: 07.02.05




|                            | Afmeting    | Artikelnr.             |
|----------------------------|-------------|------------------------|
| <b>9312</b>                | 32 x 1 1/4" | 9312032114             |
| <b>PP Universele sifon</b> | 40 x 1 1/2" | 9312040112             |
| - kleur: wit               |             | Artikelgroep: 07.02.05 |




|                                 | Afmeting in mm | Artikelnr. |
|---------------------------------|----------------|------------|
| <b>9317</b>                     | 32             | 9317032    |
| <b>PVC Universele S/P sifon</b> | 40             | 9317040    |
|                                 | 50             | 9317050    |

Artikelgroep: 07.02.05



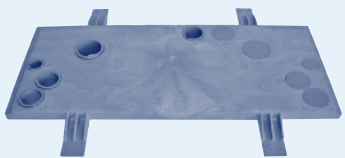
|                      | Afmeting in mm | Artikelnr. |
|----------------------|----------------|------------|
| <b>9326</b>          | 32/40          | 9326032040 |
| <b>PVC Beluchter</b> | 50/63          | 9326050063 |

Artikelgroep: 07.02.05



## PVC Doorvoerbochten

|                            | Afmeting in mm | Artikelnr.             |
|----------------------------|----------------|------------------------|
| <b>9529</b>                | 786 x 328 x 30 | 9529                   |
| <b>Meterkastvloerplaat</b> |                | Artikelgroep: 07.02.10 |



# 07.02 Binnenriolering

## PVC Doorvoerbochten

07

|   | Afmeting in mm | L1/L2 in mm | R in mm         | Artikelnr.      |
|---|----------------|-------------|-----------------|-----------------|
| <b>3203</b><br>PVC Doorvoerbocht 90°<br> | 32             | 1200/1200   | 500             | 320303212000500 |
|   | 32             | 4250/4250   | 500             | 320303242500500 |
|   | 40             | 700/1100    | 400             | 320304011000400 |
|   | 40             | 1100/1200   | 750             | 320304012000750 |
|   | 50             | 700/1100    | 400             | 320305011000400 |
|   | 50             | 1200/1200   | 500             | 320305012000500 |
|   | 50             | 1000/1700   | 600             | 320305017000600 |
|   | 50             | 1100/1200   | 750             | 320305012000750 |
|   | 50             | 1200/1600   | 900             | 320305016000900 |
|   | 75             | 800/1100    | 600             | 320307511000600 |
|   | 75             | 1100/1200   | 750             | 320307512000750 |
|   | 75             | 1100/1300   | 900             | 320307513000900 |
|   | 110            | 1300/1350   | 1100            | 320311013501100 |
|   | 110            | 1100/1700   | 750             | 320311017000750 |
|   | 125            | 1350/1350   | 750             | 320312513500750 |
|   | 160            | 1350/1350   | 1100            | 320316013501100 |
|   | 200            | 1350/1350   | 1100            | 320320013501100 |
|   | 250            | 2000/2000   | 1500            | 320325020001500 |
| 315   | 2500/2500      | 2000        | 320331525002000 |                 |

Artikelgroep: 07.02.10

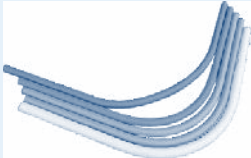
|  | Afmeting in mm | L1/L2 in mm | R in mm | Artikelnr.      |
|--|----------------|-------------|---------|-----------------|
| <b>3202</b><br>PVC Gasdoorvoerbocht 90°<br>- kleur: geel<br>- slagvast<br> | 50             | 600/1100    | 400     | 320205006001100 |
|  | 50             | 1100/4070   | 400     | 320205011004070 |
|  | 63             | 750/1120    | 500     | 320206307501120 |
|  | 63             | 750/2800    | 500     | 320206307502800 |
|  | 63             | 750/4460    | 500     | 320206307504460 |

Artikelgroep: 07.02.10

|  |         | Afmeting in mm | L1/L2     | R in mm | Kleur      | Artikelnr. |
|--|---------|----------------|-----------|---------|------------|------------|
| <b>3204</b><br>PVC Doorvoerbocht<br>- kort model | CAI     | 50             | 1250/1200 | 500     | Lichtgroen | 3204050C   |
|  | Elektra | 50             | 1250/1200 | 500     | Rood       | 3204050E   |
|  | Telecom | 50             | 1250/1200 | 500     | Grijs      | 3204050T   |
|  | Water   | 50             | 1750/1200 | 750     | Blauw      | 3204050W   |
|  | Gas     | 63             | 1250/1200 | 500     | Geel       | 3204063G   |

|                              |              |  |  |  |  |       |
|------------------------------|--------------|--|--|--|--|-------|
| <b>32041</b><br>Complete set | Complete set |  |  |  |  | 32041 |
|------------------------------|--------------|--|--|--|--|-------|

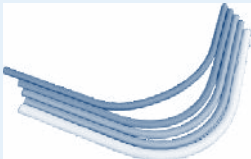
Artikelgroep: 07.02.10



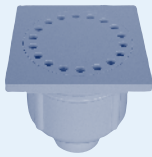
|  |         | Afmeting in mm | L1/L2     | R in mm | Kleur      | Artikelnr. |
|--|---------|----------------|-----------|---------|------------|------------|
| <b>3205</b><br>PVC Doorvoerbocht<br>- lang model | CAI     | 50             | 1200/4250 | 500     | Lichtgroen | 3205050C   |
|  | Elektra | 50             | 1200/4250 | 500     | Rood       | 3205050E   |
|  | Telecom | 50             | 1200/4250 | 500     | Grijs      | 3205050T   |
|  | Water   | 50             | 1200/4250 | 750     | Blauw      | 3205050W   |
|  | Gas     | 63             | 1200/4250 | 500     | Geel       | 3205063G   |


|                              |              |  |  |  |  |       |
|------------------------------|--------------|--|--|--|--|-------|
| <b>32051</b><br>Complete set | Complete set |  |  |  |  | 32051 |
|------------------------------|--------------|--|--|--|--|-------|

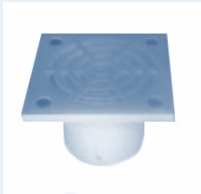
Artikelgroep: 07.02.10

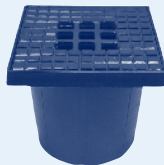


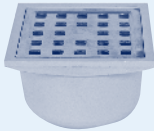
## Vloerputten en toebehoren


|   | Afmeting in mm         | Uitlaat      | Artikelnr. |
|---|------------------------|--------------|------------|
| <b>9313</b><br>PVC<br>Douchesifon<br>- uitlaat 40mm                               | 100 x 100              | onderuitlaat | 9313040    |
|   | 100 x 100              | zijuitlaat   | 9313041    |
|   | Artikelgroep: 07.02.15 |              |            |
|  |                        |              |            |


|  | Afmeting in mm         | Artikelnr. |
|--|------------------------|------------|
| <b>9327</b><br>PE Vloerput<br>- met onderuitlaat 75mm<br>- geheel kunststof<br>- inclusief emmer | 200 x 200              | 9327200200 |
|  | Artikelgroep: 07.02.15 |            |
|               |                        |            |


|   | Afmeting in mm         | Artikelnr. |
|---|------------------------|------------|
| <b>9314</b><br>PVC<br>Vloer-/bodemput<br>- wit                                    | 120 x 120              | 9314       |
|   | Artikelgroep: 07.02.15 |            |
|  |                        |            |


|   | Afmeting in mm         | Artikelnr. |
|---|------------------------|------------|
| <b>9329</b><br>PE Vloerput<br>- met onderuitlaat 75mm<br>- met gietijzer rooster<br>- inclusief emmer | 200 x 200              | 9329200200 |
|   | Artikelgroep: 07.02.15 |            |
|                    |                        |            |

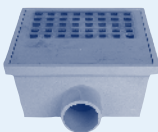
|   | Afmeting in mm         | Artikelnr. |
|---|------------------------|------------|
| <b>93250</b><br>RVS Doucheplug<br>- met onderuitlaat 40mm                           | 100 x 100              | 93250      |
|   | Artikelgroep: 07.02.15 |            |
|  |                        |            |

|   | Afmeting in mm         | Artikelnr. |
|---|------------------------|------------|
| <b>9332</b><br>PVC Vloerput<br>- met zijuitlaat 75mm<br>- met RVS rooster             | 200 x 200              | 9332200200 |
|   | Artikelgroep: 07.02.15 |            |
|  |                        |            |

|   | Afmeting in mm         | Artikelnr. |
|---|------------------------|------------|
| <b>93251</b><br>RVS Reparatieplug<br>- voorzien van rand en rooster                 | 100 x 100              | 93251      |
|   | Artikelgroep: 07.02.15 |            |
|  |                        |            |

|   | Afmeting in mm         | Artikelnr. |
|---|------------------------|------------|
| <b>9333</b><br>PVC Vloerput<br>- met onderuitlaat 75mm<br>- met RVS rooster           | 200 x 200              | 9333200200 |
|   | Artikelgroep: 07.02.15 |            |
|  |                        |            |

|   | Afmeting in mm | Afmeting uitlaat in mm | Artikelnr. |
|---|----------------|------------------------|------------|
| <b>9328</b><br>PVC Vloerput<br>- zware uitvoering<br>- laag model                   | 150 x 150      | onderuitlaat 40/50     | 9328150150 |
|   | 200 x 200      | onderuitlaat 63/75     | 9328200200 |
|   | 250 x 250      | onderuitlaat 90/110    | 9328250250 |
|   | 250 x 250      | zijuitlaat 90/110      | 9328250251 |
|   | 300 x 300      | onderuitlaat 90/110    | 9328300300 |
|   | 300 x 300      | zijuitlaat 90/110      | 9328300301 |
| Artikelgroep: 07.02.15  |                |                        |            |
|  |                |                        |            |

|   | Afmeting in mm         | Artikelnr. |
|---|------------------------|------------|
| <b>9331</b><br>PVC Vloerput<br>- met zijuitlaat 40mm<br>- met RVS rooster           | 150 x 150              | 9331150150 |
|   | Artikelgroep: 07.02.15 |            |
|  |                        |            |

|   | Afmeting in mm         | Uitlaat      | Artikelnr. |
|---|------------------------|--------------|------------|
| <b>9334</b><br>Aluminium vloerput<br>- uitlaat 75mm                                   | 200 x 200              | onderuitlaat | 9334200200 |
|   | Artikelgroep: 07.02.15 |              |            |
|  |                        |              |            |

# 07.02 Binnenriolering

## PP Afvoer manchethulpstukken

07

|                            | Afmeting in mm         | Artikelnr. |
|----------------------------|------------------------|------------|
| <b>8337</b><br>PP Steekmof | 32                     | 8337032    |
|                            | 40                     | 8337040    |
|                            | 50                     | 8337050    |
|                            | 75                     | 8337075    |
|                            | 90                     | 8337090    |
|                            | 110                    | 8337110    |
|                            | 125                    | 8337125    |
|                            | 160                    | 8337160    |
|                            | 200                    | 8337200    |
|                            | Artikelgroep: 07.02.20 |            |



|   | Afmeting in mm         | Artikelnr. |  |
|---|------------------------|------------|--|
| <b>8335</b><br>PP Bocht 88.5°<br>- mof x spie | 32                     | 833503290  |  |
|   | 40                     | 833504090  |  |
|   | 50                     | 833505090  |  |
|   | 75                     | 833507590  |  |
|   | 90                     | 833509090  |  |
|   | 110                    | 833511090  |  |
|   | 125                    | 833512590  |  |
|   | 160                    | 833516090  |  |
|   | Artikelgroep: 07.02.20 |            |  |



|                                 | Afmeting in mm | Artikelnr. |
|---------------------------------|----------------|------------|
| <b>8338</b><br>PP Overschuifmof | 32             | 8338032    |
|                                 | 40             | 8338040    |
|                                 | 50             | 8338050    |
|                                 | 75             | 8338075    |
|                                 | 90             | 8338090    |
|                                 | 110            | 8338110    |
|                                 | 125            | 8338125    |
|                                 | 160            | 8338160    |
| Artikelgroep: 07.02.20          |                |            |



|  | Afmeting in mm | Artikelnr. |
|--|----------------|------------|
| <b>8336</b><br>PP Bocht 45°<br>- 2 x mof | 32             | 833603245  |
|  | 40             | 833604045  |
|  | 50             | 833605045  |
|  | 75             | 833607545  |
|  | 90             | 833609045  |
|  | 110            | 833611045  |
|  | 125            | 833612545  |
|  | 160            | 833616045  |
| Artikelgroep: 07.02.20                   |                |            |



|  | Afmeting in mm | Artikelnr. |
|--|----------------|------------|
| <b>8345</b><br>PP Inzetverlooping<br>- excentrisch<br>- mof x spie | 40 x 32        | 8345040032 |
|  | 50 x 32        | 8345050032 |
|  | 50 x 40        | 8345050040 |
|  | 75 x 40        | 8345075040 |
|  | 75 x 50        | 8345075050 |
|  | 90 x 50        | 8345090050 |
|  | 90 x 75        | 8345090075 |
|  | 110 x 40       | 8345110040 |
|  | 110 x 50       | 8345110050 |
|  | 110 x 75       | 8345110075 |
|  | 110 x 90       | 8345110090 |
|  | 125 x 110      | 8345125110 |
|  | 160 x 110      | 8345160110 |
|  | 160 x 125      | 8345160125 |
| Artikelgroep: 07.02.20   |                |            |



|   | Afmeting in mm | Artikelnr. |
|---|----------------|------------|
| <b>8335</b><br>PP Bocht 45°<br>- mof x spie | 32             | 833503245  |
|   | 40             | 833504045  |
|   | 50             | 833505045  |
|   | 75             | 833507545  |
|   | 90             | 833509045  |
|   | 110            | 833511045  |
|   | 125            | 833512545  |
|   | 160            | 833516045  |
| Artikelgroep: 07.02.20                      |                |            |



|  | Afmeting in mm | Artikelnr. |
|--|----------------|------------|
| <b>8336</b><br>PP Bocht 88.5°<br>- 2 x mof | 32             | 833603290  |
|  | 40             | 833604090  |
|  | 50             | 833605090  |
|  | 75             | 833607590  |
|  | 90             | 833609090  |
|  | 110            | 833611090  |
|  | 125            | 833612590  |
| Artikelgroep: 07.02.20                     |                |            |



|  | Afmeting in mm         | Artikelnr. |
|--|------------------------|------------|
| <b>8336</b><br>PP Bocht 30°<br>- 2 x mof | 75                     | 833607530  |
|  | 90                     | 833609030  |
|  | 110                    | 833611030  |
|  | 125                    | 833612530  |
|  | 160                    | 833616030  |
|  | Artikelgroep: 07.02.20 |            |




## PP Afvoer manchethulpstukken

|   | Afmeting in mm | Artikelnr.             |
|---|----------------|------------------------|
| <b>8335</b><br>PP Bocht 30°<br>- mof x spie | 50             | 833505030              |
|   | 75             | 833507530              |
|   | 90             | 833509030              |
|   | 110            | 833511030              |
|   | 125            | 833512530              |
|   | 160            | 833516030              |
|   |                | Artikelgroep: 07.02.20 |



|   | Afmeting in mm | Artikelnr.             |
|---|----------------|------------------------|
| <b>8339</b><br>PP T-stuk 88,5°<br>- 2 x mof, 1 x spie | 40 x 40        | 833904090              |
|   | 50 x 50        | 833905090              |
|   | 75 x 50        | 833907505090           |
|   | 75 x 75*       | 833907590              |
|   | 90 x 90        | 833909090              |
|   | 110 x 50       | 833911005090           |
|   | 110 x 75       | 833911007590           |
|   | 110 x 110*     | 833911090              |
|   | 125 x 110      | 833912511090           |
|   | 125 x 125      | 833912590              |
|   |                | Artikelgroep: 07.02.20 |




\* Stroomuitvoering

|  | Afmeting in mm | Artikelnr.             |
|--|----------------|------------------------|
| <b>8336</b><br>PP Bocht 15°<br>- 2 x mof | 75             | 833607515              |
|  | 110            | 833611015              |
|  | 125            | 833612515              |
|  | 160            | 833616015              |
|  |                | Artikelgroep: 07.02.20 |



|   | Afmeting in mm | Artikelnr.             |
|---|----------------|------------------------|
| <b>8340</b><br>PP T-stuk 45°<br>- 3 x mof | 32 x 32        | 834003245              |
|   | 40 x 40        | 834004045              |
|   | 50 x 50        | 834005045              |
|   | 75 x 50        | 834007505045           |
|   | 75 x 75        | 834007545              |
|   | 90 x 90        | 834009045              |
|   | 110 x 50       | 834011005045           |
|   | 110 x 75       | 834011007545           |
|   | 110 x 110      | 834011045              |
|   | 125 x 110      | 834012511045           |
|   | 125 x 125      | 834012545              |
|   |                | Artikelgroep: 07.02.20 |




|   | Afmeting in mm | Artikelnr.             |
|---|----------------|------------------------|
| <b>8335</b><br>PP Bocht 15°<br>- mof x spie | 50             | 833505015              |
|   | 75             | 833507515              |
|   | 110            | 833511015              |
|   | 125            | 833512515              |
|   | 160            | 833516015              |
|   |                | Artikelgroep: 07.02.20 |



|   | Afmeting in mm | Artikelnr.             |
|---|----------------|------------------------|
| <b>8339</b><br>PP T-stuk 45°<br>- 2 x mof, 1 x spie | 40 x 40        | 833904045              |
|   | 50 x 50        | 833905045              |
|   | 75 x 50        | 833907505045           |
|   | 75 x 75        | 833907545              |
|   | 90 x 90        | 833909045              |
|   | 110 x 50       | 833911005045           |
|   | 110 x 75       | 833911007545           |
|   | 110 x 110      | 833911045              |
|   | 125 x 110      | 833912511045           |
|   | 125 x 125      | 833912545              |
|   | 160 x 110      | 833916011045           |
|   | 160 x 125      | 833916012545           |
|   | 160 x 160      | 833916045              |
|   |                | Artikelgroep: 07.02.20 |



|   | Afmeting in mm | Artikelnr.   |
|---|----------------|--------------|
| <b>8340</b><br>PP T-stuk 88,5°<br>- 3 x mof | 32 x 32        | 834003290    |
|   | 40 x 40        | 834004090    |
|   | 50 x 50        | 834005090    |
|   | 75 x 50        | 834007505090 |
|   | 75 x 75*       | 834007590    |
|   | 90 x 90        | 834009090    |
|   | 110 x 50       | 834011005090 |
|   | 110 x 75*      | 834011007590 |
|   | 110 x 110*     | 834011090    |
|   | 125 x 110      | 834012511090 |
|   | 125 x 125      | 834012590    |
|   | 160 x 160      | 834016090    |
|   |                |              |



\* Stroomuitvoering



# 07.03 Buitenriolering

## PVC Afvoer manchethulpstukken SN4 (waar van toepassing)

• Met KOMO-keur (waar van toepassing).

|   | Afmeting in mm | Artikelnr.             |
|---|----------------|------------------------|
| <b>9337</b><br><b>PVC Steekmof</b><br>- met stootrand | 110            | 9337110                |
|   | 125            | 9337125                |
|   | 160            | 9337160                |
|   | 200            | 9337200                |
|   | 250            | 9337250                |
|   | 315            | 9337315                |
|   | 400            | 9337400                |
|   | 500            | 9337500                |
|   | 630            | 9337630                |
|   |                | Artikelgroep: 07.03.05 |



|  | Afmeting in mm         | Artikelnr.    |
|--|------------------------|---------------|
| <b>9355</b><br><b>PVC Verloopstuk</b><br>- excentrisch<br>- spie x manchet | 125 x 110              | 9355125110    |
|  | 160 x 110              | 9355160110    |
|  | 160 x 125              | 9355160125    |
|  | 200 x 125 *            | 9355200125008 |
|  | 200 x 160 *            | 9355200160008 |
|  | 250 x 200              | 9355250200    |
|  | 315 x 200              | 9355315200    |
|  | 315 x 250              | 9355315250    |
|  | 400 x 315              | 9355400315    |
|  | 500 x 400              | 9355500400    |
|  | Artikelgroep: 07.03.05 |               |

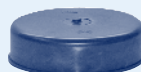


\* SN8

|   | Afmeting in mm         | Artikelnr. |
|---|------------------------|------------|
| <b>9338</b><br><b>PVC Overschuifmof</b> | 32                     | 9338032    |
|   | 40                     | 9338040    |
|   | 50                     | 9338050    |
|   | 75                     | 9338075    |
|   | 110                    | 9338110    |
|   | 125                    | 9338125    |
|   | 160                    | 9338160    |
|   | 200                    | 9338200    |
|   | 250                    | 9338250    |
|   | 315                    | 9338315    |
|   | 400                    | 9338400    |
|   | 500                    | 9338500    |
|   | 630                    | 9338630    |
|   | Artikelgroep: 07.03.05 |            |



|  | Afmeting in mm         | Artikelnr. |
|--|------------------------|------------|
| <b>9318</b><br><b>PVC Eindkap</b><br>- passend over de<br>buis | 32                     | 9318032    |
|  | 40                     | 9318040    |
|  | 50                     | 9318050    |
|  | 60                     | 9318060    |
|  | 70                     | 9318070    |
|  | 75                     | 9318075    |
|  | 80                     | 9318080    |
|  | 90                     | 9318090    |
|  | 100                    | 9318100    |
|  | 110                    | 9318110    |
|  | 125                    | 9318125    |
|  | 160                    | 9318160    |
|  | 200                    | 9318200    |
|  | 250                    | 9318250    |
|  | 315                    | 9318315    |
|  | 400                    | 9318400    |
|  | 500                    | 9318500    |
| 630  | 9318630                |            |
|  | Artikelgroep: 07.03.05 |            |



Voor speciedeksels  
zie blz. 136, artikel-  
nr. 9311.

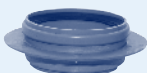
|  | Afmeting in mm         | Artikelnr. |
|--|------------------------|------------|
| <b>9325</b><br><b>PVC Instormof</b><br>met stootrand<br>- zonder flens | 110                    | 9325110    |
|  | 125                    | 9325125    |
|  | 160                    | 9325160    |
|  | 200                    | 9325200    |
|  | 250                    | 9325250    |
|  | 315                    | 9325315    |
|  | 400                    | 9325400    |
|  | 500                    | 9325500    |
|  | 630                    | 9325630    |
|  | Artikelgroep: 07.03.05 |            |



|  | Afmeting in mm         | Artikelnr. |
|--|------------------------|------------|
| <b>9357</b><br><b>PVC Kombikap</b><br>- passend om de<br>buis en in de mof | 110                    | 9357110    |
|  | 125                    | 9357125    |
|  | 160                    | 9357160    |
|  | Artikelgroep: 07.03.05 |            |



|  | Afmeting in mm         | Artikelnr. |
|--|------------------------|------------|
| <b>9325F</b><br><b>PVC Instormof</b><br>met stootrand<br>- met flens | 110                    | 9325110F   |
|  | 125                    | 9325125F   |
|  | 160                    | 9325160F   |
|  | 200                    | 9325200F   |
|  | Artikelgroep: 07.03.05 |            |



|  | Afmeting in mm         | Artikelnr. |
|--|------------------------|------------|
| <b>9336</b><br><b>PVC Bocht 87.5°</b><br>- 2 x mof | 110                    | 933611090  |
|  | 125                    | 933612590  |
|  | 160                    | 933616090  |
|  | 200                    | 933620090  |
|  | 250                    | 933625090  |
|  | 315                    | 933631590  |
|  | 400                    | 933640090  |
|  | Artikelgroep: 07.03.05 |            |




|   | Afmeting in mm         | Artikelnr. |
|---|------------------------|------------|
| <b>9345</b><br><b>PVC Inzet-<br/>verloopring</b><br>- excentrisch<br>- spie x manchet | 125 x 110              | 9345125110 |
|   | 160 x 110              | 9345160110 |
|   | 160 x 125              | 9345160125 |
|   | 200 x 110              | 9345200110 |
|   | 200 x 125              | 9345200125 |
|   | 200 x 160              | 9345200160 |
|   | Artikelgroep: 07.03.05 |            |



|   | Afmeting in mm         | Artikelnr. |
|---|------------------------|------------|
| <b>9335</b><br><b>PVC Bocht 87.5°</b><br>- mof x spie | 110                    | 933511090  |
|   | 125                    | 933512590  |
|   | 160                    | 933516090  |
|   | 200                    | 933520090  |
|   | 250                    | 933525090  |
|   | 315                    | 933531590  |
|   | 400                    | 933540090  |
|   | 500                    | 933550090  |
|   | Artikelgroep: 07.03.05 |            |





## PVC Afvoer manchethulpstukken SN4 (waar van toepassing)

|   | Afmeting in mm | Artikelnr.             |
|---|----------------|------------------------|
| <b>9336</b><br><b>PVC Bocht 45°</b><br>- 2 x mof                                  | 110            | 933611045              |
|   | 125            | 933612545              |
|   | 160            | 933616045              |
|   | 200            | 933620045              |
|   | 250            | 933625045              |
|   | 315            | 933631545              |
|   | 400            | 933640045              |
|  |                | Artikelgroep: 07.03.05 |

|   | Afmeting in mm | Artikelnr.             |
|---|----------------|------------------------|
| <b>9335</b><br><b>PVC Bocht 45°</b><br>- mof x spie                               | 110            | 933511045              |
|   | 125            | 933512545              |
|   | 160            | 933516045              |
|   | 200            | 933520045              |
|   | 250            | 933525045              |
|   | 315            | 933531545              |
|   | 400            | 933540045              |
|   | 500            | 933550045              |
|  |                | Artikelgroep: 07.03.05 |

|   | Afmeting in mm | Artikelnr.             |
|---|----------------|------------------------|
| <b>9336</b><br><b>PVC Bocht 30°</b><br>- 2 x mof                                    | 110            | 933611030              |
|   | 125            | 933612530              |
|   | 160            | 933616030              |
|   | 200            | 933620030              |
|   | 250            | 933625030              |
|   | 315            | 933631530              |
|   | 400            | 933640030              |
|  |                | Artikelgroep: 07.03.05 |

|   | Afmeting in mm | Artikelnr. |
|---|----------------|------------|
| <b>9335</b><br><b>PVC Bocht 30°</b><br>- mof x spie                                 | 110            | 933511030  |
|   | 125            | 933512530  |
|   | 160            | 933516030  |
|   | 200            | 933520030  |
|   | 250            | 933525030  |
|   | 315            | 933531530  |
|   | 400            | 933540030  |
|   |                |            |
|  |                |            |

|   | Afmeting in mm | Artikelnr.             |
|---|----------------|------------------------|
| <b>9336</b><br><b>PVC Bocht 15°</b><br>- 2 x mof                                    | 110            | 933611015              |
|   | 125            | 933612515              |
|   | 160            | 933616015              |
|   | 200            | 933620015              |
|   | 250            | 933625015              |
|   | 315            | 933631515              |
|   | 400            | 933640015              |
|  |                | Artikelgroep: 07.03.05 |

|   | Afmeting in mm | Artikelnr. |
|---|----------------|------------|
| <b>9335</b><br><b>PVC Bocht 15°</b><br>- mof x spie                                 | 110            | 933511015  |
|   | 125            | 933512515  |
|   | 160            | 933516015  |
|   | 200            | 933520015  |
|   | 250            | 933525015  |
|   | 315            | 933531515  |
|   | 400            | 933540015  |
|   |                |            |
|  |                |            |


|   | Afmeting in mm              | Artikelnr. |                        |
|---|-----------------------------|------------|------------------------|
| <b>9340</b><br><b>PVC T-stuk 87.5°</b><br>- 3 x mof | 110 x 40*                   | 9340110041 |                        |
|   | 110 x 50*                   | 9340110051 |                        |
|   | 110 x 75*                   | 9340110076 |                        |
|   | 110 x 110                   | 9340110111 |                        |
|   | 125 x 40*                   | 9340125041 |                        |
|   | 125 x 50*                   | 9340125051 |                        |
|   | 125 x 75*                   | 9340125076 |                        |
|   | 125 x 110                   | 9340125111 |                        |
|   | 125 x 125                   | 9340125126 |                        |
|   | 160 x 110                   | 9340160111 |                        |
|   | 160 x 125                   | 9340160126 |                        |
|   | 160 x 160                   | 9340160161 |                        |
|   | 200 x 125                   | 9340200126 |                        |
|   | 200 x 160                   | 9340200161 |                        |
|   | 200 x 200                   | 9340200201 |                        |
|   | 250 x 125                   | 9340250126 |                        |
|   | 250 x 160                   | 9340250161 |                        |
|   | 250 x 200                   | 9340250201 |                        |
|   | 250 x 250                   | 9340250251 |                        |
|   | 315 x 125                   | 9340315126 |                        |
|   | 315 x 160                   | 9340315161 |                        |
|   | 315 x 200                   | 9340315201 |                        |
|   | 315 x 250                   | 9340315251 |                        |
|   | 315 x 315                   | 9340315316 |                        |
|   | 400 x 400                   | 9340400401 |                        |
|   |                             |            | Artikelgroep: 07.03.05 |
|   | * 2 x Manchet, 1 x lijmmof. |            |                        |

|   | Afmeting in mm | Artikelnr. |
|---|----------------|------------|
| <b>9339</b><br><b>PVC T-stuk 87.5°</b><br>- 2 x mof, 1 x spie | 110 x 110      | 9339110111 |
|   | 125 x 110      | 9339125111 |
|   | 125 x 125      | 9339125126 |
|   | 160 x 110      | 9339160111 |
|   | 160 x 125      | 9339160126 |
|   | 160 x 160      | 9339160161 |
|   | 200 x 200      | 9339200201 |
|   | 250 x 250      | 9339250251 |
|   | 315 x 315      | 9339315316 |
|   |                |            |
| Voor grotere diameters zijn prijs en levertijd op aanvraag.   |                |            |

|   | Afmeting in mm              | Artikelnr. |                        |
|---|-----------------------------|------------|------------------------|
| <b>9340</b><br><b>PVC T-stuk 45°</b><br>- 3 x mof | 110 x 40*                   | 9340110040 |                        |
|   | 110 x 50*                   | 9340110050 |                        |
|   | 110 x 75*                   | 9340110075 |                        |
|   | 110 x 110                   | 9340110110 |                        |
|   | 125 x 40*                   | 9340125040 |                        |
|   | 125 x 50*                   | 9340125050 |                        |
|   | 125 x 75*                   | 9340125075 |                        |
|   | 125 x 110                   | 9340125110 |                        |
|   | 125 x 125                   | 9340125125 |                        |
|   | 160 x 110                   | 9340160110 |                        |
|   | 160 x 125                   | 9340160125 |                        |
|   | 160 x 160                   | 9340160160 |                        |
|   | 200 x 125                   | 9340200125 |                        |
|   | 200 x 160                   | 9340200160 |                        |
|   | 200 x 200                   | 9340200200 |                        |
|   | 250 x 125                   | 9340250125 |                        |
|   | 250 x 160                   | 9340250160 |                        |
|   | 250 x 200                   | 9340250200 |                        |
|   | 250 x 250                   | 9340250250 |                        |
|   | 315 x 125                   | 9340315125 |                        |
|   | 315 x 160                   | 9340315160 |                        |
|   | 315 x 200                   | 9340315200 |                        |
|   | 315 x 250                   | 9340315250 |                        |
|   | 315 x 315                   | 9340315315 |                        |
|   | 400 x 250                   | 9340400250 |                        |
|   | 400 x 315                   | 9340400315 |                        |
|   | 400 x 400                   | 9340400400 |                        |
|   |                             |            | Artikelgroep: 07.03.05 |
|   | * 2 x Manchet, 1 x lijmmof. |            |                        |

# 07.03 Buitenriolering


## PVC Afvoer manchethulpstukken SN4 (waar van toepassing)


|  | Afmeting in mm | Artikelnr.             |
|--|----------------|------------------------|
| <b>9339</b><br><b>PVC T-stuk 45°</b><br>- 2 x mof, 1 x spie<br> | 110 x 110      | 9339110110             |
|  | 125 x 110      | 9339125110             |
|  | 125 x 125      | 9339125125             |
|  | 160 x 110      | 9339160110             |
|  | 160 x 125      | 9339160125             |
|  | 160 x 160      | 9339160160             |
|  | 200 x 160      | 9339200160             |
|  | 200 x 200      | 9339200200             |
|  | 400 x 200      | 9339400200             |
|  |                | Artikelgroep: 07.03.05 |

Grotere diameters op aanvraag.


|  | Afmeting in mm | Artikelnr.             |
|--|----------------|------------------------|
| <b>9341</b><br><b>PVC Dubbel T-stuk 87.5°</b><br>- 3 x mof, 1 x spie<br> | 110            | 9341110111             |
|  | 125            | 9341125126             |
|  | 160            | 9341160161             |
|  |                | Artikelgroep: 07.03.05 |

|   | Afmeting in mm | Artikelnr.             |
|---|----------------|------------------------|
| <b>9341</b><br><b>PVC Dubbel T-stuk 45°</b><br>- 3 x mof, 1 x spie<br> | 110            | 9341110110             |
|   | 125            | 9341125125             |
|   | 160            | 9341160160             |
|   |                | Artikelgroep: 07.03.05 |

|   | Afmeting in mm | Artikelnr.             |
|---|----------------|------------------------|
| <b>9342</b><br><b>PVC Ontstopnings T-stuk</b><br>- met schroefdeksel<br> | 110            | 9342110                |
|   | 125            | 9342125                |
|   | 160            | 9342160                |
|   |                | Artikelgroep: 07.03.05 |

|  | Afmeting in mm | Artikelnr.             |
|--|----------------|------------------------|
| <b>9436</b><br><b>PP bocht draaibaar</b><br>- draaibaar van 0° - 90°<br>- 2 x manchet<br> | 40             | 9436040                |
|  | 110            | 9436110                |
|  | 110 *          | 94361101               |
|  |                | Artikelgroep: 07.03.05 |


\* Manchet x spie

|   | Afmeting in mm | Artikelnr.             |
|---|----------------|------------------------|
| <b>9440</b><br><b>PP T-stuk draaibaar</b><br>- draaibaar van 0° - 90°<br>- 2 x manchet, 1 x spie<br> | 110            | 9440110                |
|   |                | Artikelgroep: 07.03.05 |

|  | Afmeting in mm | Artikelnr.             |
|--|----------------|------------------------|
| <b>9343008</b><br><b>PVC Ontstopnings-stuk</b><br>- met klemdeksel<br>- SN8<br> | 125            | 9343125008             |
|  | 160            | 9343160008             |
|  |                | Artikelgroep: 07.03.10 |

|   | Afmeting in mm | Artikelnr.             |
|---|----------------|------------------------|
| <b>9344</b><br><b>PVC Ontstopnings-stuk</b><br>- met schuifkap<br> | 200            | 9344200                |
|   | 250            | 9344250                |
|   | 315            | 9344315                |
|   |                | Artikelgroep: 07.03.05 |


|  | Afmeting in mm         | Artikelnr. |
|--|------------------------|------------|
| <b>9346</b><br><b>PVC Ontstopnings-stuk</b><br>- met keerklep<br>- kleur: roodbruin<br> | 110                    | 9346110    |
|  | 125                    | 9346125    |
|  | 160                    | 9346160    |
|  | 200                    | 9346200    |
|  | 250                    | 9346250    |
|  | 315                    | 9346315    |
|  | 400                    | 9346400    |
|  | 500                    | 9346500    |
|  | Artikelgroep: 07.03.05 |            |

|  | Afmeting in mm | Artikelnr.             |
|--|----------------|------------------------|
| <b>9354</b><br><b>PVC Zettingsmof</b><br>- max. 10cm zetting<br>- SN8<br> | 125            | 9354125                |
|  | 160            | 9354160                |
|  |                | Artikelgroep: 07.03.10 |


07

## PVC Afvoer manchethulpstukken SN4 (waar van toepassing)

|                        | Afmeting in mm | Artikelnr.             |
|------------------------|----------------|------------------------|
| <b>9460</b>            | 125 gat Ø 130  | 9460125                |
| <b>PVC Betoninlaat</b> | 160 gat Ø 165  | 9460160                |
| - SN8                  |                | Artikelgroep: 07.03.10 |



|                        | Afmeting in mm | Artikelnr.             |
|------------------------|----------------|------------------------|
| <b>9462</b>            | 125 x 151      | 9462125                |
| <b>Betoninlaat SBR</b> | 160 x 186      | 9462160                |
| - H=50mm               | 200 x 226      | 9462200                |
|                        | 250 x 276      | 9462250                |
|                        | 315 x 341      | 9462315                |
|                        | 400 x 426      | 9462400                |
|                        | 500 x 526      | 9462500                |
|                        |                | Artikelgroep: 07.03.10 |



|                         | Afmeting in mm | Artikelnr.             |
|-------------------------|----------------|------------------------|
| <b>9356</b>             | 200 x 125      | 9356200125             |
| <b>PVC Knevelinlaat</b> | 250 x 125      | 9356250125             |
| - met zettings-         | 250 x 160      | 9356250160             |
| constructie voor        | 315 x 125      | 9356315125             |
| buis SN4/SN8            | 315 x 160      | 9356315160             |
| - geschikt voor         | 400 x 125      | 9356400125             |
| SN4/SN8                 | 400 x 160      | 9356400160             |
|                         | 500 x 160      | 9356500160             |
|                         | 630 x 160      | 9356630160             |
|                         |                | Artikelgroep: 07.03.05 |



Voor gat 125 gatzaag 127mm gebruiken.  
Voor gat 160 gatzaag 160mm gebruiken.

|                       | Afmeting in mm | Artikelnr.             |
|-----------------------|----------------|------------------------|
| <b>9351</b>           | 200 x 125      | 9351200125             |
| <b>PVC Keilinlaat</b> | 250 x 125      | 9351250125             |
| - zonder zettingsmof  | 250 x 160      | 9351250160             |
|                       | 315 x 125      | 9351315125             |
|                       | 315 x 160      | 9351315160             |
|                       | 400 x 125      | 9351400125             |
|                       | 400 x 160      | 9351400160             |
|                       | 500 x 125      | 9351500125             |
|                       | 500 x 160      | 9351500160             |
|                       | 630 x 125      | 9351630125             |
|                       | 630 x 160      | 9351630160             |
|                       |                | Artikelgroep: 07.03.05 |



Voor gat 125 gatzaag 133mm gebruiken.  
Voor gat 160 gatzaag 168mm gebruiken.

Voor montagesleutel voor keilinlaat zie groep 21 blz. 290, artikelnr. 93511.

Gatzaag voor knevel- en keilinlaten zie groep 21 blz. 290, artikelnr. 4917.

|                       | Afmeting in mm | Artikelnr.             |
|-----------------------|----------------|------------------------|
| <b>9360</b>           | 110 x 180      | 9360110180             |
| <b>PVC Overgangs-</b> | 125 x 180      | 9360125180             |
| <b>stuk</b>           | 125 x 206      | 9360125206             |
| - PVC op gres         | 160 x 206      | 9360160206             |
| - met overgangs-      |                | Artikelgroep: 07.03.05 |
| manchet               |                |                        |



|                       | Afmeting in mm | Artikelnr.             |
|-----------------------|----------------|------------------------|
| <b>9361</b>           | 110 x 157      | 9361110                |
| <b>PVC Overgangs-</b> | 125 x 157      | 9361125                |
| <b>stuk</b>           | 160 x 184      | 9361160                |
| - PVC op gietijzer    | 200 x 232      | 9361200                |
|                       |                | Artikelgroep: 07.03.05 |



|                        | Afmeting in mm | Artikelnr.             |
|------------------------|----------------|------------------------|
| <b>9364</b>            | 110            | 9364110                |
| <b>Tokrolring</b>      | 120            | 9364125                |
| - voor artikelnr. 9360 | 135            | 9364160                |
| en 9361                | 160            | 9364200                |
|                        |                | Artikelgroep: 07.03.05 |



|                            | Afmeting in mm | Artikelnr.             |
|----------------------------|----------------|------------------------|
| <b>9350</b>                | 110            | 9350110                |
| <b>PVC Flexibele huis-</b> | 125            | 9350125                |
| <b>aansluiting</b>         | 160            | 9350160                |
| - lengte: 2000mm           |                | Artikelgroep: 07.03.05 |
| - inclusief ring en        |                |                        |
| klemband                   |                |                        |



|                     | Afmeting in mm | Artikelnr.             |
|---------------------|----------------|------------------------|
| <b>9450</b>         | 110            | 9450110                |
| <b>PVC Polder-</b>  | 125            | 9450125                |
| <b>expansiestuk</b> | 160            | 9450160                |
|                     | 200            | 9450200                |
|                     |                | Artikelgroep: 07.03.05 |




# 07.03 Buitenriolering


## PVC Afvoer manchethulpstukken SN8 (waar van toepassing)

• Met KOMO-keur (waar van toepassing).

|   | Afmeting in mm | Artikelnr.             |
|---|----------------|------------------------|
| <b>9337008</b><br>PVC Steekmof<br>- met stootrand | 125            | 9337125008             |
|   | 160            | 9337160008             |
|   | 200            | 9337200008             |
|   | 250            | 9337250008             |
|   | 315            | 9337315008             |
|   |                | Artikelgroep: 07.03.10 |



|                                     | Afmeting in mm | Artikelnr.             |
|-------------------------------------|----------------|------------------------|
| <b>9338008</b><br>PVC Overschuifmof | 125            | 9338125008             |
|                                     | 160            | 9338160008             |
|                                     | 200            | 9338200008             |
|                                     | 250            | 9338250008             |
|                                     | 315            | 9338315008             |
|                                     |                | Artikelgroep: 07.03.10 |



|  | Afmeting in mm | Artikelnr.             |
|--|----------------|------------------------|
| <b>9355008</b><br>PVC Verloop<br>- excentrisch<br>- spie x manchet | 125 x 110      | 9355125110008          |
|  | 160 x 110      | 9355160110008          |
|  | 160 x 125      | 9355160125008          |
|  | 200 x 125      | 9355200125008          |
|  | 200 x 160      | 9355200160008          |
|  |                | Artikelgroep: 07.03.10 |




|  | Afmeting in mm | Artikelnr.             |
|--|----------------|------------------------|
| <b>9336008</b><br>PVC Bocht 87.5°<br>- 2 x mof | 125            | 933612590008           |
|  | 160            | 933616090008           |
|  | 200            | 933620090008           |
|  | 250            | 933625090008           |
|  | 315            | 933631590008           |
|  |                | Artikelgroep: 07.03.10 |




|   | Afmeting in mm | Artikelnr.             |
|---|----------------|------------------------|
| <b>9335008</b><br>PVC Bocht 87.5°<br>- mof x spie | 125            | 933512590008           |
|   | 160            | 933516090008           |
|   | 200            | 933520090008           |
|   | 250            | 933525090008           |
|   | 315            | 933531590008           |
|   |                | Artikelgroep: 07.03.10 |




|  | Afmeting in mm | Artikelnr.             |
|--|----------------|------------------------|
| <b>9336008</b><br>PVC Bocht 45°<br>- 2 x mof | 125            | 933612545008           |
|  | 160            | 933616045008           |
|  | 200            | 933620045008           |
|  | 250            | 933625045008           |
|  | 315            | 933631545008           |
|  |                | Artikelgroep: 07.03.10 |




|   | Afmeting in mm | Artikelnr.             |
|---|----------------|------------------------|
| <b>9335008</b><br>PVC Bocht 45°<br>- mof x spie | 125            | 933512545008           |
|   | 160            | 933516045008           |
|   | 200            | 933520045008           |
|   | 250            | 933525045008           |
|   | 315            | 933531545008           |
|   |                | Artikelgroep: 07.03.10 |




|  | Afmeting in mm | Artikelnr.             |
|--|----------------|------------------------|
| <b>9336008</b><br>PVC Bocht 30°<br>- 2 x mof | 125            | 933612530008           |
|  | 160            | 933616030008           |
|  |                | Artikelgroep: 07.03.10 |




|   | Afmeting in mm | Artikelnr.             |
|---|----------------|------------------------|
| <b>9335008</b><br>PVC Bocht 30°<br>- mof x spie | 125            | 933512530008           |
|   | 160            | 933516030008           |
|   |                | Artikelgroep: 07.03.10 |



|  | Afmeting in mm | Artikelnr.             |
|--|----------------|------------------------|
| <b>9336008</b><br>PVC Bocht 15°<br>- 2 x mof | 125            | 933612515008           |
|  | 160            | 933616015008           |
|  |                | Artikelgroep: 07.03.10 |




|   | Afmeting in mm | Artikelnr.             |
|---|----------------|------------------------|
| <b>9335008</b><br>PVC Bocht 15°<br>- mof x spie | 125            | 933512515008           |
|   | 160            | 933516015008           |
|   |                | Artikelgroep: 07.03.10 |




07

## PVC Afvoer manchethulpstukken SN8 (waar van toepassing)


|                        | Afmeting in mm | Artikelnr.             |
|------------------------|----------------|------------------------|
| <b>9354</b>            | 125            | 9354125                |
| <b>PVC Zettingsmof</b> | 160            | 9354160                |
| - max. 10cm zetting    |                | Artikelgroep: 07.03.10 |
| - SN8                  |                |                        |




|                        | Afmeting in mm | Artikelnr.             |
|------------------------|----------------|------------------------|
| <b>9460</b>            | 125 gat Ø 130  | 9460125                |
| <b>PVC Betoninlaat</b> | 160 gat Ø 165  | 9460160                |
| - SN8                  |                | Artikelgroep: 07.03.10 |




|                        | Afmeting in mm | Artikelnr.             |
|------------------------|----------------|------------------------|
| <b>9462</b>            | 125 x 151      | 9462125                |
| <b>Betoninlaat SBR</b> | 160 x 186      | 9462160                |
| - H=50mm               | 200 x 226      | 9462200                |
|                        | 250 x 276      | 9462250                |
|                        | 315 x 341      | 9462315                |
|                        | 400 x 426      | 9462400                |
|                        | 500 x 526      | 9462500                |
|                        |                | Artikelgroep: 07.03.10 |



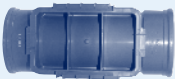
|                         | Afmeting in mm | Artikelnr.             |
|-------------------------|----------------|------------------------|
| <b>9340008</b>          | 125 x 125      | 9340125126008          |
| <b>PVC T-stuk 87.5°</b> | 160 x 125      | 9340160126008          |
| - 3 x mof               | 160 x 160      | 9340160161008          |
|                         | 200 x 125      | 9340200126008          |
|                         | 200 x 160      | 9340200161008          |
|                         | 200 x 200      | 9340200201008          |
|                         |                | Artikelgroep: 07.03.10 |



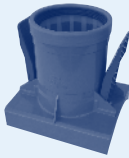
|                       | Afmeting in mm | Artikelnr.             |
|-----------------------|----------------|------------------------|
| <b>9340008</b>        | 125 x 125      | 9340125125008          |
| <b>PVC T-stuk 45°</b> | 160 x 125      | 9340160125008          |
| - 3 x mof             | 160 x 160      | 9340160160008          |
|                       | 200 x 125      | 9340200125008          |
|                       | 200 x 160      | 9340200160008          |
|                       | 200 x 200      | 9340200200008          |
|                       |                | Artikelgroep: 07.03.10 |



|                            | Afmeting in mm | Artikelnr.             |
|----------------------------|----------------|------------------------|
| <b>9343008</b>             | 125            | 9343125008             |
| <b>PVC Ontstoppings-</b>   | 160            | 9343160008             |
| <b>stuk met klemdeksel</b> |                | Artikelgroep: 07.03.10 |




|                         | Afmeting in mm | Artikelnr.             |
|-------------------------|----------------|------------------------|
| <b>9356</b>             | 200 x 125      | 9356200125             |
| <b>PVC Knevelinlaat</b> | 250 x 125      | 9356250125             |
| - met zettings-         | 250 x 160      | 9356250160             |
| constructie voor        | 315 x 125      | 9356315125             |
| buis SN4/SN8            | 315 x 160      | 9356315160             |
| - geschikt voor         | 400 x 125      | 9356400125             |
| SN4/SN8                 | 400 x 160      | 9356400160             |
|                         | 500 x 160      | 9356500160             |
|                         | 630 x 160      | 9356630160             |
|                         |                | Artikelgroep: 07.03.05 |




Voor gat 125 gatzaag 127mm gebruiken.  
Voor gat 160 gatzaag 160mm gebruiken.

Voor keilinlaat zie blz. 147, artikelnr. 9351.

|                      | Afmeting in mm | Artikelnr.             |
|----------------------|----------------|------------------------|
| <b>9348</b>          | 125            | 9348125                |
| <b>PVC Flexibele</b> | 160            | 9348160                |
| <b>steekmof</b>      |                | Artikelgroep: 07.03.10 |
| - SN8                |                |                        |



|                      | Afmeting in mm | Artikelnr.             |
|----------------------|----------------|------------------------|
| <b>9353</b>          | 125            | 9353125                |
| <b>PVC Flexibele</b> | 160            | 9353160                |
| <b>bocht 90°</b>     |                | Artikelgroep: 07.03.10 |
| - SN8                |                |                        |



|                       | Afmeting in mm | Artikelnr.             |
|-----------------------|----------------|------------------------|
| <b>9347</b>           | 125            | 9347125                |
| <b>PVC Flexibel</b>   |                | Artikelgroep: 07.03.10 |
| <b>stroom T-stuk</b>  |                |                        |
| - 3 x mof met zetting |                |                        |
| - SN8                 |                |                        |



|                     | Afmeting in mm | Artikelnr.             |
|---------------------|----------------|------------------------|
| <b>9349</b>         | 125            | 9349125                |
| <b>PVC Flexibel</b> | 160            | 9349160                |
| <b>T-stuk 90°</b>   |                | Artikelgroep: 07.03.10 |
| - 2 x mof, 1 x spie |                |                        |
| - SN8               |                |                        |



# 07.03 Buitenriolering

## PVC Regenwaterafvoer hulpstukken

- Standaard kleur: grijs.

|                                  | Afmeting in mm | Artikelnr. |
|----------------------------------|----------------|------------|
| <b>9370</b>                      | 60             | 9370060    |
| <b>PVC Verbindings-<br/>stuk</b> | 70             | 9370070    |
| - mof x verj. spie               | 80 *           | 9370080    |
|                                  | 100            | 9370100    |


Artikelgroep: 07.03.15



\* Artikelnr. 93702080: RWA overschuifmof 80mm.

|                      | Afmeting in mm | Artikelnr. |
|----------------------|----------------|------------|
| <b>9366</b>          | 60             | 936606090  |
| <b>PVC Bocht 87°</b> | 70             | 936607090  |
| - mof x verj. spie   | 80             | 936608090  |
|                      | 100            | 936610090  |

Artikelgroep: 07.03.15



|                        | Afmeting in mm | Artikelnr. |
|------------------------|----------------|------------|
| <b>9367</b>            | 70 x 60        | 9367070060 |
| <b>PVC Verloopstuk</b> | 75 x 60        | 9367075060 |
| - spie x mof           | 75 x 70        | 9367075070 |
|                        | 80 x 60        | 9367080060 |
|                        | 80 x 70        | 9367080070 |
|                        | 80 x 75 *      | 9367080075 |
|                        | 100 x 70       | 9367100070 |
|                        | 100 x 80       | 9367100080 |
|                        | 110 x 70       | 9367110070 |
|                        | 110 x 80       | 9367110080 |
|                        | 110 x 100      | 9367110100 |
|                        | 125 x 80       | 9367125080 |
|                        | 125 x 100      | 9367125100 |

Artikelgroep: 07.03.15



\* mof x spie

|                      | Afmeting in mm | Artikelnr. |
|----------------------|----------------|------------|
| <b>93660</b>         | 60             | 9366060450 |
| <b>PVC Bocht 45°</b> | 70             | 9366070450 |
| - mof x spie         | 80             | 9366080450 |
|                      | 100            | 9366100450 |

Artikelgroep: 07.03.15




|                                   | Afmeting in mm | Artikelnr. |
|-----------------------------------|----------------|------------|
| <b>9369</b>                       | 60 x 50        | 9369060050 |
| <b>PVC Inzet-<br/>verloopring</b> | 70 x 50        | 9369070050 |
| - spie x mof                      | 70 x 60        | 9369070060 |
|                                   | 75 x 70        | 9369075070 |
|                                   | 80 x 50        | 9369080050 |
|                                   | 80 x 70        | 9369080070 |
|                                   | 80 x 75        | 9369080075 |
|                                   | 100 x 70       | 9369100070 |
|                                   | 100 x 75       | 9369100075 |
|                                   | 100 x 80       | 9369100080 |
|                                   | 110 x 70       | 9369110070 |
|                                   | 110 x 80       | 9369110080 |
|                                   | 110 x 100      | 9369110100 |
|                                   | 125 x 80       | 9369125080 |
|                                   | 125 x 100      | 9369125100 |

Artikelgroep: 07.03.15




|                      | Afmeting in mm | Artikelnr. |
|----------------------|----------------|------------|
| <b>9366</b>          | 60             | 936606045  |
| <b>PVC Bocht 45°</b> | 70             | 936607045  |
| - mof x verj. spie   | 80             | 936608045  |
|                      | 100            | 936610045  |

Artikelgroep: 07.03.15



|                      | Afmeting in mm | Artikelnr. |
|----------------------|----------------|------------|
| <b>93660</b>         | 60             | 9366060900 |
| <b>PVC Bocht 87°</b> | 70             | 9366070900 |
| - mof x spie         | 80             | 9366080900 |
|                      | 100            | 9366100900 |

Artikelgroep: 07.03.15



|                      | Afmeting in mm | Artikelnr. |
|----------------------|----------------|------------|
| <b>93660</b>         | 70             | 9366070220 |
| <b>PVC Bocht 22°</b> | 80             | 9366080220 |
| - mof x spie         | 100            | 9366100220 |

Artikelgroep: 07.03.15



07

## PVC Regenwaterafvoer hulpstukken

|                        | Afmeting in mm | Artikelnr.             |
|------------------------|----------------|------------------------|
| <b>9368</b>            | 60             | 936806090              |
| <b>PVC T-stuk 87°</b>  | 70             | 936807090              |
| - 2 x mof x verj. spie | 80             | 936808090              |
|                        | 100            | 936810090              |
|                        |                | Artikelgroep: 07.03.15 |




|                      | Afmeting in mm | Artikelnr.             |
|----------------------|----------------|------------------------|
| <b>9373</b>          | 80/70          | 9373080                |
| <b>PVC Kiezelbak</b> | 100/80         | 9373100                |
| - type ZZ            |                | Artikelgroep: 07.03.15 |




|                        | Afmeting in mm | Artikelnr.             |
|------------------------|----------------|------------------------|
| <b>9368</b>            | 60             | 936806045              |
| <b>PVC T-stuk 45°</b>  | 70             | 936807045              |
| - 2 x mof x verj. spie | 80             | 936808045              |
|                        | 100            | 936810045              |
|                        |                | Artikelgroep: 07.03.15 |



|                         | Afmeting in mm | Artikelnr.             |
|-------------------------|----------------|------------------------|
| <b>9374</b>             | 80/70          | 9374080                |
| <b>PVC Stadsuitloop</b> | 100/80         | 9374100                |
| - voor kiezelbak        |                | Artikelgroep: 07.03.15 |
| type ZZ                 |                |                        |



|                       | Afmeting in mm | Artikelnr.             |
|-----------------------|----------------|------------------------|
| <b>9371</b>           | 70/80/100      | 9371                   |
| <b>PVC Bladvanger</b> | 80             | 9376080                |
|                       |                | Artikelgroep: 07.03.15 |



|                             | Afmeting in mm | Artikelnr.             |
|-----------------------------|----------------|------------------------|
| <b>9377</b>                 | 80 x 80        | 9377080                |
| <b>PVC Regenwater-sifon</b> |                | Artikelgroep: 07.03.15 |
| - type A                    |                |                        |
| - met ontstopping           |                |                        |



|                       | Afmeting in mm | Artikelnr.             |
|-----------------------|----------------|------------------------|
| <b>9375</b>           | 80/100         | 9375                   |
| <b>PVC Vergaarbak</b> |                | Artikelgroep: 07.03.15 |



|                             | Afmeting in mm | Artikelnr.             |
|-----------------------------|----------------|------------------------|
| <b>9378</b>                 | 110 x 100*     | 9378110                |
| <b>PVC Regenwater-sifon</b> |                | Artikelgroep: 07.03.15 |
| - type B                    |                |                        |
| - met ontstopping 110mm     |                |                        |



\* Artikelnr. 930411067:  
bijbehorende bocht lijmmof x spie 110mm 67°.

07





## PVC Straat- en trottoirkolken

- Voor ons uitgebreide assortiment kolken, putten en deksels verwijzen wij u naar Groep 9 'Milieu programma'.

|  | Afmeting in mm | Artikelnr.                     |
|--|----------------|--------------------------------|
| <b>9531</b><br><b>PE Straat- / trottoirkolk</b><br>- type M94PK<br>- met uitlaat 125mm<br>- hoogte: 730mm<br>- met speciaal aangegoten sifonsysteem<br>- met controle- / ontstopingsmogelijkheid | 315            | 9531<br>Artikelgroep: 09.01.15 |



|   | Afmeting in mm | Artikelnr.                     |
|---|----------------|--------------------------------|
| <b>9352</b><br><b>PVC Onderbak</b><br>- met uitlaat 125mm<br>- met sifonsysteem | 315            | 9352<br>Artikelgroep: 07.03.25 |

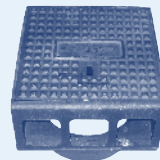


Artikelnr. 95051: PVC Verhogingsring 315mm, hoogte 30, 50, 70, 100, 120, 140, 150, 200, 300, 500 en 1000mm.

|  | Klasse | Artikelnr.                      |
|--|--------|---------------------------------|
| <b>9501M</b><br><b>Gietijzer straatkop</b><br>- beschikbaar in klasse:<br>B125 en D400 | B125   | 9501M125                        |
|  | D400   | 9501M<br>Artikelgroep: 09.02.10 |



|   | Artikelnr.                     |
|---|--------------------------------|
| <b>9502</b><br><b>Gietijzer trottoirkop</b> | 9502<br>Artikelgroep: 09.02.10 |



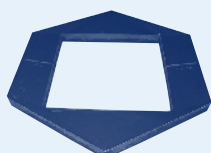
|   | Artikelnr.                      |
|---|---------------------------------|
| <b>95010</b><br><b>Gietijzer molgootkop</b> | 95010<br>Artikelgroep: 09.02.10 |



|   | Artikelnr.                     |
|---|--------------------------------|
| <b>9507</b><br><b>Gietijzer trottoirkop</b><br>- type 'RWS' | 9507<br>Artikelgroep: 09.02.10 |



|   | Artikelnr.                     |
|---|--------------------------------|
| <b>9503</b><br><b>Gietijzer zeskantegel</b><br>- voor straatkop | 9503<br>Artikelgroep: 09.02.10 |



|  | Artikelnr.                     |
|--|--------------------------------|
| <b>9508</b><br><b>Gietijzer vijfkantegel</b><br>- voor straatkop | 9508<br>Artikelgroep: 09.02.10 |



# 07.03 Buitenriolering

## PVC Straat- en trottoirkolken

|  | Afmeting in mm         | Aansluiting | Artikelnr. |
|--|------------------------|-------------|------------|
| <b>9532</b><br><b>PP Controleput PK 315</b><br>- hoogte: 430mm<br>- met stroomprofiel<br>- inclusief kunststof deksel met rubber afdichting<br>- aansluitingen zijn voorzien van manchet<br>- in hoogte verstelbaar d.m.v.<br>PVC Buis 315, artikelnr. 95091 | 315                    | 2 x 125     | 9532125    |
|  | 315                    | 2 x 160     | 9532160    |
|  | 315                    | 2 x 200     | 9532200    |
|  | Artikelgroep: 09.01.15 |             |            |



|  | Artikelnr.                      |
|--|---------------------------------|
| <b>95321</b><br><b>Deksel voor PP controleput PK 315</b><br>- kleur: zwart | 95321<br>Artikelgroep: 09.02.05 |



Artikelnr. 95322: Deksel voor PE controleput PK 315 roodbruin.

|  | Afmeting in mm         | Aansluiting | Artikelnr. |
|--|------------------------|-------------|------------|
| <b>9509</b><br><b>PVC Controleput</b><br>- in hoogte verstelbaar d.m.v.<br>artikelnr. 95093151, PVC Buis 315 | 315                    | 2 x 125     | 9509125    |
|  | 315                    | 2 x 160     | 9509160    |
|  | Artikelgroep: 07.03.25 |             |            |



\* Artikelnr. 95090: PVC Efscheidingsput met ingebouwd stroomprofiel.

|   | Artikelnr.                         |
|---|------------------------------------|
| <b>95091</b><br><b>PVC Buis 315</b><br>- lengte: 1000mm<br>- voor verhogen controle- of efscheidingsput | 95093151<br>Artikelgroep: 07.03.25 |



|   | Afmeting in mm | Artikelnr.                     |
|---|----------------|--------------------------------|
| <b>9517</b><br><b>PVC Tegelpadkolk</b><br>- met uitlaat 125mm | 250            | 9517<br>Artikelgroep: 07.03.25 |



|   | Artikelnr.                      |
|---|---------------------------------|
| <b>95092</b><br><b>Gietijzer deksel en rand</b><br>- voor efscheidingsput,<br>artikelnr. 9509<br>- voor licht verkeer | 95092<br>Artikelgroep: 09.02.10 |



|   | Artikelnr.                       |
|---|----------------------------------|
| <b>95171</b><br><b>Gietijzer tegelpadkop</b><br>- 300 x 300mm<br>- scharnierend | 95171B<br>Artikelgroep: 09.02.10 |



## Lijm en reiniger voor afvoerleiding

|                            | Inhoud in ml | Artikelnr.             |
|----------------------------|--------------|------------------------|
| <b>171288</b>              | pot 100      | 1712880100             |
| <b>T-88 lijm met kwast</b> | pot 250      | 1712880250             |
| - voor het verlijmen       | pot 500      | 1712880500             |
| van afvoer- en             | pot 1000     | 1712881000             |
| drukleidingen              | blik 5000*   | 1712885000             |
| - KIWA/ATA keur            |              | Artikelgroep: 19.01.05 |



\* Zonder kwast.

|                  | Inhoud in kg | Artikelnr.             |
|------------------|--------------|------------------------|
| <b>1760</b>      | 15           | 1760                   |
| <b>Moffenkit</b> |              | Artikelgroep: 19.01.10 |



|                         | Inhoud in ml | Artikelnr.             |
|-------------------------|--------------|------------------------|
| <b>1713</b>             | blik 125     | 171300125              |
| <b>Griffon reiniger</b> | blik 500     | 171300500              |
| - voor het reinigen     | blik 1000    | 171301000              |
| van PVC/C-PVC           | blik 5000    | 171305000              |
|                         |              | Artikelgroep: 19.01.05 |





|                            | Inhoud in gram | Artikelnr.             |
|----------------------------|----------------|------------------------|
| <b>1729</b>                | knijpfles 250  | 1729250                |
| <b>Glijmiddel Blue Gel</b> |                | Artikelgroep: 19.01.05 |



|                      | Inhoud in gram | Artikelnr.             |
|----------------------|----------------|------------------------|
| <b>1714</b>          | pot 700        | 1714700                |
| <b>Glijmiddel</b>    | pot 4000       | 1714999                |
| - voor fittingen met |                | Artikelgroep: 19.01.05 |
| manchetverbinding    |                |                        |
| - universeel         |                |                        |



|  | Afmeting in mm | Artikelnr.             |
|--|----------------|------------------------|
| <b>1727</b>  | 30             | 1727030                |
| <b>Kwast</b>   | 50             | 1727050                |
| - plat model   |                |                        |
|  |                |                        |
| <b>1727</b>  | 10             | 1727010                |
| <b>Kwast</b>   | 12             | 1727012                |
| - rond model   | 16             | 1727016                |
|  | 18             | 1727018                |
|  | 20             | 1727020                |
|  |                | Artikelgroep: 19.02.05 |
|  |                |                        |

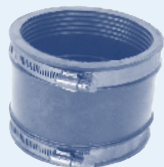
Voor ons complete assortiment lijm en reiniger, zie Groep 19 'Lijm, reiniger en toebehoren'.

# 07.03 Buitenriolering

## Flexkoppelingen

- Voor drukloze leidingen.
- RVS klembanden als bevestiging.
- Geschikt voor het verbinden van bijvoorbeeld PVC, HDPE, gresbuis, keramische buis, staal, gietijzer, koper, beton en lood.

|  | Bereik in mm    | Artikelnr.             |
|--|-----------------|------------------------|
| <b>9410F</b><br>Flexkoppeling PVC Elastomeer | 42 - 30 (42)    | 9410F042030            |
|  | 50 - 40 (50)    | 9410F050040            |
|  | 63 - 50 (63)    | 9410F063050            |
|  | 70 - 60 (68)    | 9410F070060            |
|  | 90 - 75 (90)    | 9410F090075            |
|  | 97 - 85 (95)    | 9410F097085            |
|  | 115 - 98 (112)  | 9410F115098            |
|  | 125 - 110 (122) | 9410F125110            |
|  | 133 - 118 (130) | 9410F133118            |
|  | 168 - 145       | 9410F168145            |
|  | 219 - 199       | 9410F219199            |
|  | 260 - 245       | 9410F260245            |
|  | 320 - 300       | 9410F320300            |
|  |                 | Artikelgroep: 07.03.40 |



|  | Bereik in mm                    | Artikelnr.             |
|--|---------------------------------|------------------------|
| <b>9411F</b><br>Flex verloopkoppeling PVC Elastomeer | 50 - 40 / 33 - 24 (50-32)*      | 9411F050032            |
|  | 87 - 75 / 61 - 50 (85-58)*      | 9411F087061            |
|  | 90 - 75 / 63 - 50 (90-63)*      | 9411F090163            |
|  | 125 - 110 / 114 - 98 (122-112)* | 9411F125114            |
|  | 163 - 155 / 111 - 101           | 9411F163111            |
|  | 168 - 145 / 115 - 98            | 9411F168115            |
|  | 168 - 145 / 143 - 125           | 9411F168143            |
|  | 184 - 175 / 133 - 125           | 9411F184133            |
|  | 187 - 177 / 111 - 101           | 9411F187111            |
|  | 190 - 177 / 162 - 150           | 9411F190262            |
|  | 221 - 203 / 160 - 145           | 9411F221160            |
|  | 232 - 210 / 219 - 198           | 9411F232219            |
|  | 280 - 260 / 270 - 250           | 9411F280270            |
|  |                                 | Artikelgroep: 07.03.40 |



\* Kleur lichtgrijs.

|                                   | Bereik in mm           | Artikelnr.  |
|-----------------------------------|------------------------|-------------|
| <b>9412F</b><br>Flexkoppeling NBR | 75 - 60 NBR            | 9412F075060 |
|                                   | 95 - 80 NBR            | 9412F095080 |
|                                   | 115 - 100 NBR          | 9412F115100 |
|                                   | 121 - 110 NBR          | 9412F121110 |
|                                   | 125 - 110 NBR          | 9412F125110 |
|                                   | 137 - 120 NBR          | 9412F137120 |
|                                   | 175 - 150 NBR          | 9412F175150 |
|                                   | 225 - 200 NBR          | 9412F225200 |
|                                   | 320 - 300 NBR          | 9412F320300 |
|                                   | 335 - 310 NBR          | 9412F335310 |
|                                   | Artikelgroep: 07.03.40 |             |

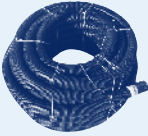


|   | Bereik in mm              | Artikelnr.             |
|---|---------------------------|------------------------|
| <b>9413F</b><br>Flex verloopkoppeling NBR | 122 - 110 / 68 - 60 NBR   | 9413F122068            |
|   | 122 - 110 / 95 - 80 NBR   | 9413F122095            |
|   | 136 - 121 / 121 - 110 NBR | 9413F136121            |
|   | 170 - 155 / 125 - 110 NBR | 9413F170125            |
|   | 192 - 170 / 122 - 110 NBR | 9413F192122            |
|   | 265 - 240 / 215 - 190 NBR | 9413F265215            |
|   | 320 - 295 / 265 - 240 NBR | 9413F320265            |
|   |                           | Artikelgroep: 07.03.40 |





## Drainagebuis

- Kleur: zwart.
- Zeer flexibel.
- Weerstand tegen afplatting.
- Hoge trekvastheid.
- Gering in gewicht.
- Voor het bestellen van de gewenste lengten het volgende aan het artikelnr. toevoegen:  
... = 020, 025, 050, 100, 150, 200 (lengte 20, 25, 50, 100, 150 en 200 meter)

|  | Afmeting in mm | Rollengte in meter | Artikelnr.  |
|--|----------------|--------------------|-------------|
| <b>9020</b><br><b>PE Drainage buis</b><br>- enkelwandig<br>- kaal/blind<br> | 50             | 50 en 200          | 90200500... |
|  | 60             | 50 en 150          | 90200600... |
|  | 65             | 50 en 150          | 90200650... |
|  | 80             | 50 en 100          | 90200800... |
|  | 100            | 50                 | 9020100050  |
|  | 125            | 50                 | 90201250050 |
|  | 160            | 50                 | 90201600050 |
|  |                |                    |             |

|   | Afmeting in mm | Rollengte in meter | Artikelnr.  |
|---|----------------|--------------------|-------------|
| <b>90201</b><br><b>PE Drainage buis</b><br>- enkelwandig<br>- kaal/geperforeerd<br> | 50             | 50 en 200          | 90200501... |
|   | 60             | 50 en 150          | 90200601... |
|   | 65             | 50 en 150          | 90200651... |
|   | 80             | 50 en 100          | 90200801... |
|   | 100            | 50                 | 90201001050 |
|   | 125            | 50                 | 90201251050 |
|   | 160            | 50                 | 90201601050 |
|   |                |                    |             |

|  | Afmeting in mm | Rollengte in meter | Artikelnr. |
|--|----------------|--------------------|------------|
| <b>9030</b><br><b>PE Drainage buis</b><br>- enkelwandig<br>- omwikkeld met kokos (750 gr/m <sup>2</sup> )<br> | 50             | 50 en 200          | 9030050... |
|  | 60             | 50 en 150          | 9030060... |
|  | 65             | 50 en 150          | 9030065... |
|  | 80             | 50 en 100          | 9030080... |
|  | 100            | 50                 | 9030100050 |
|  | 125            | 50                 | 9030125050 |
|  | 160            | 25                 | 9030160025 |
|  | 200            | 20                 | 9030200020 |
|  |                |                    |            |

|  | Afmeting in mm | Rollengte in meter | Artikelnr. |
|--|----------------|--------------------|------------|
| <b>9540</b><br><b>PE Drainagebuis</b><br>- enkelwandig<br>- omwikkeld met PP450<br> | 50             | 50 en 200          | 9540050... |
|  | 60             | 50 en 150          | 9540060... |
|  | 65             | 50 en 150          | 9540065... |
|  | 80             | 50 en 100          | 9540080... |
|  | 100            | 50                 | 9540100050 |
|  | 125            | 50                 | 9540125050 |
|  | 160            | 25                 | 9540160025 |
|  |                |                    |            |

# 07.04 Drainage

## Drainage hulpstukken

• PP-PVC (waar van toepassing).

|                    | Afmeting in mm | Artikelnr.             |
|--------------------|----------------|------------------------|
| <b>9021</b><br>Mof | 50             | 9021050                |
|                    | 60             | 9021060                |
|                    | 65             | 9021065                |
|                    | 80             | 9021080                |
|                    | 100            | 9021100                |
|                    | 125            | 9021125                |
|                    | 160            | 9021160                |
|                    |                | Artikelgroep: 07.04.10 |



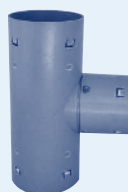
|                           | Afmeting in mm | Artikelnr.             |
|---------------------------|----------------|------------------------|
| <b>9022</b><br>T-stuk 90° | 50             | 9022050                |
|                           | 60             | 9022060                |
|                           | 65             | 9022065                |
|                           | 80             | 9022080                |
|                           | 100            | 9022100                |
|                           | 125            | 9022125                |
|                           | 160            | 9022160                |
|                           |                | Artikelgroep: 07.04.10 |



|                                 | Afmeting in mm | Artikelnr.             |
|---------------------------------|----------------|------------------------|
| <b>9024</b><br>Verloopkoppeling | 60 x 50        | 9024060050             |
|                                 | 65 x 50        | 9024065050             |
|                                 | 65 x 60        | 9024065060             |
|                                 | 80 x 50        | 9024080050             |
|                                 | 80 x 60        | 9024080060             |
|                                 | 80 x 65        | 9024080065             |
|                                 | 100 x 80       | 9024100080             |
|                                 | 125 x 80       | 9024125080             |
|                                 | 125 x 100      | 9024125100             |
|                                 |                | Artikelgroep: 07.04.10 |



|                                   | Afmeting in mm | Artikelnr.             |
|-----------------------------------|----------------|------------------------|
| <b>9023</b><br>Verloop T-stuk 90° | 80 x 50        | 9023080050             |
|                                   | 80 x 60        | 9023080060             |
|                                   | 80 x 65        | 9023080065             |
|                                   | 100 x 60       | 9023100060             |
|                                   | 100 x 80       | 9023100080             |
|                                   | 125 x 50       | 9023125050             |
|                                   | 125 x 60       | 9023125060             |
|                                   | 125 x 65       | 9023125065             |
|                                   | 125 x 80       | 9023125080             |
|                                   | 125 x 100      | 9023125100             |
|                                   | 160 x 60       | 9023160060             |
|                                   | 160 x 100      | 9023160100             |
|                                   |                | Artikelgroep: 07.04.10 |



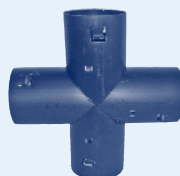
|  | Afmeting in mm | Artikelnr.             |
|--|----------------|------------------------|
| <b>9032</b><br>Verloopkoppeling<br>- spie x klikverbinding | 110 x 80       | 9032110080             |
|  | 110 x 100      | 9032110100             |
|  | 125 x 80       | 9032125080             |
|  | 125 x 100      | 9032125100             |
|  |                | Artikelgroep: 07.04.10 |



|                        | Afmeting in mm | Artikelnr.             |
|------------------------|----------------|------------------------|
| <b>9026</b><br>Eindkap | 50             | 9026050                |
|                        | 60             | 9026060                |
|                        | 65             | 9026065                |
|                        | 80             | 9026080                |
|                        | 100            | 9026100                |
|                        | 125            | 9026125                |
|                        | 160            | 9026160                |
|                        |                | Artikelgroep: 07.04.10 |



|                              | Afmeting in mm | Artikelnr.             |
|------------------------------|----------------|------------------------|
| <b>9025</b><br>Kruisstuk 90° | 60             | 9025060                |
|                              | 65             | 9025065                |
|                              | 80             | 9025080                |
|                              | 100            | 9025100                |
|                              |                | Artikelgroep: 07.04.10 |



Taludgoten en klik buizen zijn op aanvraag leverbaar.

## PVC Drainageputten

• Om de door u gewenste uitvoering exact weer te geven dient u gebruik te maken van een puttenstaat (zie blz. 159). Deze puttenstaat is ook te downloaden vanaf onze internetsite [www.milder.nl](http://www.milder.nl) of kan via e-mail aan u worden toegezonden.

|   | Afmeting in mm | Artikelnr.             |
|---|----------------|------------------------|
| <b>9505</b><br>PVC Drainageputten<br>- leverbaar in diverse hoogten<br>- aansluitingmogelijkheden: manchetmof, spie, klikmof en doorspuitarm<br>- putten zijn voorzien van een PVC deksel | 315            | 95050315               |
|   | 400            | 95050400               |
|   | 500            | 95050500               |
|   |                | Artikelgroep: 07.04.15 |



Artikelnr. 95051: PVC Verhogingsring 315mm, hoogte 30, 50, 70, 100, 120, 140, 150, 200, 300, 500 en 1000mm.

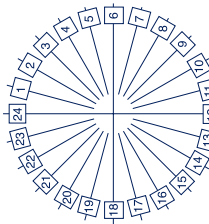
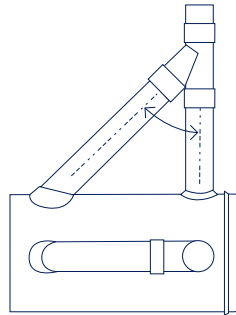
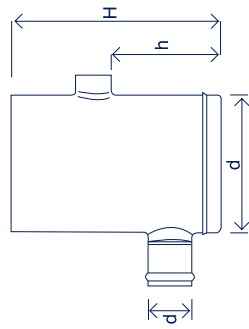
# PVC/PE Drainageputten

Puttype: Vlakke bodem

# Milder

— VEELZIJDIG IN LEIDINGSYSTEMEN —

**Put diameter (D):** 315 / 400 / 500mm  
**Materiaal:** PVC / PE  
**Deksel:** geen / PVC / polyester  
 (doorhalen wat niet van toepassing is)



Richtlijn hartlijn in bovenaanzicht

**Milder Bemmel**

Telefoon 026 - 325 91 03

**Milder Rotterdam**

Telefoon 010 - 415 99 83

E-mail info@milder.nl

Internet www.milder.nl

04-2017

| Put nr. | Aantal | Hoogte<br>mm (H) | Aansluiting 1         |      |                     |          | Aansluiting 2         |      |                     |          | Aansluiting 3         |      |                     |          | Aansluiting 4         |      |                     |          |
|---------|--------|------------------|-----------------------|------|---------------------|----------|-----------------------|------|---------------------|----------|-----------------------|------|---------------------|----------|-----------------------|------|---------------------|----------|
|         |        |                  | Diameter<br>(d) in mm | Type | Hoogte<br>(h) in mm | Richting | Diameter<br>(d) in mm | Type | Hoogte<br>(h) in mm | Richting | Diameter<br>(d) in mm | Type | Hoogte<br>(h) in mm | Richting | Diameter<br>(d) in mm | Type | Hoogte<br>(h) in mm | Richting |
|         |        |                  |                       |      |                     |          |                       |      |                     |          |                       |      |                     |          |                       |      |                     |          |
|         |        |                  |                       |      |                     |          |                       |      |                     |          |                       |      |                     |          |                       |      |                     |          |
|         |        |                  |                       |      |                     |          |                       |      |                     |          |                       |      |                     |          |                       |      |                     |          |
|         |        |                  |                       |      |                     |          |                       |      |                     |          |                       |      |                     |          |                       |      |                     |          |
|         |        |                  |                       |      |                     |          |                       |      |                     |          |                       |      |                     |          |                       |      |                     |          |
|         |        |                  |                       |      |                     |          |                       |      |                     |          |                       |      |                     |          |                       |      |                     |          |
|         |        |                  |                       |      |                     |          |                       |      |                     |          |                       |      |                     |          |                       |      |                     |          |
|         |        |                  |                       |      |                     |          |                       |      |                     |          |                       |      |                     |          |                       |      |                     |          |
|         |        |                  |                       |      |                     |          |                       |      |                     |          |                       |      |                     |          |                       |      |                     |          |
|         |        |                  |                       |      |                     |          |                       |      |                     |          |                       |      |                     |          |                       |      |                     |          |
|         |        |                  |                       |      |                     |          |                       |      |                     |          |                       |      |                     |          |                       |      |                     |          |
|         |        |                  |                       |      |                     |          |                       |      |                     |          |                       |      |                     |          |                       |      |                     |          |

**Altijd achter aansluitdiameter het type vermelden t.w.:**  
 Manchetmof: MM  
 Spie: SP  
 Klikmof: KM  
 Indien een doorspuitarm vereist is, achter het type 'DS' vermelden.

**Puthoogte H:** Totale puthoogte

**Aansluithoogte h:** Gemeten van onderkant put tot binnen-  
 onderkant aansluiting

**Opmerkingen:**

**Voor akkoord opdrachtgever:**

Bedrijfsnaam: \_\_\_\_\_ Handtekening: \_\_\_\_\_

Contactpersoon: \_\_\_\_\_

Telefoonnr.: \_\_\_\_\_

**Verzendadres:**

Naam: \_\_\_\_\_

Adres: \_\_\_\_\_ Plaats: \_\_\_\_\_

Postcode: \_\_\_\_\_

Contactpersoon: \_\_\_\_\_ Tel. contactpersoon: \_\_\_\_\_

Datum: \_\_\_\_\_ Opdracht nr.: \_\_\_\_\_

Paraaf: \_\_\_\_\_ Afleverdatum: \_\_\_\_\_



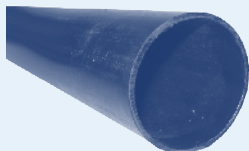
## 07.05 Geberit PE Afvoersysteem

### Geberit PE afvoerbuis

- Installatie instructies van het PE Afvoerprogramma zijn op te vragen bij onze verkoopmedewerkers.

|                             | Buitendiameter<br>x wanddikte in mm | Artikelnr. |
|-----------------------------|-------------------------------------|------------|
| <b>PE Afvoerbuis</b>        | 32 x 3,0                            | 379000     |
| - met KOMO-Keur             | 40 x 3,0                            | 360000     |
| - volgens NEN 7008 en 7018  | 50 x 3,0                            | 361000     |
| - standaard lengte: 5 meter | 56 x 3,0                            | 363000     |
|                             | 63 x 3,0                            | 364000     |
|                             | 75 x 3,0                            | 365000     |
|                             | 90 x 3,5                            | 366000     |
|                             | 110 x 4,3                           | 367000     |
|                             | 125 x 4,9                           | 368000     |
|                             | 160 x 6,2                           | 369000     |
|                             | 200 x 6,2                           | 370000     |
|                             | 250 x 7,8                           | 371000     |
|                             | 315 x 9,8                           | 372000     |

Artikelgroep: 07.05.05



07

### Geberit PE afvoerhulpstukken


|                         | Afmeting in mm | Artikelnr. |
|-------------------------|----------------|------------|
| <b>PE Elektrolasmof</b> | 40             | 360771     |
|                         | 50             | 361771     |
|                         | 56             | 363771     |
|                         | 63             | 364771     |
|                         | 75             | 365771     |
|                         | 90             | 366771     |
|                         | 110            | 367771     |
|                         | 125            | 368771     |
|                         | 160            | 369771     |
|                         | 200            | 370775     |
|                         | 250            | 371775     |
|                         | 315            | 372775     |

Artikelgroep: 07.05.10




Voor lasspiegels en elektrolasmachines verwijzen wij u naar Groep 21 'Machines en gereedschappen'.

## Geberit PE afvoerhulpstukken

|   | Afmeting in mm | Artikelnr. |
|---|----------------|------------|
| <b>PE Verloopstuk</b><br>- centrisch<br> | 40 x 32        | 360557     |
|   | 50 x 32        | 361557     |
|   | 50 x 40        | 361559     |
|   | 56 x 40        | 363559     |
|   | 56 x 50        | 363560     |
|   | 63 x 40        | 364559     |
|   | 63 x 50        | 364560     |
|   | 63 x 56        | 364565     |
|   | 75 x 40        | 365559     |
|   | 75 x 50        | 365560     |
|   | 75 x 56        | 365565     |
|   | 75 x 63        | 365570     |
|   | 90 x 40        | 366559     |
|   | 90 x 50        | 366560     |
|   | 90 x 56        | 366565     |
|   | 90 x 63        | 366570     |
|   | 90 x 75        | 366575     |
|   | 110 x 40       | 367559     |
|   | 110 x 50       | 367560     |
|   | 110 x 56       | 367565     |
|   | 110 x 63       | 367570     |
|   | 110 x 75       | 367575     |
|   | 110 x 90       | 367580     |
|   | 125 x 63       | 368570     |
|   | 125 x 75       | 368575     |
|   | 125 x 90       | 368580     |
|   | 125 x 110      | 368585     |
|   | 160 x 110      | 369535     |

Artikelgroep: 07.05.10

|   | Afmeting in mm | Artikelnr. |
|---|----------------|------------|
| <b>PE Verloopstuk</b><br>- excentrisch<br>- lang model<br> | 125 x 110      | 368584     |
|   | 160 x 110      | 369584     |
|   | 160 x 125      | 369587     |
|   | 200 x 110      | 370584     |
|   | 200 x 125      | 370587     |
|   | 200 x 160      | 370594     |
|   | 250 x 200      | 371596     |
|   | 315 x 200      | 372596     |
|   | 315 x 250      | 372598     |

Artikelgroep: 07.05.10

|   | Afmeting in mm | Artikelnr. |
|---|----------------|------------|
| <b>PE Verloopstuk</b><br>- excentrisch<br> | 50 x 40        | 361558     |
|   | 56 x 40        | 363558     |
|   | 56 x 50        | 363561     |
|   | 63 x 50        | 364561     |
|   | 63 x 56        | 364566     |
|   | 75 x 40        | 365558     |
|   | 75 x 50        | 365561     |
|   | 75 x 56        | 365566     |
|   | 75 x 63        | 365571     |
|   | 90 x 50        | 366561     |
|   | 90 x 56        | 366566     |
|   | 90 x 63        | 366571     |
|   | 90 x 75        | 366576     |
|   | 110 x 40       | 367558     |
|   | 110 x 50       | 367561     |
|   | 110 x 56       | 367566     |
|   | 110 x 63       | 367571     |
|   | 110 x 75       | 367576     |
|   | 110 x 90       | 367581     |
|   | 125 x 50       | 368561     |
|   | 125 x 56       | 368566     |
|   | 125 x 63       | 368571     |
|   | 125 x 75       | 368576     |
| 125 x 90  | 368581         |            |
| 125 x 110   | 368586         |            |
| 160 x 110   | 369586         |            |
| 160 x 125   | 369588         |            |

Artikelgroep: 07.05.10

|   | Afmeting in mm | Artikelnr. |
|---|----------------|------------|
| <b>PE Expansiemof</b><br> | 40             | 360700     |
|   | 50             | 361700     |
|   | 56             | 363700     |
|   | 63             | 364700     |
|   | 75             | 365700     |
|   | 90             | 366700     |
|   | 110            | 367700     |
|   | 125            | 368700     |
|   | 160            | 369700     |
|   | 200            | 370700     |


Artikelgroep: 07.05.10

# 07.05 Geberit PE Afvoersysteem


## Geberit PE afvoerhulpstukken


|   | Afmeting in mm         | Artikelnr. |
|---|------------------------|------------|
|  | 50                     | 361088     |
|   | 56                     | 363088     |
|   | 63                     | 364088     |
|   | 75                     | 365088     |
|   | 90                     | 366088     |
|   | 110                    | 367088     |
|   | 125                    | 368088     |
|   | 160                    | 369088     |
|   | 200*                   | 370055     |
|   | 250*                   | 371055     |
|   | Artikelgroep: 07.05.10 |            |

\* Gelaste uitvoering


|   | Afmeting in mm | Artikelnr. |
|---|----------------|------------|
|  | 40             | 360045     |
|   | 50             | 361045     |
|   | 56             | 363045     |
|   | 63             | 364045     |
|   | 75             | 365045     |
|   | 90             | 366045     |
|   | 110            | 367045     |
|   | 125            | 368045     |
|   | 160            | 369045     |
|   | 200            | 370045     |
|   | 250            | 371045     |
| Artikelgroep: 07.05.10  |                |            |

|   | Afmeting in mm | Artikelnr. |
|---|----------------|------------|
|  | 32             | 379055     |
|   | 40             | 360055     |
|   | 50             | 361055     |
|   | 56             | 363055     |
|   | 63             | 364055     |
|   | 75             | 365055     |
|   | 90             | 366055     |
|   | 110            | 367055     |
|   | 125            | 368055     |
| 160   | 369055         |            |
| Artikelgroep: 07.05.10  |                |            |

|   | Afmeting in mm | Artikelnr. |
|---|----------------|------------|
|  | 40             | 360779     |
|   | 50             | 361779     |
|   | 56             | 363779     |
|   | 63             | 364779     |
|   | 75             | 365779     |
|   | 90             | 366779     |
|   | 110            | 367779     |
|   | 125            | 368779     |
|   | 160            | 369779     |
| Artikelgroep: 07.05.10  |                |            |

|   | Afmeting in mm  | Artikelnr. |
|---|-----------------|------------|
|  | 40 x 40 x 40    | 360159     |
|   | 50 x 40 x 50    | 361159     |
|   | 50 x 50 x 50    | 361162     |
|   | 63 x 40 x 63    | 364159     |
|   | 63 x 50 x 63    | 364162     |
|   | 63 x 63 x 63    | 364170     |
|   | 75 x 40 x 75    | 365159     |
|   | 75 x 50 x 75    | 365162     |
|   | 75 x 63 x 75    | 365170     |
|   | 75 x 75 x 75    | 365175     |
|   | 90 x 50 x 90    | 366162     |
|   | 90 x 63 x 90    | 366170     |
|   | 90 x 75 x 90    | 366175     |
|   | 90 x 90 x 90    | 366180     |
|   | 110 x 40 x 110  | 367159     |
|   | 110 x 50 x 110  | 367162     |
|   | 110 x 63 x 110  | 367170     |
|   | 110 x 75 x 110  | 367175     |
|   | 110 x 90 x 110  | 367180     |
|   | 110 x 110 x 110 | 367185     |
|   | 125 x 50 x 125  | 368162     |
|   | 125 x 63 x 125  | 368170     |
|   | 125 x 75 x 125  | 368175     |
|   | 125 x 90 x 125  | 368180     |
|   | 125 x 110 x 125 | 368185     |
|   | 125 x 125 x 125 | 368189     |
|   | 160 x 75 x 160  | 369175     |
| 160 x 110 x 160   | 369185          |            |
| 160 x 125 x 160   | 369189          |            |
| 160 x 160 x 160   | 369195          |            |
| 200 x 110 x 200   | 370185          |            |
| 200 x 160 x 200   | 370195          |            |
| 200 x 200 x 200   | 370196          |            |
| 250 x 110 x 250   | 371185          |            |
| 250 x 160 x 250   | 371195          |            |
| 250 x 250 x 250   | 371197          |            |
| 315 x 110 x 315   | 372185          |            |
| 315 x 160 x 315   | 372195          |            |
| Artikelgroep: 07.05.10  |                 |            |

## Geberit PE afvoerhulpstukken

|   | Afmeting in mm  | Artikelnr. |
|---|-----------------|------------|
| <b>PE T-stuk 45°</b><br> | 40 x 40 x 40    | 360109     |
|   | 50 x 40 x 50    | 361109     |
|   | 50 x 50 x 50    | 361112     |
|   | 56 x 50 x 56    | 363112     |
|   | 56 x 56 x 56    | 363115     |
|   | 63 x 40 x 63    | 364109     |
|   | 63 x 50 x 63    | 364112     |
|   | 63 x 56 x 63    | 364115     |
|   | 63 x 63 x 63    | 364120     |
|   | 75 x 40 x 75    | 365109     |
|   | 75 x 50 x 75    | 365112     |
|   | 75 x 56 x 75    | 365115     |
|   | 75 x 63 x 75    | 365120     |
|   | 75 x 75 x 75    | 365125     |
|   | 90 x 50 x 90    | 366112     |
|   | 90 x 56 x 90    | 366115     |
|   | 90 x 63 x 90    | 366120     |
|   | 90 x 75 x 90    | 366125     |
|   | 90 x 90 x 90    | 366130     |
|   | 110 x 50 x 110  | 367112     |
|   | 110 x 56 x 110  | 367115     |
|   | 110 x 63 x 110  | 367120     |
|   | 110 x 75 x 110  | 367125     |
|   | 110 x 90 x 110  | 367130     |
|   | 110 x 110 x 110 | 367135     |
|   | 125 x 63 x 125  | 368120     |
|   | 125 x 75 x 125  | 368125     |
|   | 125 x 90 x 125  | 368130     |
|   | 125 x 110 x 125 | 368135     |
|   | 125 x 125 x 125 | 368139     |
|   | 160 x 75 x 160  | 369125     |
|   | 160 x 90 x 160  | 369130     |
|   | 160 x 110 x 160 | 369135     |
|   | 160 x 125 x 160 | 369139     |
|   | 160 x 160 x 160 | 369145     |
| 200 x 110 x 200   | 370135          |            |
| 200 x 125 x 200   | 370139          |            |
| 200 x 160 x 200   | 370145          |            |
| 200 x 200 x 200   | 370146          |            |
| 250 x 160 x 250   | 371145          |            |
| 250 x 200 x 250   | 371146          |            |
| 250 x 250 x 250   | 371147          |            |
| 315 x 125 x 315   | 372139          |            |
| 315 x 160 x 315   | 372145          |            |
| 315 x 200 x 315   | 372146          |            |
| 315 x 250 x 315   | 372147          |            |
| 315 x 315 x 315   | 372148          |            |


Artikelgroep: 07.05.10

|  | Afmeting in mm | Artikelnr. |
|--|----------------|------------|
| <b>PE Ontstoppingsstuk 90°</b><br>- met schroefdeksel<br> | 63 x 63        | 364451     |
|  | 75 x 75        | 365451     |
|  | 90 x 90        | 366451     |
|  | 110 x 110      | 367451     |
|  | 125 x 110      | 368451     |
|  | 160 x 110      | 369451     |


Artikelgroep: 07.05.10

|  | Afmeting in mm | Artikelnr. |
|--|----------------|------------|
| <b>PE Ontstoppingsstuk 45°</b><br>- met schroefdeksel<br> | 110 x 110      | 367453     |
|  | 125 x 110      | 368453     |
|  | 160 x 110      | 369453     |

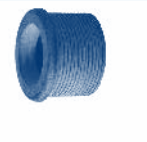
Artikelgroep: 07.05.10

|   | Afmeting in mm | Artikelnr. |
|---|----------------|------------|
| <b>PE Schroefkoppeling</b><br>- compleet<br> | 32             | 379740     |
|   | 40             | 360740     |
|   | 50             | 361740     |
|   | 56             | 363740     |
|   | 63             | 364740     |
|   | 75             | 365740     |
|   | 90             | 366740     |
| 110   | 367740         |            |


Artikelgroep: 07.05.10

|   | Afmeting in mm | Artikelnr. |
|---|----------------|------------|
| <b>PE Schroefkap</b><br>- compleet<br> | 40             | 360750     |
|   | 50             | 361750     |
|   | 56             | 363750     |
|   | 63             | 364750     |
|   | 75             | 365750     |
|   | 90             | 366750     |
| 110   | 367750         |            |

Artikelgroep: 07.05.10

|  | Afmeting in mm | Artikelnr. |
|--|----------------|------------|
| <b>Gummilippenring</b><br>- voor buis in buis verbinding<br> | 50 x 32        | 152682     |
|  | 50 x 40        | 152796     |
|  | 56 x 32        | 152689     |
|  | 56 x 40        | 152690     |
|  | 63 x 32        | 152691     |
|  | 63 x 40        | 152692     |
|  | 63 x 50        | 152693     |
|  | 75 x 50        | 152694     |

Artikelgroep: 07.05.10

|  | Afmeting in mm | Artikelnr. |
|--|----------------|------------|
| <b>Gummilippenring</b><br>- voor sifonaansluitmof<br> | 46 x 32        | 152495     |
|  | 46 x 40        | 152496     |
|  | 58 x 32        | 153564     |
|  | 58 x 40        | 153565     |
|  | 58 x 50        | 153566     |

Artikelgroep: 07.05.10


# 07.05 Geberit PE Afvoersysteem

## Geberit PE afvoerhulpstukken

|                     | Afmeting in mm | Artikelnr.             |
|---------------------|----------------|------------------------|
| <b>RVS Steuning</b> | 50             | 359454                 |
| - te gebruiken voor | 56             | 359455                 |
| overgangs-          | 63             | 359456                 |
| koppelingen         | 75             | 359457                 |
| - voor PE buis en   | 90             | 359458                 |
| hulpstukken         |                | Artikelgroep: 07.05.10 |




|                        | Afmeting in mm | Artikelnr.             |
|------------------------|----------------|------------------------|
| <b>PE Aansluitstuk</b> | 40 x 50        | 152153                 |
| - met krimpmof en      | 40 x 60        | 152154                 |
| gummi dichting         | 40 x 70        | 152155                 |
|                        | 40 x 80        | 152156                 |
|                        | 50 x 60        | 152651                 |
|                        | 50 x 70        | 152197                 |
|                        | 50 x 80        | 152198                 |
|                        | 50 x 90        | 152652                 |
|                        | 50 x 100       | 152653                 |
|                        | 63 x 73        | 152657                 |
|                        | 63 x 80        | 152658                 |
|                        | 63 x 90        | 152659                 |
|                        | 75 x 80        | 152152                 |
|                        | 75 x 90        | 152151                 |
|                        | 75 x 100       | 152661                 |
|                        | 90 x 110       | 366550                 |
|                        | 110 x 125      | 367551                 |
|                        | 110 x 140      | 367550                 |
|                        | 125 x 150      | 368550                 |
|                        | 160 x 195      | 369550                 |
|                        | 200 x 230      | 370550                 |
|                        |                | Artikelgroep: 07.05.10 |




|                        | Afmeting    | Artikelnr.             |
|------------------------|-------------|------------------------|
| <b>PE Aansluitstuk</b> | 40 x 1 1/4" | 152107                 |
| - met wartel           | 40 x 1 1/2" | 152108                 |
| en pakking             | 40 x 2"     | 152109                 |
|                        | 50 x 1 1/4" | 152115                 |
|                        | 50 x 1 1/2" | 152113                 |
|                        | 50 x 2"     | 152114                 |
|                        |             | Artikelgroep: 07.05.10 |




|                      | Afmeting in mm | Artikelnr.             |
|----------------------|----------------|------------------------|
| <b>PE Eindlaskap</b> | 40             | 360812                 |
|                      | 50             | 361812                 |
|                      | 56             | 363812                 |
|                      | 63             | 364812                 |
|                      | 75             | 365812                 |
|                      | 90             | 366812                 |
|                      | 110            | 367812                 |
|                      | 125            | 368812                 |
|                      | 160            | 369812                 |
|                      |                | Artikelgroep: 07.05.10 |




|                      | Afmeting    | Artikelnr.             |
|----------------------|-------------|------------------------|
| <b>PE Schroefbus</b> | 40 x 1/2"   | 360719                 |
| - versterkte         | 40 x 3/4"   | 360720                 |
| uitvoering           | 40 x 1"     | 360721                 |
|                      | 50 x 1/2"   | 361719                 |
|                      | 50 x 3/4"   | 361720                 |
|                      | 50 x 1"     | 361721                 |
|                      | 50 x 1 1/4" | 361722                 |
|                      | 50 x 1 1/2" | 361723                 |
|                      | 56 x 2"     | 363724                 |
|                      | 63 x 2"     | 364724                 |
|                      | 75 x 2 1/2" | 365725                 |
|                      |             | Artikelgroep: 07.05.10 |




|                    | Afmeting    | Artikelnr.             |
|--------------------|-------------|------------------------|
| <b>PE Puntstuk</b> | 50 x 1 1/4" | 361726                 |
| - versterkte       | 50 x 1 1/2" | 361727                 |
| uitvoering         | 56 x 2"     | 363728                 |
|                    | 63 x 2"     | 364728                 |
|                    | 75 x 2 1/2" | 365729                 |
|                    |             | Artikelgroep: 07.05.10 |



|                       | Afmeting in mm | Artikelnr.             |
|-----------------------|----------------|------------------------|
| <b>PE Sifon</b>       | 40 x 40        | 152036                 |
| - inlaat verticaal    | 40 x 50        | 152033                 |
| - uitlaat horizontaal | 50 x 50        | 152039                 |
|                       |                | Artikelgroep: 07.05.10 |



|                  | Afmeting in mm | Artikelnr.             |
|------------------|----------------|------------------------|
| <b>PE Sifon</b>  | 40 x 40        | 152035                 |
| - in- en uitlaat | 40 x 50        | 152032                 |
| verticaal        | 50 x 50        | 152038                 |
|                  |                | Artikelgroep: 07.05.10 |




|                  | Afmeting in mm | Artikelnr.             |
|------------------|----------------|------------------------|
| <b>PE Sifon</b>  | 40 x 40        | 152037                 |
| - in- en uitlaat | 40 x 50        | 152034                 |
| horizontaal      | 50 x 50        | 152040                 |
|                  |                | Artikelgroep: 07.05.10 |



## Geberit PE afvoerhulpstukken


|  | Afmeting in mm | Artikelnr.             |
|--|----------------|------------------------|
| <b>PE Sifon-aansluitbocht</b><br>- 90°<br>- met spiedeksel | 40 x 46        | 360061                 |
|  | 50 x 46        | 361061                 |
|  | 50 x 58        | 361065                 |
|  |                | Artikelgroep: 07.05.10 |



|   | Afmeting in mm | Artikelnr.             |
|---|----------------|------------------------|
| <b>Beugel</b><br>- gegalvaniseerd<br>- met moer M10<br>- zware uitvoering | 40             | 360843                 |
|   | 50             | 361843                 |
|   | 56             | 363843                 |
|   | 63             | 364843                 |
|   | 75             | 365843                 |
|   | 90             | 366843                 |
|   | 110            | 367843                 |
|   | 125            | 368843                 |
|   | 160            | 369843                 |
|   |                | Artikelgroep: 07.05.10 |



|  | Afmeting in mm | Artikelnr.             |
|--|----------------|------------------------|
| <b>Beugel</b><br>- gegalvaniseerd<br>- met moer 1/2" | 40             | 360841                 |
|  | 50             | 361841                 |
|  | 56             | 363841                 |
|  | 63             | 364841                 |
|  | 75             | 365841                 |
|  | 90             | 366841                 |
|  | 110            | 367841                 |
|  | 125            | 368841                 |
|  |                | Artikelgroep: 07.05.10 |



|  | Afmeting in mm | Artikelnr.             |
|--|----------------|------------------------|
| <b>Elektrolasband voor vastpunt-constructies</b> | 50             | 361776                 |
|  | 56             | 363776                 |
|  | 63             | 364776                 |
|  | 75             | 365776                 |
|  | 90             | 366776                 |
|  | 110            | 367776                 |
|  | 125            | 368776                 |
|  | 160            | 369776                 |
|  |                | Artikelgroep: 07.05.10 |



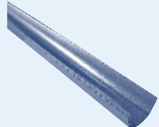
|   | Afmeting | Artikelnr.             |
|---|----------|------------------------|
| <b>Bevestigingsschijf</b><br>- met moer | M10      | 362837                 |
|   |          | Artikelgroep: 07.05.10 |



|  | Afmeting | Artikelnr.             |
|--|----------|------------------------|
| <b>Bevestigingsplaat</b><br>- met aangelaste draadmoer | 1/2"     | 362826                 |
|  |          | Artikelgroep: 07.05.10 |



|  | Afmeting in mm | Artikelnr.             |
|--|----------------|------------------------|
| <b>Halfschalen</b><br>- gegalvaniseerd<br>- lengte: standaard op 3 meter | 16             | 1520016                |
|  | 20             | 1520020                |
|  | 25             | 1520025                |
|  | 32             | 1520032                |
|  | 40             | 36085025               |
|  | 50             | 36185025               |
|  | 56             | 36385025               |
|  | 63             | 36485025               |
|  | 75             | 36585025               |
|  | 90             | 36685025               |
|  | 110            | 36785025               |
|  | 125            | 36885025               |
|  | 160            | 36985025               |
|  | 200            | 37085025               |
|  |                | Artikelgroep: 07.05.10 |



A large light blue rectangular area with horizontal ruling lines, intended for taking notes. The lines are evenly spaced and extend across the width of the page.

# Productgroep 08

PE Drukleidingen > PVC Drukleidingen > PP Drukleidingen  
> Afstandbediende afsluiters > C-PVC Programma >  
Blue-system programma > Binnen- en buitenriolering  
> Kabelbescherming en telecom > Milieu programma  
> Tanks > Folie en geotextielen > Halffabrikaten >  
RVS Programma > Malleable programma > Sanitair  
en verwarming > Metalen appendages en fittingen >  
Slangen en koppelingen > Pompen, filters en kabel  
> Lijm, reiniger en toebehoren > Bevestigingsmaterialen >  
Machines en gereedschappen

>> Kabelbescherming en telecom

# Milder

— VEELZIJDIG IN LEIDINGSYSTEMEN —



# 08.01 Kabelbescherming

## PE Kabelbescherming

- Voor de diverse buizen in deze productgroep geldt dat andere kleuren, diameters of rollengten op aanvraag zijn. Neem hiervoor contact op met onze afdeling verkoop.

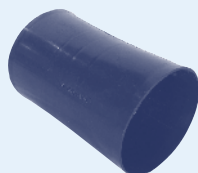
|  | Afmeting in mm | (Rol)lengte in meter | Artikelnr. |
|--|----------------|----------------------|------------|
| <b>9901</b><br><b>PE Flexibele kabelbeschermingsbuis</b><br>- kleur: rood voor elektra, uit voorraad leverbaar<br>- kleur: groen voor CAI, op aanvraag leverbaar<br>- geribde buitenzijde<br>- gladde binnenzijde<br>- slagvast<br>- inclusief trekkoord | 40             | 25                   | 9901040025 |
|  | 40             | 50                   | 9901040050 |
|  | 50             | 50                   | 9901050050 |
|  | 63             | 50                   | 9901063050 |
|  | 75             | 50                   | 9901075050 |
|  | 90             | 50                   | 9901090050 |
|  | 110            | 6                    | 9901110006 |
|  | 110            | 50                   | 9901110050 |
|  | 125            | 6                    | 9901125006 |
|  | 125            | 50                   | 9901125050 |
|  | 160            | 6                    | 9901160006 |
|  | 160            | 25                   | 9901160025 |
|  | 200            | 25                   | 9901200025 |

Artikelgroep: 08.01.05



|  | Afmeting in mm | Artikelnr. |
|--|----------------|------------|
| <b>9902</b><br><b>PE Klikmof</b><br>- voor artikelnr. 9901, PE Flexibele kabelbeschermingsbuis | 40             | 9902040    |
|  | 50             | 9902050    |
|  | 63             | 9902063    |
|  | 75             | 9902075    |
|  | 90             | 9902090    |
|  | 110            | 9902110    |
|  | 125            | 9902125    |
|  | 160            | 9902160    |
|  | 200            | 9902200    |

Artikelgroep: 08.01.05



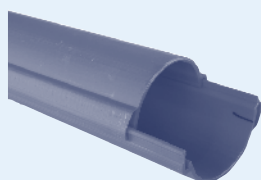
|   | Afmeting in mm | Artikelnr. |
|---|----------------|------------|
| <b>9903</b><br><b>Afdichtingsring</b><br>- voor artikelnr. 9902, PE Klikmof | 75             | 9903075    |
|   | 90             | 9903090    |
|   | 110            | 9903110    |
|   | 125            | 9903125    |
|   | 160            | 9903160    |

Artikelgroep: 08.01.05



|  | Afmeting in mm | Artikelnr. |
|--|----------------|------------|
| <b>9907</b><br><b>PE Deelbare kabelbeschermingsbuis</b><br>- lengte: standaard op 3 meter<br>- kleur: rood | 110            | 9907110    |
|  | 160            | 9907160    |

Artikelgroep: 08.01.05



|   | Afmeting in mm | Rollengte in meter | Kleur  | Artikelnr. |
|---|----------------|--------------------|--------|------------|
| <b>9908</b><br><b>PE Gegroefde buis</b><br>- voor glasvezel | 32             | 300                | rood   | 9908032RD  |
|   | 32             | 300                | groen  | 9908032GN  |
|   | 40             | 250                | rood   | 9908040RD  |
|   | 40             | 250                | groen  | 9908040GN  |
|   | 40             | 250                | blauw  | 9908040BL  |
|   | 40             | 250                | oranje | 9908040OR  |
|   | 50             | 250                | groen  | 9908050GN  |
|   | 50             | 250                | blauw  | 9908050BL  |

Andere rollengten/haspels op aanvraag leverbaar.

Artikelgroep: 08.01.05



## PVC Kabelbescherming

### 9905

#### PVC Kabelbeschermingsbuis

- lengte: 5 meter met lijmmof
- SN4



| Afmeting in mm | Kleur | Artikelnr. |
|----------------|-------|------------|
| 75             | rood  | 9905075RD  |
| 75             | groen | 9905075GN  |
| 110            | blauw | 9905110BW  |
| 110            | rood  | 9905110RD  |
| 110            | groen | 9905110GN  |
| 125            | rood  | 9905125RD  |
| 125            | groen | 9905125GN  |
| 160            | rood  | 9905160RD  |
| 160            | groen | 9905160GN  |
| 200            | rood  | 9905200RD  |
| 200            | groen | 9905200GN  |

Artikelgroep: 08.01.10

08

### 9906

#### PVC Kabelbeschermingsbuis

- lengte: 5 meter met lijmmof
- SN8
- kleur blauw op aanvraag leverbaar



| Afmeting in mm | Kleur | Artikelnr. |
|----------------|-------|------------|
| 75             | rood  | 9906075RD  |
| 75             | groen | 9906075GN  |
| 110            | rood  | 9906110RD  |
| 110            | groen | 9906110GN  |
| 125            | rood  | 9906125RD  |
| 125            | groen | 9906125GN  |
| 160            | rood  | 9906160RD  |
| 160            | groen | 9906160GN  |
| 200            | rood  | 9906200RD  |
| 200            | groen | 9906200GN  |

Artikelgroep: 08.01.10

### 9899 - 9900

#### PVC Elektrabuis

- KEMA-keur (waar van toepassing)
- lengte: standaard op 4 meter



| Afmeting | Artikelnr. crème | Artikelnr. slagvast grijs |
|----------|------------------|---------------------------|
| 5/8"     | 9899058          | 9900058                   |
| 3/4"     | 9899034          | 9900034                   |
| 1"       | 9899100          | 9900100                   |
| 1 1/4"   | 9899114          | 9900114                   |
| 1 1/2"   | 9899112          | 9900112                   |
| 2"       | 9899200          | 9900200                   |

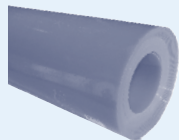
Artikelgroep: 08.01.10

# 08.01 Kabelbescherming

## Toebehoren voor kabelbescherming

|  | Afmeting in mm | Kleur | Rollengte in meter | Artikelnr. |
|--|----------------|-------|--------------------|------------|
| <b>9911</b><br><b>Kabelafdekband</b><br>- voor bescherming van ondergronds gelegde kabels en leidingen | 100 x 2        | groen | 50                 | 9911100GR  |
|  | 120 x 2        | groen | 50                 | 9911120GR  |
|  | 150 x 2        | groen | 50                 | 9911150GR  |
|  | 150 x 2,5      | rood  | 50                 | 9911150RD  |
|  | 200 x 2        | groen | 40                 | 9911200GR  |
|  | 300 x 2        | groen | 50                 | 9911300GR  |
|  | 300 x 3        | rood  | 30                 | 9911300RD  |
|  | 600 x 2,5      | rood  | 15                 | 9911600RD  |

Artikelgroep: 08.01.15



|  | Kabeldiameter | Kleur     | Artikelnr. |
|--|---------------|-----------|------------|
| <b>9912</b><br><b>Kabellabel</b><br>- voor het merken van ondergrondse kabels en leidingen | tot 60mm      | blauw     | 9912060BW  |
|  | tot 60mm      | geel      | 9912060GL  |
|  | tot 60mm      | groen     | 9912060GN  |
|  | tot 60mm      | grijs     | 9912060GS  |
|  | tot 60mm      | oranje    | 9912060OE  |
|  | tot 60mm      | rood      | 9912060RD  |
|  | tot 60mm      | wit       | 9912060WT  |
|  | tot 75mm      | blauw     | 9912075BW  |
|  | tot 75mm      | geel      | 9912075GL  |
|  | tot 75mm      | groen     | 9912075GN  |
|  | tot 75mm      | grijs     | 9912075GS  |
|  | tot 75mm      | rood      | 9912075RD  |
|  | tot 75mm      | wit       | 9912075WT  |
|  | tot 95mm      | blauw     | 9912095BW  |
|  | tot 95mm      | geel      | 9912095GL  |
|  | tot 95mm      | groen     | 9912095GN  |
|  | tot 95mm      | grijs     | 9912095GS  |
|  | tot 95mm      | rood      | 9912095RD  |
|  | tot 95mm      | wit       | 9912095WT  |
|  | tot 140mm     | blauw     | 9912140BW  |
|  | tot 140mm     | geel      | 9912140GL  |
|  | tot 140mm     | groen     | 9912140GN  |
|  | tot 140mm     | grijs     | 9912140GS  |
| tot 140mm  | rood          | 9912140RD |            |
| tot 140mm  | wit           | 9912140WT |            |

Artikelgroep: 08.01.15



|  | Opschrift             | Kleur | Artikelnr. |
|--|-----------------------|-------|------------|
| <b>9913</b><br><b>Waarschuingslint</b><br>- dikte: 0,15mm<br>- breedte: 40mm<br>- rollengte: 250 meter | Elektra               | rood  | 99139      |
|  | Gas                   | geel  | 99131      |
|  | Glasvezelkabel        | groen | 99135      |
|  | Rioolwaterpersleiding | groen | 99133      |
|  | Waterleiding          | blauw | 99132      |
|  | Stadsverwarming       | groen | 99136      |
|  | Aardwarmte            | paars | 99317      |

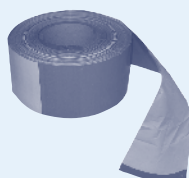
Artikelgroep: 08.01.15



Andere opschriften op aanvraag leverbaar.

|  | Artikelnr. |
|--|------------|
| <b>9914</b><br><b>Afzetlint</b><br>- kleuren: rood/wit<br>- breedte: 80mm<br>- rollengte: 500 meter<br>- in kartonnen afwikkeldoos | 9914       |

Artikelgroep: 08.01.15



Telecom

| Artikelnr.  |                                |
|---|--------------------------------|
| <b>9545</b><br><b>Handhole HH1 (Controleput)</b><br>- rechthoekig model<br>- voor telecomsystemen<br>- materiaal: polyethyleen<br>- afsluitbaar met een sleutel,<br>artikelnr. 95451<br>- model beschermd | 9545<br>Artikelgroep: 08.02.05 |



| Afmeting in mm   | Artikelnr.                          |
|--|-------------------------------------|
| <b>95580</b><br><b>PE Putdeksel</b><br>- voor PE<br>Kabeltrekput,<br>artikelnr. 9558 | 955806001<br>Artikelgroep: 08.02.05 |

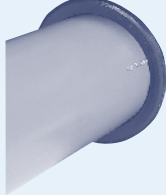


| Artikelnr.   |                                |
|--|--------------------------------|
| <b>9546</b><br><b>Handhole HH2 (Controleput)</b><br>- rond model<br>- voor telecomsystemen<br>- materiaal: polyethyleen<br>- model beschermd | 9546<br>Artikelgroep: 08.02.05 |



| Afmeting in mm  | Artikelnr.   |
|---|--|
| <b>95062</b><br><b>Doorvoermanchet</b><br>- materiaal: rubber<br>- voor o.a.<br>doorvoeringen | 95062025<br>95062032<br>95062040<br>95062050<br>95062063<br>95062075<br>95062090<br>95062110<br>95062125<br>95062140<br>95062160<br>95062180<br>95062200<br>95062225<br>95062250<br>95062315<br>95062400 |

Artikelgroep: 09.03.05



| Artikelnr.  |                                 |
|---|---------------------------------|
| <b>95451</b><br><b>Sleutel</b><br>- voor Handhole HH1,<br>artikelnr. 9545 | 95451<br>Artikelgroep: 08.02.05 |



| Afmeting in mm   | Voor manchet in mm   | Artikelnr.   |
|--|--|--|
| <b>95061</b><br><b>Gatzaag</b><br>- voor het zagen van<br>gaten voor o.a.<br>doorvoeringen | 70<br>83<br>98<br>124<br>138<br>155<br>175<br>195<br>215<br>240<br>265<br>330<br>415 | 63<br>75<br>90<br>110<br>125<br>140<br>160<br>180<br>200<br>225<br>250<br>315<br>400 |

Artikelgroep: 09.03.05



|                                       | Afmeting in mm | Hoogte in mm | Artikelnr.  |
|---------------------------------------|----------------|--------------|-------------|
| <b>9558</b><br><b>PE Kabeltrekput</b> | 625            | 800          | 95580600080 |
|                                       | 1000           | 700          | 95581000070 |
|                                       | 1000           | 1100         | 95581000110 |

Artikelgroep: 08.02.05



08

# 08.02 Telecom

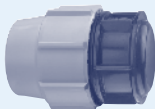
## Toebehoren voor telecom

08

|                  | Afmeting in mm         | Artikelnr. |
|------------------|------------------------|------------|
| <b>7010</b>      | 16                     | 7010016    |
| Rechte koppeling | 20                     | 7010020    |
|                  | 25                     | 7010025    |
|                  | 32                     | 7010032    |
|                  | 40                     | 7010040    |
|                  | 50                     | 7010050    |
|                  | 63                     | 7010063    |
|                  | Artikelgroep: 01.02.05 |            |



|               | Afmeting in mm         | Artikelnr. |  |
|---------------|------------------------|------------|--|
| <b>7120</b>   | 20                     | 7120020    |  |
| Eindkoppeling | 25                     | 7120025    |  |
|               | 32                     | 7120032    |  |
|               | 40                     | 7120040    |  |
|               | 50                     | 7120050    |  |
|               | 63                     | 7120063    |  |
|               | Artikelgroep: 01.02.05 |            |  |

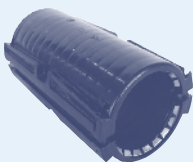


|                                      | Afmeting in mm         | Artikelnr. |
|--------------------------------------|------------------------|------------|
| <b>70101</b>                         | 25                     | 70100251   |
| Rechte koppeling<br>zonder stootrand | 32                     | 70100321   |
|                                      | 40                     | 70100401   |
|                                      | 50                     | 70100501   |
|                                      | Artikelgroep: 01.02.05 |            |




Let op: koppeling **zonder** stootrand.

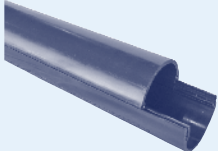
|                    | Afmeting in mm         | Artikelnr. |
|--------------------|------------------------|------------|
| <b>7007</b>        | 32                     | 7007032    |
| Deelbare koppeling | 40                     | 7007040    |
|                    | 50                     | 7007050    |
|                    | Artikelgroep: 08.02.10 |            |



|                  | Afmeting in mm         | Artikelnr. |  |
|------------------|------------------------|------------|--|
| <b>7110</b>      | 20 x 16                | 7110020016 |  |
| Verloopkoppeling | 25 x 16                | 7110025016 |  |
|                  | 25 x 20                | 7110025020 |  |
|                  | 32 x 20                | 7110032020 |  |
|                  | 32 x 25                | 7110032025 |  |
|                  | 40 x 25                | 7110040025 |  |
|                  | 40 x 32                | 7110040032 |  |
|                  | 50 x 25                | 7110050025 |  |
|                  | 50 x 32                | 7110050032 |  |
|                  | 50 x 40                | 7110050040 |  |
|                  | 63 x 25                | 7110063025 |  |
|                  | 63 x 32                | 7110063032 |  |
|                  | 63 x 40                | 7110063040 |  |
|                  | 63 x 50                | 7110063050 |  |
|                  | Artikelgroep: 01.02.05 |            |  |



|                        | Afmeting in mm  | Artikelnr. |
|------------------------|---|------------|
| <b>7009</b>            | 32  | 7009032    |
| Deelbare buis          | 40  | 7009040    |
|                        | 50  | 7009050    |
|                        | - per set<br>- 2 x halfschaal =<br>2 x lengte à 2 meter |            |
| Artikelgroep: 08.02.10 |   |            |

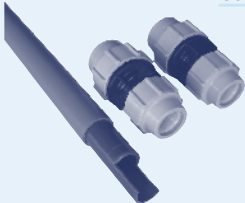


|                                      | Afmeting in mm         | Artikelnr.  |  |
|--------------------------------------|------------------------|-------------|--|
| <b>71101</b>                         | 25 x 16                | 71100250161 |  |
| Verloopkoppeling<br>zonder stootrand | 25 x 20                | 71100250201 |  |
|                                      | 32 x 20                | 71100320201 |  |
|                                      | 32 x 25                | 71100320251 |  |
|                                      | 40 x 25                | 71100400251 |  |
|                                      | 40 x 32                | 71100400321 |  |
|                                      | 50 x 25                | 71100500251 |  |
|                                      | 50 x 32                | 71100500321 |  |
|                                      | 50 x 40                | 71100500401 |  |
|                                      | 63 x 25                | 71100630251 |  |
|                                      | 63 x 32                | 71100630321 |  |
|                                      | 63 x 40                | 71100630401 |  |
|                                      | 63 x 50                | 71100630501 |  |
|                                      | Artikelgroep: 01.02.05 |             |  |



Let op: koppeling **zonder** stootrand.

|                                   | Afmeting in mm         | Artikelnr. |
|-----------------------------------|------------------------|------------|
| <b>7004</b>                       | 16 (25 x 16)           | 7004016    |
| Reparatieset<br>- verpakt per set | 32 (40 x 32)           | 7004032    |
|                                   | 40 (50 x 40)           | 7004040    |
|                                   | 50 (63 x 50)           | 7004050    |
|                                   | 63 (75 x 63)           | 7004063    |
|                                   | Artikelgroep: 08.02.10 |            |



Voor het complete programma Plasson klemfittingen verwijzen wij u naar Groep 1.

# Productgroep 09

PE Drukleidingen > PVC Drukleidingen > PP Drukleidingen  
> Afstandbediende afsluiters > C-PVC Programma >  
Blue-system programma > Binnen- en buitenriolering  
> Kabelbescherming en telecom > Milieu programma  
> Tanks > Folie en geotextielen > Halffabrikaten >  
RVS Programma > Malleable programma > Sanitair  
en verwarming > Metalen appendages en fittingen >  
Slangen en koppelingen > Pompen, filters en kabel  
> Lijm, reiniger en toebehoren > Bevestigingsmaterialen >  
Machines en gereedschappen

>> Milieu programma

# Milder

— VEELZIJDIG IN LEIDINGSYSTEMEN —

# 09.01 PE Inspectie- en pompputten

## PE Inspectie- en pompputten

- Voorzien van een bolle bodem.
- Leverbaar in alle hoogten.
- De gewenste aansluitingen kunnen worden aangebracht op elke gewenste hoogte en richting.
- Om de door u gewenste uitvoering exact weer te geven dient u gebruik te maken van een puttenstaat (zie blz. 183). Deze puttenstaat is ook te downloaden vanaf onze internetsite [www.milder.nl](http://www.milder.nl) of kan via e-mail aan u worden toegezonden.
- Heeft u interesse in PE inspectieputten met vlakke bodem en stroomprofiel, neemt u dan contact op met onze verkoopafdeling.

|                        | Afmeting in mm | Artikelnr. |
|------------------------|----------------|------------|
| <b>9506</b>            | 600            | 95060600   |
| <b>PE Inspectieput</b> | 800            | 95060800   |
| - met bolle bodem      | 1000           | 95061000   |

Artikelgroep: 09.01.05



Putten in de diameters 800 en 1000mm zijn voorzien van een konusdeel waardoor de putten aan de bovenzijde universeel zijn.

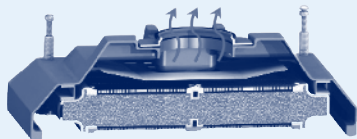
|                   | Afmeting in mm | Artikelnr. |
|-------------------|----------------|------------|
| <b>9556</b>       | 600            | 95560600   |
| <b>PE Pompput</b> | 800            | 95560800   |
|                   | 1000           | 95561000   |

Artikelgroep: 09.01.05



Voor diverse pompen kunnen wij ook inbouwgarituren aanbrengen.

|                                 | Artikelnr.             |
|---------------------------------|------------------------|
| <b>9553</b>                     | 9553                   |
| <b>Aktief koolfilter</b>        | Artikelgroep: 09.01.05 |
| - inclusief actief koolcassette |                        |
| - eenvoudige inbouw             |                        |
| - past op de meeste putdeksels  |                        |
| - functioneert direct           |                        |
| - milieuvriendelijk/recyclebaar |                        |

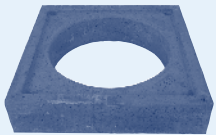


\* Artikelnr. 95531: Aktief kool vervangingscassette.

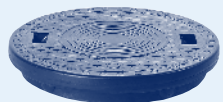
## Putafdekkingen

|                          | Binnendiameter in mm | Voor buisdiameter in mm | Hoogte in mm | Artikelnr. |
|--------------------------|----------------------|-------------------------|--------------|------------|
| <b>9525</b>              | 635                  | 600                     | 200          | 9525       |
| <b>Betonnen stelrand</b> | 635                  | 600                     | 120          | 95250      |
| - voor zwaarverkeers-    | 430                  | 400                     | 200          | 95251      |
| deksel                   | 530                  | 500                     | 200          | 95253      |
| - afmeting lxb 900x900   | 650                  | 630                     | 200          | 95252      |
|                          | 650                  | 630                     | 120          | 95254      |

Artikelgroep: 09.02.05




|                              | Artikelnr.             |
|------------------------------|------------------------|
| <b>9533</b>                  | 9533                   |
| <b>PE Putdeksel</b>          | Artikelgroep: 09.02.05 |
| - voor pomp- of inspectieput |                        |
| - beloopbaar                 |                        |




|                            | Type             | Hoogte in mm | Artikelnr.             |
|----------------------------|------------------|--------------|------------------------|
| <b>9534</b>                | gesloten         | 170          | 9534                   |
| <b>Zwaarverkeersdeksel</b> | open met rooster | 170          | 95341                  |
| - gietijzer/beton          | gesloten         | 240          | 95344                  |
| - zwaar verkeer            |                  |              | Artikelgroep: 09.02.05 |
| - KOMO-keur                |                  |              |                        |
| - klasse D400              |                  |              |                        |



|                         | Lengte in mm | Artikelnr.             |
|-------------------------|--------------|------------------------|
| <b>95343</b>            | 300          | 95343                  |
| <b>Puthaak</b>          | 1000         | 95343100               |
| - voor artikelnr. 9534, |              | Artikelgroep: 09.02.05 |
| Zwaarverkeers-          |              |                        |
| deksel                  |              |                        |



|                         | Afmeting in mm | Artikelnr.             |
|-------------------------|----------------|------------------------|
| <b>9523</b>             | 635            | 9523                   |
| <b>O-ring</b>           | 430            | 95231                  |
| - voor artikelnr. 9525, | 530            | 95232                  |
| Betonnen stelrand       | 650            | 95233                  |
|                         |                | Artikelgroep: 09.02.05 |





# 09.01 PE Inspectie- en pompputten

## Toebehoren voor PE inspectie- en pompputten

|   | Afmeting in mm | Voor manchet in mm | Artikelnr. |
|---|----------------|--------------------|------------|
| <b>95061</b><br><b>Gatzaag</b><br>- voor het boren van gaten voor aansluitingen en doorvoeringen in PE putten | 70             | 63                 | 95061063   |
|   | 83             | 75                 | 95061075   |
|   | 98             | 90                 | 95061090   |
|   | 124            | 110                | 95061110   |
|   | 138            | 125                | 95061125   |
|   | 155            | 140                | 95061140   |
|   | 175            | 160                | 95061160   |
|   | 215            | 200                | 95061200   |
|   | 265            | 250                | 95061250   |
|   | 330            | 315                | 95061315   |
|   | 415            | 400                | 95061400   |



Artikelgroep: 09.03.05

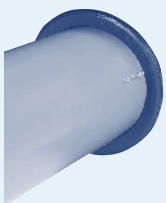
Te gebruiken met gatzaaghouder zie blz. 290, artikelnr. 4717.

|   | Afmeting in mm | Artikelnr. |
|---|----------------|------------|
| <b>950611</b><br><b>Afdichtingsmanchet</b><br>- voor het verhogen van PE inspectie- en pompputten | 600            | 9506110600 |
|   | 800            | 9506110800 |
|   | 1000           | 9506111000 |



Artikelgroep: 09.03.05

|   | Afmeting in mm | Te boren gat | Artikelnr. |
|---|----------------|--------------|------------|
| <b>95062</b><br><b>Doorvoermanchet</b><br>- materiaal: rubber<br>- voor doorvoeringen en aansluitingen in PE putten | 25             | 30           | 95062025   |
|   | 32             | 37           | 95062032   |
|   | 40             | 46           | 95062040   |
|   | 50             | 57           | 95062050   |
|   | 63             | 70           | 95062063   |
|   | 75             | 83           | 95062075   |
|   | 90             | 98           | 95062090   |
|   | 110            | 124          | 95062110   |
|   | 125            | 138          | 95062125   |
|   | 140            | 155          | 95062140   |
|   | 160            | 175          | 95062160   |
|   | 180            | 195          | 95062180   |
|   | 200            | 215          | 95062200   |
|   | 225            | 240          | 95062225   |
|   | 250            | 265          | 95062250   |
|   | 315            | 330          | 95062315   |
|   | 400            | 415          | 95062400   |



Artikelgroep: 09.03.05

## PE Kolken

- Gemaakt van polyethyleen.
- Uit één deel gegoten.
- Modellen beschermd.
- Exclusief afdekking.

|  | Afmeting in mm | Artikelnr.                     |
|--|----------------|--------------------------------|
| <b>9500</b><br><b>PE Milder Milieukolk</b><br>- type M9445<br>- met uitlaat 110mm<br>- hoogte: 1510mm<br>- eenvoudig leeg te zuigen door aangegoten binnenwerk | 315            | 9500<br>Artikelgroep: 09.01.15 |



|  | Afmeting in mm | Artikelnr.                     |
|--|----------------|--------------------------------|
| <b>9531</b><br><b>PE Straat- / trottoirkolk</b><br>- type M94PK<br>- met uitlaat 125mm<br>- hoogte: 730mm<br>- met speciaal aangegoten sifonsysteem<br>- met controle- / ontstopingsmogelijkheid | 315            | 9531<br>Artikelgroep: 09.01.15 |



|   | Afmeting in mm | Artikelnr.                     |
|---|----------------|--------------------------------|
| <b>9541</b><br><b>PE Straat- / trottoirkolk</b><br>- type M94PK<br>- met uitlaat 110mm<br>- speciaal voor het installeren van Plasson klemfittingen<br>- hoogte: 730mm<br>- met speciaal aangegoten sifonsysteem<br>- met controle- / ontstopingsmogelijkheid | 315            | 9541<br>Artikelgroep: 09.01.15 |



|  | Afmeting in mm | Artikelnr.                     |
|--|----------------|--------------------------------|
| <b>9526</b><br><b>PE Controleput (hoog)</b><br>- met aansluiting 160/125mm<br>- uit één deel gegoten<br>- is te gebruiken als controle- en monsternameput in rioleringsystemen | 315            | 9526<br>Artikelgroep: 09.01.15 |



|   | Afmeting in mm | Aansluiting | Artikelnr.             |
|---|----------------|-------------|------------------------|
| <b>9532</b><br><b>PP Controleput PK 315</b><br>- hoogte: 430mm<br>- met stroomprofiel<br>- inclusief kunststof deksel met rubber afdichting<br>- aansluitingen zijn voorzien van manchet<br>- in hoogte verstelbaar d.m.v. artikelnr. 95091, PVC Buis 315 | 315            | 2 x 125     | 9532125                |
|   | 315            | 2 x 160     | 9532160                |
|   | 315            | 2 x 200     | 9532200                |
|   |                |             | Artikelgroep: 09.01.15 |



09

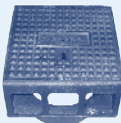
## Kolkafdekkingen

|   | Klasse       | Artikelnr.                                  |
|---|--------------|---|
| <b>9501M</b><br>Gietijzer straatkop   | B125<br>D400 | 9501M125<br>9501M<br>Artikelgroep: 09.02.10 |
|  |              |   |


|   | Klasse | Artikelnr.                      |
|---|--------|---------------------------------|
| <b>95012</b><br>Gietijzer straatkop<br>- NEN-EN 124<br>- type 'VD'<br>- toepassen met artikelnr. 95013, Profielring | D400   | 95012<br>Artikelgroep: 09.02.10 |
|                                    |        |                                 |

|   | Klasse | Artikelnr.                     |
|---|--------|--------------------------------|
| <b>9530</b><br>Gietijzer straatkop<br>- met vergrendeling                           | D400   | 9530<br>Artikelgroep: 09.02.10 |
|  |        |                                |

|   | Type                                      | Artikelnr.                                       |
|---|---|--|
| <b>9551M</b><br>Gietijzer straatkop<br>- gesloten<br>- klasse: B125                 | zonder vergrendeling<br>met vergrendeling | 9551M125<br>9551M125VG<br>Artikelgroep: 09.02.10 |
|  |   |  |

|   | Artikelnr.                     |
|---|--------------------------------|
| <b>9502</b><br>Gietijzer trottoirkop  | 9502<br>Artikelgroep: 09.02.10 |
|  |                                |

|   | Artikelnr.                     |
|---|--------------------------------|
| <b>9507</b><br>Gietijzer trottoirkop<br>- type 'RWS'                                | 9507<br>Artikelgroep: 09.02.10 |
|  |                                |

|   | Artikelnr.                     |
|---|--------------------------------|
| <b>9503</b><br>Gietijzer zeskantegel<br>- voor straatkop                            | 9503<br>Artikelgroep: 09.02.10 |
|  |                                |

|   | Artikelnr.                     |
|---|--------------------------------|
| <b>9508</b><br>Gietijzer vijfkantegel<br>- voor straatkop                           | 9508<br>Artikelgroep: 09.02.10 |
|  |                                |

|  | Artikelnr.                      |
|--|---------------------------------|
| <b>95321</b><br>Deksel PP<br>controleput PK 315<br>- zwart<br>- voor artikelnr. 9532,<br>PP Controleput PK 315 | 95321<br>Artikelgroep: 09.02.10 |
|                            |                                 |

## Toebehoren voor kolken

|   | Artikelnr.                      |
|---|---------------------------------|
| <b>95013</b><br>Profielring<br>- voor artikelnr. 95012<br>Gietijzer straatkop         | 95013<br>Artikelgroep: 09.03.05 |
|  |                                 |

|   | Artikelnr.                     |
|---|--------------------------------|
| <b>9524</b><br>PE Emmer   | 9524<br>Artikelgroep: 09.03.05 |
|  |                                |

|  | Artikelnr.                     |
|--|--------------------------------|
| <b>9513</b><br>Rubber plug voor<br>PE Kolk   | 9513<br>Artikelgroep: 09.03.05 |
|  |                                |

## Peilputten


- Gemaakt van polyethyleen.
- Uit één deel gegoten.
- Exclusief afdekking.


|   |   | Artikelnr.             |
|---|---|------------------------|
| <b>9527</b><br><b>PE Peilput</b><br>- open model<br>- 1½" aansluiting |  | 9527                   |
|   |   | Artikelgroep: 09.01.20 |


|  |   | Artikelnr.             |
|--|---|------------------------|
| <b>952741</b><br><b>PE Peilput</b><br>- gesloten model<br>- 2" aansluiting |  | 952741                 |
|  |   | Artikelgroep: 09.01.20 |

|  |   | Artikelnr.             |
|--|---|------------------------|
| <b>95274</b><br><b>PE Peilput</b><br>- gesloten model<br>- 1½" aansluiting |  | 95274                  |
|  |   | Artikelgroep: 09.01.20 |

## Peilputafdekkingen

|  |   | Artikelnr.             |
|--|---|------------------------|
| <b>95271</b><br><b>Gietijzer peilputdeksel</b><br>- met rand |  | 95271                  |
|  |   | Artikelgroep: 09.02.15 |


|   |   | Artikelnr.             |
|---|---|------------------------|
| <b>95276</b><br><b>Gietijzer rand voor peilputdeksel</b><br>- zonder deksel |  | 95276                  |
|   |   | Artikelgroep: 09.02.15 |

|  |   | Artikelnr.             |
|--|---|------------------------|
| <b>952751</b><br><b>Gietijzer peilputdeksel</b><br>- zonder rand |  | 952751                 |
|  |   | Artikelgroep: 09.02.15 |

## Toebehoren voor peilputten

|  | Hoogte in mm | Artikelnr.             |
|--|--------------|------------------------|
| <b>952780</b><br><b>Peilput</b><br><b>verhogingsstuk</b> | 50           | 95278005               |
|  | 80           | 95278008               |
|  | 100          | 95278010               |
|  | 150          | 95278015               |
|  | 200          | 95278020               |
|  |              | Artikelgroep: 09.03.05 |



|  |   | Artikelnr.             |
|--|---|------------------------|
| <b>95278</b><br><b>Sleutel</b><br>- voor peilputdeksel |  | 95278                  |
|  |   | Artikelgroep: 09.03.05 |

|  |   | Artikelnr.             |
|--|---|------------------------|
| <b>95279</b><br><b>Afdichting</b><br>- tussen peilput-<br>verhogingsstuk<br>en peilputdeksel |  | 95279                  |
|  |   | Artikelgroep: 09.03.05 |

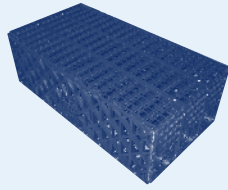
# 09.04 Infiltratieprogramma

## Infiltratie units

### 95901

#### Infiltratie unit

- type A
- zonder geotextielommanteling



Inhoud in liter

Artikelnr.

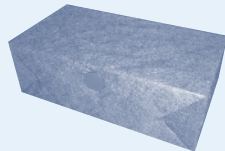
|      |           |
|------|-----------|
| 300  | 959010300 |
| 600  | 959010600 |
| 900  | 959010900 |
| 1200 | 959011200 |

Artikelgroep: 09.04.15

### 95902

#### Infiltratie unit

- type A
- met geotextielommanteling



Inhoud in liter

Artikelnr.

|      |           |
|------|-----------|
| 300  | 959020300 |
| 600  | 959020600 |
| 900  | 959020900 |
| 1200 | 959021200 |

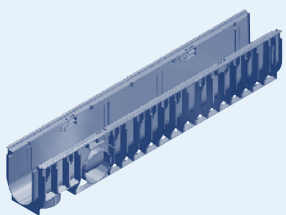
Artikelgroep: 09.04.15

Voor het leveren van PE IT Rioolbuis- en hulpstukken kunt u contact opnemen met onze afdeling verkoop.

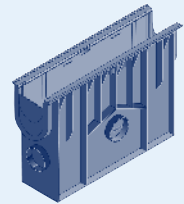
## PE Afvoergoten en toebehoren

- Eenvoudig te installeren.
- 100% recyclebaar PE.
- Breedte: 100mm.

|                      | Lengte in mm | Artikelnr.             |
|----------------------|--------------|------------------------|
| <b>9560</b>          | 500          | 95600500               |
| <b>PE Afvoergoot</b> | 1000         | 95601000               |
|                      |              | Artikelgroep: 09.05.10 |

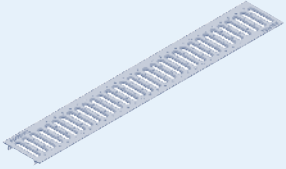


|                                    | Lengte in mm | Artikelnr.             |
|------------------------------------|--------------|------------------------|
| <b>9561</b>                        | 500          | 9561                   |
| <b>PE Zandvanger (aansluitput)</b> |              | Artikelgroep: 09.05.10 |
| - inclusief bezinkbak              |              |                        |
| - lengte: 500mm                    |              |                        |



Bijpassende roosters zijn artikelnr. 9564, 9565 of 9566.

|                     | Lengte in mm | Artikelnr.             |
|---------------------|--------------|------------------------|
| <b>9564</b>         | 500          | 95640500               |
| <b>Sleufrooster</b> | 1000         | 95641000               |
| - verzinkt staal    |              | Artikelgroep: 09.05.10 |



|                                 | Artikelnr.             |
|---------------------------------|------------------------|
| <b>9562</b>                     | 9562                   |
| <b>Eindstuk blind</b>           | Artikelgroep: 09.05.10 |
| - met aansluitmogelijkheid 75mm |                        |



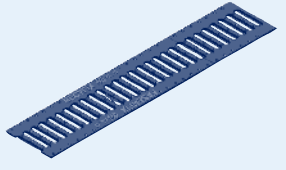
|                    | Lengte in mm | Artikelnr.             |
|--------------------|--------------|------------------------|
| <b>9565</b>        | 500          | 95650500               |
| <b>Maasrooster</b> | 1000         | 95651000               |
| - 30 x 10mm        |              | Artikelgroep: 09.05.10 |
| - verzinkt staal   |              |                        |



|                               | Artikelnr.             |
|-------------------------------|------------------------|
| <b>9567</b>                   | 9567                   |
| <b>Stankslot PVC</b>          | Artikelgroep: 09.05.10 |
| - voor verticale afloop 110mm |                        |
| - voor PE afvoergoot          |                        |



|                          | Lengte in mm | Artikelnr.             |
|--------------------------|--------------|------------------------|
| <b>9566</b>              | 500          | 95660500               |
| <b>Gietijzer rooster</b> |              | Artikelgroep: 09.05.10 |



|                             | Artikelnr.             |
|-----------------------------|------------------------|
| <b>9568</b>                 | 9568                   |
| <b>Roostervergrendeling</b> | Artikelgroep: 09.05.10 |
| - bevestigingsanker en bout |                        |




# 09.06 Hydranten


## Hydranten

- Voor de bescherming van kwetsbare onderdelen in ondergrondse leidingsystemen, zoals kranen en meters.
- Vervaardigd uit polypropyleen.


|   | Diameter in mm | Hoogte in mm | Artikelnr.                     |
|---|----------------|--------------|--------------------------------|
| <b>8232</b><br>Hydrant<br>- type Baby<br>- rond model | 160            | 230          | 8232<br>Artikelgroep: 09.06.05 |




|   | Diameter in mm | Hoogte in mm | Artikelnr.                     |
|---|----------------|--------------|--------------------------------|
| <b>8233</b><br>Hydrant<br>- type Junior<br>- rond model | 240            | 250          | 8233<br>Artikelgroep: 09.06.05 |



|  | Lengte in mm | Breedte in mm | Hoogte in mm | Artikelnr.                     |
|--|--------------|---------------|--------------|--------------------------------|
| <b>8234</b><br>Hydrant<br>- type Senior<br>- rechthoekig model | 400          | 270           | 310          | 8234<br>Artikelgroep: 09.06.05 |



|  | Lengte in mm | Breedte in mm | Hoogte in mm | Artikelnr.                     |
|--|--------------|---------------|--------------|--------------------------------|
| <b>8235</b><br>Hydrant<br>- type Maxi<br>- rechthoekig model | 520          | 370           | 305          | 8235<br>Artikelgroep: 09.06.05 |



Voor straatpotten en toebehoren verwijzen wij u naar Groep 16 'Metalen appendages en fittingen', zie blz. 230.





A large light blue rectangular area with horizontal ruling lines, intended for taking notes. The lines are evenly spaced and extend across the width of the page.

# Productgroep 10

PE Drukleidingen > PVC Drukleidingen > PP Drukleidingen  
> Afstandbediende afsluiters > C-PVC Programma >  
Blue-system programma > Binnen- en buitenriolering  
> Kabelbescherming en telecom > Milieu programma  
> Tanks > Folie en geotextielen > Halffabrikaten >  
RVS Programma > Malleable programma > Sanitair  
en verwarming > Metalen appendages en fittingen >  
Slangen en koppelingen > Pompen, filters en kabel  
> Lijm, reiniger en toebehoren > Bevestigingsmaterialen >  
Machines en gereedschappen

>> Tanks

# Milder

— VEELZIJDIG IN LEIDINGSYSTEMEN —

# 10.01 Tanks, bovengronds en ondergronds

## Bovengrondse opslag tanks

| Type   | Inhoud/liter | Lengte in mm | Breedte in mm | Hoogte in mm | Gewicht/kg | Artikelnr. |          |
|--|--------------|--------------|---------------|--------------|------------|------------|----------|
| <b>6303</b>                                      | PE 1100      | 1100         | 1400          | 720          | 1400       | 55         | 63031100 |
| <b>PE Opslagtank met bandage</b><br>- kleur: wit | PE 1500      | 1500         | 1560          | 720          | 1640       | 70         | 63031500 |
|  | PE 2000      | 2000         | 2070          | 720          | 1690       | 110        | 63032000 |
|  | PE 2500*     | 2500         | 1870          | 995          | 1650       | 115        | 63032500 |
|  | PE 3000*     | 3000         | 2230          | 995          | 1650       | 165        | 63033000 |
|  | PE 4000*     | 4000         | 2430          | 995          | 1950       | 235        | 63034000 |

Artikelgroep: 10.01.05



\* Uitsluitend voor wateropslag.

| Type   | Inhoud/liter | Lengte in mm | Breedte in mm | Hoogte in mm | Gewicht/kg | Artikelnr. |          |
|--|--------------|--------------|---------------|--------------|------------|------------|----------|
| <b>6309</b>  | PE 1100      | 1100         | 1400          | 720          | 1400       | 55         | 63091100 |
| <b>PE Opslagtank met bandage</b><br>- kleur: zwart | PE 1500      | 1500         | 1560          | 720          | 1640       | 70         | 63091500 |
|  | PE 2000      | 2000         | 2070          | 720          | 1690       | 110        | 63092000 |
|  | PE 3000*     | 3000         | 2230          | 995          | 1650       | 165        | 63093000 |
|  | PE 4000*     | 4000         | 2430          | 995          | 1950       | 235        | 63094000 |

Artikelgroep: 10.01.05

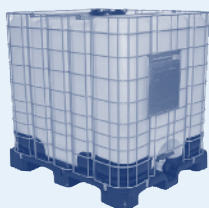


\* Uitsluitend voor wateropslag.

| Inhoud/liter | Lengte in mm | Breedte in mm | Hoogte in mm | Gewicht/kg | Artikelnr. |           |
|--------------|--------------|---------------|--------------|------------|------------|-----------|
| <b>63031</b> | 1000*        | 1200          | 1000         | 1170       | 69         | 630311000 |

Artikelgroep: 10.01.05

**PE Opslagtank**  
- op kunststof pallet  
- kleur: wit



\* Uitsluitend voor wateropslag.

| Inhoud/liter                   | Diameter in mm | Hoogte in mm | Vulopening | Draaggrepen | Artikelnr.    |         |
|--------------------------------|----------------|--------------|------------|-------------|---------------|---------|
| <b>6310</b>                    | 10*            | 240          | 320        | 120         | 1 draagbeugel | 6310010 |
| <b>PE Opslagtank</b><br>- rond | 15*            | 300          | 350        | 120         | 1 draagbeugel | 6310015 |
|                                | 30*            | 330          | 470        | 120         | 2 handgrepen  | 6310030 |
|                                | 50*            | 330          | 690        | 120         | 2 handgrepen  | 6310050 |
|                                | 80*            | 480          | 630        | 200         | 2 handgrepen  | 6310080 |
|                                | 120/125*       | 480          | 850        | 200         | 2 handgrepen  | 6310120 |

Artikelgroep: 10.01.05



\* Uitsluitend voor wateropslag.

## Bovengrondse opslagtanks

|                          | Inhoud/liter | Artikelnr.             |
|--------------------------|--------------|------------------------|
| <b>6313</b>              |              |                        |
| <b>Doseercontainer</b>   | 60           | 6313060                |
| - kleur: transparant wit | 100          | 6313100                |
|                          | 200          | 6313200                |
|                          | 300          | 6313300                |
|                          | 500          | 6313500                |
|                          |              | Artikelgroep: 10.01.05 |



N.B. informeer voor ingebruikname naar de chemische resistentie.

|                        | Inhoud/liter | Lengte in mm | Breedte in mm | Hoogte in mm | Artikelnr.             |
|------------------------|--------------|--------------|---------------|--------------|------------------------|
| <b>6311</b>            |              |              |               |              |                        |
| <b>PE Opslagtank</b>   | 60*          | 520          | 355           | 530          | 6311060                |
| - ovaal                | 100*         | 600          | 410           | 610          | 6311100                |
| - vulopening is 225 mm | 150*         | 680          | 470           | 710          | 6311150                |
|                        | 200*         | 810          | 500           | 770          | 6311200                |
|                        | 300*         | 880          | 610           | 880          | 6311300                |
|                        | 500*         | 1050         | 700           | 1010         | 6311500                |
|                        |              |              |               |              | Artikelgroep: 10.01.05 |



\* Uitsluitend voor wateropslag.

10

## Ondergrondse tanks

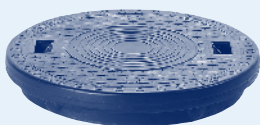
- Polyethyleen.
- Aan de buitenzijde voorzien van versterkingsringen.
- Licht, sterk en solide.
- Slagvast en chemisch resistent.

|                                | Inhoud/liter | Artikelnr.             |
|--------------------------------|--------------|------------------------|
| <b>9511</b>                    |              |                        |
| <b>PE Opslagtank</b>           | 2000*        | 95112000               |
| - voor ondergrondse toepassing | 3600*        | 95113600               |
| - zonder deksel(s)             | 5200*        | 95115200               |
|                                | 6800*        | 95116800               |
|                                |              | Artikelgroep: 10.01.05 |



\* Uitsluitend voor wateropslag.

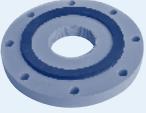
|  | Artikelnr.             |
|--|------------------------|
| <b>95111</b>                                 | 95111                  |
| <b>PE Deksel</b>                             | Artikelgroep: 10.01.05 |
| - voor artikelnr. 9511, PE ondergrondse tank |                        |



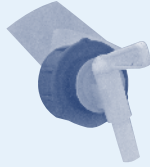
# 10.02 Toebehoren voor tanks

## Tanks toebehoren

|  | Afmeting | Artikelnr.             |
|--|----------|------------------------|
| <b>6305</b>  | 2"       | 6305                   |
| <b>PP Flens</b>                                    | 3"       | 6305300                |
| - met vlakke ring                                  |          | Artikelgroep: 10.02.05 |
| - voor artikelnr. 6303                             |          |                        |
| - standaard voorzien van 8 x verzinkte bout M10x40 |          |                        |



|                                | Afmeting | Artikelnr.             |
|--------------------------------|----------|------------------------|
| <b>6312</b>                    | NW 8     | 631208                 |
| <b>Afsluiter</b>               | NW 18    | 631218                 |
| - voor artikelnr. 6310 en 6311 |          | Artikelgroep: 10.02.05 |



|                        | Artikelnr.             |
|------------------------|------------------------|
| <b>6314</b>            | 6314                   |
| <b>Afsluiter</b>       | Artikelgroep: 10.02.05 |
| - voor artikelnr. 6303 |                        |



|                              | Artikelnr.             |
|------------------------------|------------------------|
| <b>63151</b>                 | 63151                  |
| <b>Tankverbinding T-stuk</b> | Artikelgroep: 10.02.05 |
| - met bouten en pakking      |                        |



|                          | Afmeting | Artikelnr.             |
|--------------------------|----------|------------------------|
| <b>63141</b>             | DN400    | 63141                  |
| <b>Schroefdeksel</b>     |          | Artikelgroep: 10.02.05 |
| - kleur: zwart           |          |                        |
| - met stalen klemband    |          |                        |
| - voor artikelnr. 6304   |          |                        |
| <b>63142</b>             | DN400    | 63142                  |
| <b>Schroefdeksel</b>     |          | Artikelgroep: 10.02.05 |
| - kleur zwart            |          |                        |
| - met kunststof klemband |          |                        |
| - voor artikelnr. 6303   |          |                        |



|                            | Artikelnr.             |
|----------------------------|------------------------|
| <b>63152</b>               | 63152                  |
| <b>Tankverbinding Knie</b> | Artikelgroep: 10.02.05 |
| - met bouten en pakking    |                        |



|   | Artikelnr.             |
|---|------------------------|
| <b>63153</b>                            | 63153                  |
| <b>Tankverbinding Rechte koppeling*</b> | Artikelgroep: 10.02.05 |
| - met bouten en pakking                 |                        |



\* Alleen geschikt voor tanks met inhoud 2500, 3000 en 4000 liter.

# Productgroep 11

PE Drukleidingen > PVC Drukleidingen > PP Drukleidingen  
> Afstandbediende afsluiters > C-PVC Programma >  
Blue-system programma > Binnen- en buitenriolering  
> Kabelbescherming en telecom > Milieu programma  
> Tanks > Folie en geotextielen > Halffabrikaten >  
RVS Programma > Malleable programma > Sanitair  
en verwarming > Metalen appendages en fittingen >  
Slangen en koppelingen > Pompen, filters en kabel  
> Lijm, reiniger en toebehoren > Bevestigingsmaterialen >  
Machines en gereedschappen

>> Folie en geotextielen

# Milder

— VEELZIJDIG IN LEIDINGSYSTEMEN —

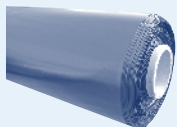
# 11.01 Folie en geotextielen

## Folie en geotextielen

- Fabrieksmatige zeilen zijn op aanvraag leverbaar.
- Op aanvraag leveren wij ook HDPE en EPDM folie. Deze zijn in verschillende breedten te leveren.
- Afwijkende dikten en/of rollengten zijn op aanvraag leverbaar.
- Voor andere folie of geotextielen vragen wij u contact op te nemen met ons verkoopteam.

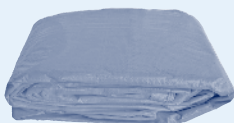
|  | Breedte in meter | Dikte in mm | Rollengte in meter | Oppervlakte       | Artikelnr.   |
|--|------------------|-------------|--------------------|-------------------|--------------|
| <b>2901</b>                            | 8                | 0,15        | 50                 | 400m <sup>2</sup> | 290101500800 |
| <b>LDPE Folie</b>                      | 12               | 0,15        | 50                 | 600m <sup>2</sup> | 290101501200 |
| - leverbaar op vele mogelijke breedten | 6                | 0,5         | 25                 | 150m <sup>2</sup> | 290102500600 |
| - toepassingen:                        | 6                | 0,5         | 100                | 600m <sup>2</sup> | 290110000600 |
| - afdekken van verontreinigde grond    | 6                | 1,0         | 100                | 600m <sup>2</sup> | 290110000601 |
| - afdekken van eps blokken             |                  |             |                    |                   |              |

Artikelgroep: 11.01.05



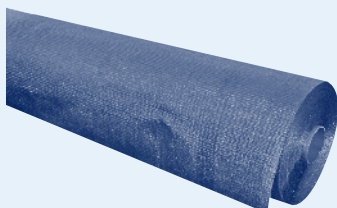
|                               | Afmeting in meter | Artikelnr. |
|-------------------------------|-------------------|------------|
| <b>1737</b>                   | 4 x 6             | 173700     |
| <b>Dekzeil</b>                | 6 x 8             | 173701     |
| - 100 gram per m <sup>2</sup> | 10 x 12           | 173702     |
| - kleur: oranje               |                   |            |

Artikelgroep: 11.01.05

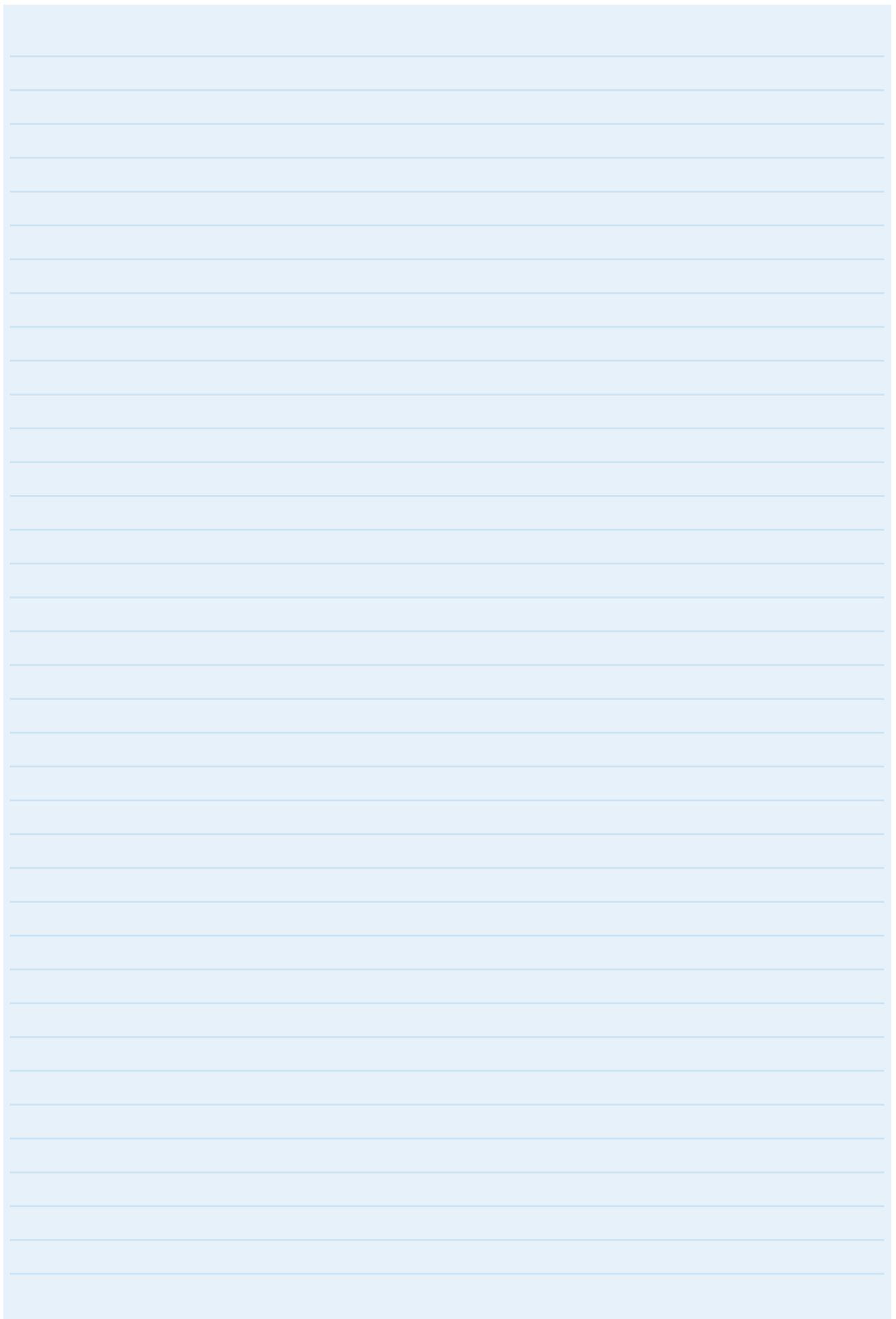


|                                  | Breedte in meter | Rollengte in meter | Oppervlakte       | Artikelnr. |
|----------------------------------|------------------|--------------------|-------------------|------------|
| <b>2902</b>                      | 1,00             | 100                | 100m <sup>2</sup> | 2902100    |
| <b>Weefsel (anti-worteldoek)</b> | 2,00             | 100                | 200m <sup>2</sup> | 2902205    |
| - weg- en waterbouw              | 3,05             | 100                | 305m <sup>2</sup> | 2902305    |
| - infiltratie                    | 4,25             | 100                | 425m <sup>2</sup> | 2902425    |
| - land- en tuinbouw              | 5,25             | 100                | 525m <sup>2</sup> | 2902525    |

Artikelgroep: 11.01.05



## Notities





A large light blue rectangular area with horizontal ruling lines, intended for taking notes. The lines are evenly spaced and extend across the width of the page.

# Productgroep 12

PE Drukleidingen > PVC Drukleidingen > PP Drukleidingen  
> Afstandbediende afsluiters > C-PVC Programma >  
Blue-system programma > Binnen- en buitenriolering  
> Kabelbescherming en telecom > Milieu programma  
> Tanks > Folie en geotextielen > Halffabrikaten >  
RVS Programma > Malleable programma > Sanitair  
en verwarming > Metalen appendages en fittingen >  
Slangen en koppelingen > Pompen, filters en kabel  
> Lijm, reiniger en toebehoren > Bevestigingsmaterialen >  
Machines en gereedschappen

>> Halffabrikaten

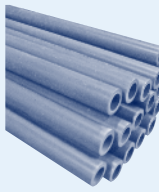
# Milder

— VEELZIJDIG IN LEIDINGSYSTEMEN —

# 12.01 Halffabrikaten buis

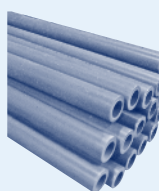
## PVC / PP Fittingbuis

|   | Buitendiameter x wanddikte in mm | Binnendiameter in mm | BSP draad<br>Uitwendig x inwendig | Artikelnr.             |
|---|----------------------------------|----------------------|-----------------------------------|------------------------|
| <b>1042</b>   |                                  |                      |                                   |                        |
| <b>PVC Fittingbuis</b>  |                                  |                      |                                   |                        |
| - dikwandige buis geschikt om zowel in- als uitwendig te voorzien van BSP-draad | 16,9 x 3,0                       | 10,9                 | 3/8" x 1/4"                       | 1042038014             |
|   | 21,1 x 3,4                       | 14,3                 | 1/2" x 3/8"                       | 1042012038             |
|   | 26,6 x 4,8                       | 17,0                 | 3/4" x 1/2"                       | 1042034012             |
|   | 33,4 x 5,7                       | 22,0                 | 1" x 3/4"                         | 1042100034             |
|   | 42,2 x 6,3                       | 29,5                 | 1 1/4" x 1"                       | 1042114100             |
|   | 48,1 x 5,1                       | 37,9                 | 1 1/2" x 1 1/4"                   | 1042112114             |
|   |                                  |                      |                                   | Artikelgroep: 12.01.05 |



- kleur: donkergrijs RAL 7011  
- lengte: standaard op 4 meter

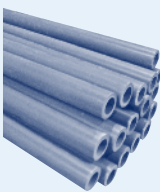
|                                 | Buitendiameter x wanddikte in mm | Binnendiameter in mm | Bestemd voor buitendiameter | Artikelnr.             |
|---------------------------------|----------------------------------|----------------------|-----------------------------|------------------------|
| <b>1112</b>                     |                                  |                      |                             |                        |
| <b>PP Fittingbuis</b>           |                                  |                      |                             |                        |
| - kleur: helblauw               | 21,1 x 3,5                       | 14,1                 | 1/2"                        | 1112012                |
| - lengte: standaard op 5 meter  | 26,9 x 4,5                       | 17,9                 | 3/4"                        | 1112034*               |
| - hoge trekvastheid             | 33,4 x 5,3                       | 22,8                 | 1"                          | 1112100                |
| - moeilijk ontvlambaar          | 42,4 x 6,2                       | 29,8                 | 1 1/4"                      | 1112114                |
| - eenvoudig draad op te snijden |                                  |                      |                             | Artikelgroep: 12.01.05 |



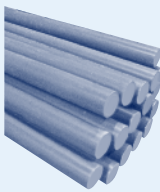
\* Artikelnr. 1112034: standaard lengte is 4 meter.

## PVC Holstaf / Volstaf

|                                | Buitendiameter x binnendiameter in mm | Artikelnr.             |
|--------------------------------|---------------------------------------|------------------------|
| <b>1046</b>                    |                                       |                        |
| <b>PVC Holstaf</b>             |                                       |                        |
| - kleur: donkergrijs RAL 7011  | 30 x 10                               | 1046030010             |
| - lengte: standaard op 2 meter | 35 x 15                               | 1046035015             |
| - industriekwaliteit           | 40 x 15                               | 1046040015             |
|                                | 40 x 20                               | 1046040020             |
|                                | 45 x 20                               | 1046045020             |
|                                | 50 x 20                               | 1046050020             |
|                                | 50 x 25                               | 1046050025             |
|                                | 60 x 20                               | 1046060020             |
|                                | 60 x 30                               | 1046060030             |
|                                | 65 x 30                               | 1046065030             |
|                                | 70 x 30                               | 1046070030             |
|                                | 80 x 40                               | 1046080040             |
|                                | 80 x 50                               | 1046080050             |
|                                | 90 x 25                               | 1046090025             |
|                                | 90 x 35                               | 1046090035             |
|                                | 90 x 60                               | 1046090060             |
|                                | 100 x 30                              | 1046100030             |
|                                | 100 x 50                              | 1046100050             |
|                                | 100 x 70                              | 1046100070             |
|                                | 110 x 50                              | 1046110050             |
|                                | 110 x 75                              | 1046110075             |
|                                | 120 x 40                              | 1046120040             |
|                                | 120 x 60                              | 1046120060             |
|                                | 120 x 75                              | 1046120075             |
|                                | 130 x 50                              | 1046130050             |
|                                | 130 x 90                              | 1046130090             |
|                                | 140 x 60                              | 1046140060             |
|                                | 150 x 70                              | 1046150070             |
|                                | 150 x 80                              | 1046150080             |
|                                | 160 x 100                             | 1046160100             |
|                                | 180 x 120                             | 1046180120             |
|                                | 200 x 100                             | 1046200100             |
|                                | 225 x 140                             | 1046225140             |
|                                | 250 x 150                             | 1046250150             |
|                                |                                       | Artikelgroep: 12.01.05 |



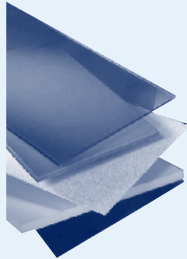
|                                | Diameter in mm | Artikelnr.             |
|--------------------------------|----------------|------------------------|
| <b>1045</b>                    |                |                        |
| <b>PVC Volstaf</b>             |                |                        |
| - kleur: donkergrijs RAL 7011  | 6              | 1045006                |
| - lengte: standaard op 2 meter | 8              | 1045008                |
| - industriekwaliteit           | 10             | 1045010                |
|                                | 12             | 1045012                |
|                                | 15             | 1045015                |
|                                | 20             | 1045020                |
|                                | 25             | 1045025                |
|                                | 30             | 1045030                |
|                                | 35             | 1045035                |
|                                | 40             | 1045040                |
|                                | 45             | 1045045                |
|                                | 50             | 1045050                |
|                                | 55             | 1045055                |
|                                | 60             | 1045060                |
|                                | 65             | 1045065                |
|                                | 70             | 1045070                |
|                                | 75             | 1045075                |
|                                | 80             | 1045080                |
|                                | 90             | 1045090                |
|                                | 100            | 1045100                |
|                                | 110            | 1045110                |
|                                | 120            | 1045120                |
|                                | 130            | 1045130                |
|                                | 150            | 1045150                |
|                                | 160            | 1045160                |
|                                |                | Artikelgroep: 12.01.05 |



## Kunststof platen

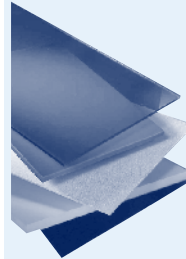
|                       | Dikte<br>in mm | Afmeting<br>in mm | Artikelnr. |
|-----------------------|----------------|-------------------|------------|
| <b>1043</b>           | 2              | 2000 x 1000       | 1043020    |
| <b>HDPE</b>           | 3              | 2000 x 1000       | 1043030    |
| <b>Industrieplaat</b> | 4              | 2000 x 1000       | 1043040    |
| - geëxtrudeerd        | 4              | 3000 x 1500       | 10430401   |
| - kleur: zwart        | 5              | 2000 x 1000       | 1043050    |
|                       | 5              | 3000 x 1500       | 10430501   |
|                       | 6              | 2000 x 1000       | 1043060    |
|                       | 6              | 3000 x 1500       | 10430601   |
|                       | 8              | 2000 x 1000       | 1043080    |
|                       | 8              | 3000 x 1500       | 10430801   |
|                       | 10             | 2000 x 1000       | 1043100    |
|                       | 10             | 3000 x 1500       | 10431001   |
|                       | 12             | 2000 x 1000       | 1043120    |
|                       | 12             | 3000 x 1500       | 10431201   |
|                       | 15             | 2000 x 1000       | 1043150    |
|                       | 15             | 3000 x 1500       | 10431501   |
|                       | 20             | 2000 x 1000       | 1043200    |
|                       | 20             | 3000 x 1500       | 10432001   |
|                       | 25             | 2000 x 1000       | 1043250    |
|                       | 25             | 3000 x 1500       | 10432501   |
|                       | 30             | 2000 x 1000       | 1043300    |
|                       | 30             | 3000 x 1500       | 10433001   |

Artikelgroep: 12.02.05



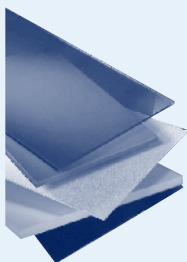
|                 | Dikte<br>in mm | Afmeting<br>in mm | Artikelnr. |
|-----------------|----------------|-------------------|------------|
| <b>1041</b>     | 3              | 2000 x 1000       | 1041030    |
| <b>PP plaat</b> | 5              | 2000 x 1000       | 1041050    |
| - geëxtrudeerd  | 6              | 2000 x 1000       | 1041060    |
| - kleur: crème  | 6              | 3000 x 1500       | 10410601   |
| RAL 7032        | 8              | 2000 x 1000       | 1041080    |
|                 | 8              | 3000 x 1500       | 10410801   |
|                 | 10             | 2000 x 1000       | 1041100    |
|                 | 10             | 3000 x 1500       | 10411001   |
|                 | 12             | 2000 x 1000       | 1041120    |
|                 | 12             | 3000 x 1500       | 10411201   |
|                 | 15             | 2000 x 1000       | 1041150    |
|                 | 15             | 3000 x 1500       | 10411501   |
|                 | 20             | 2000 x 1000       | 1041200    |
|                 | 20             | 3000 x 1500       | 10412001   |
|                 | 25             | 2000 x 1000       | 1041250    |
|                 | 25             | 3000 x 1500       | 10412501   |

Artikelgroep: 12.02.05



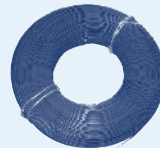
|                       | Dikte<br>in mm | Afmeting<br>in mm | Artikelnr. |
|-----------------------|----------------|-------------------|------------|
| <b>1044</b>           | 1              | 2000 x 1000       | 1044010    |
| <b>PVC Plaat</b>      | 2              | 2000 x 1000       | 1044020    |
| - geëxtrudeerd        | 2              | 3000 x 1500       | 10440201   |
| - type PVC-CAW        | 3              | 2000 x 1000       | 1044030    |
| - kleur: donkergrijs  | 3              | 3000 x 1500       | 10440301   |
| RAL 7011              | 4              | 2000 x 1000       | 1044040    |
| - industrie kwaliteit | 4              | 3000 x 1500       | 10440401   |
|                       | 5              | 2000 x 1000       | 1044050    |
|                       | 5              | 3000 x 1500       | 10440501   |
|                       | 6              | 2000 x 1000       | 1044060    |
|                       | 6              | 3000 x 1500       | 10440601   |
|                       | 8              | 2000 x 1000       | 1044080    |
|                       | 8              | 3000 x 1500       | 10440801   |
|                       | 10             | 2000 x 1000       | 1044100    |
|                       | 10             | 3000 x 1500       | 10441001   |
|                       | 12             | 2000 x 1000       | 1044120    |
|                       | 12             | 3000 x 1500       | 10441201   |
|                       | 15             | 2000 x 1000       | 1044150    |
|                       | 15             | 3000 x 1500       | 10441501   |
|                       | 20             | 2000 x 1000       | 1044200    |
|                       | 25             | 2000 x 1000       | 1044250    |
|                       | 30             | 2000 x 1000       | 1044300    |
|                       | 35             | 2000 x 1000       | 1044350    |

Artikelgroep: 12.02.05



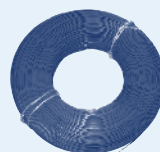
|                    | Diameter<br>in mm | Kg<br>per haspel | Artikelnr.             |
|--------------------|-------------------|------------------|------------------------|
| <b>1039</b>        | 3                 | ca. 2            | 1039003                |
| <b>PE Lasdraad</b> | 4                 | ca. 2            | 1039004                |
| - rond             | 5                 | ca. 2            | 1039005                |
| - per haspel       |                   |                  | Artikelgroep: 12.02.05 |

Andere soorten lasdraad zijn op aanvraag leverbaar.




|                     | Diameter in mm | Artikelnr.             |
|---------------------|----------------|------------------------|
| <b>10391</b>        | 3 *            | 103910003              |
| <b>PVC Lasdraad</b> | 4              | 103910004              |
| - rond              | 5              | 103910005              |
| - per meter         |                | Artikelgroep: 12.02.05 |

\* Per 2 meter.




## 12.03 Acrylaat producten

### Acrylaat buis

|   | Buitendiameter<br>x binnendiameter in mm | Wanddikte in mm | Lengte in mm | Artikelnr. |
|---|--|-----------------|--------------|------------|
| <b>1120</b>   | 10 x 7                                   | 1,5             | 2500         | 1120010007 |
| <b>Acrylaat buis</b>  | 12 x 6                                   | 3               | 2500         | 1120012006 |
| - glashelder geëxtrudeerd   | 12 x 8                                   | 2               | 2500         | 1120012008 |
|   | 13 x 9                                   | 2               | 2500         | 1120013009 |
|   | 15 x 11                                  | 2               | 2500         | 1120015011 |
|  | 16 x 12                                  | 2               | 2500         | 1120016012 |
|   | 20 x 14                                  | 3               | 2500         | 1120020014 |
|   | 20 x 16                                  | 2               | 2500         | 1120020016 |
|   | 22 x 18                                  | 2               | 2500         | 1120022018 |
|   | 24 x 20                                  | 2               | 2500         | 1120024020 |
|   | 25 x 21                                  | 2               | 2500         | 1120025021 |
|   | 30 x 22                                  | 4               | 3000         | 1120030022 |
|   | 30 x 24                                  | 3               | 3000         | 1120030024 |
|   | 32 x 26                                  | 3               | 3000         | 1120032026 |
|   | 32 x 28                                  | 2               | 3000         | 1120032028 |
|   | 40 x 30                                  | 5               | 3000         | 1120040030 |
|   | 40 x 32                                  | 4               | 3000         | 1120040032 |
|   | 40 x 34                                  | 3               | 3000         | 1120040034 |
|   | 40 x 36                                  | 2               | 3000         | 1120040036 |
|   | 50 x 40                                  | 5               | 2500         | 1120050040 |
|   | 50 x 42                                  | 4               | 2500         | 1120050042 |
|   | 50 x 44                                  | 3               | 2500         | 1120050044 |
|   | 50 x 46                                  | 2               | 2500         | 1120050046 |
|   | 60 x 54                                  | 3               | 2500         | 1120060054 |
|   | 60 x 56                                  | 2               | 2500         | 1120060056 |
|   | 70 x 60                                  | 5               | 2050         | 1120070060 |
|   | 70 x 62                                  | 4               | 2050         | 1120070062 |
|   | 70 x 64                                  | 3               | 2050         | 1120070064 |
|   | 80 x 70                                  | 5               | 2050         | 1120080070 |
|   | 80 x 72                                  | 4               | 2050         | 1120080072 |
|   | 80 x 74                                  | 3               | 2050         | 1120080074 |
|   | 100 x 90                                 | 5               | 2050         | 1120100090 |
|   | 100 x 92                                 | 4               | 2050         | 1120100092 |
|   | 100 x 94                                 | 3               | 2050         | 1120100094 |
|   | 110 x 100                                | 5               | 2050         | 1120110100 |
|   | 110 x 102                                | 4               | 2050         | 1120110102 |
|   | 110 x 104                                | 3               | 2050         | 1120110104 |
|   | 120 x 110                                | 5               | 2050         | 1120120110 |
|   | 120 x 112                                | 4               | 2050         | 1120120112 |
|   | 120 x 114                                | 3               | 2050         | 1120120114 |
|   | 150 x 140                                | 5               | 2050         | 1120150140 |
|   | 150 x 142                                | 4               | 2050         | 1120150142 |
|   | 150 x 144                                | 3               | 2050         | 1120150144 |
|   | 160 x 150                                | 5               | 2050         | 1120160150 |
|   | 160 x 152                                | 4               | 2050         | 1120160152 |
|   | 160 x 154                                | 3               | 2050         | 1120160154 |
|   | 200 x 190                                | 5               | 2050         | 1120200190 |
|   | 200 x 192                                | 4               | 2050         | 1120200192 |
|   | 200 x 194                                | 3               | 2050         | 1120200194 |
|   | 240 x 230                                | 5               | 2050         | 1120240230 |
|   | 250 x 240                                | 5               | 2050         | 1120250240 |
|   | 250 x 242                                | 4               | 2050         | 1120250242 |

Artikelgroep: 12.03.05

## Acrylaat buis

|   | Buitendiameter<br>x binnendiameter in mm | Wanddikte in mm | Lengte in mm | Artikelnr. |
|---|--|-----------------|--------------|------------|
| <b>1100</b><br>Acrylaat buis<br>- glashelder gegoten<br> | 50 x 40                                  | 5               | 2030         | 1100050040 |
|   | 50 x 42                                  | 4               | 2030         | 1100050042 |
|   | 50 x 44                                  | 3               | 2030         | 1100050044 |
|   | 60 x 50                                  | 5               | 2030         | 1100060050 |
|   | 60 x 52                                  | 4               | 2030         | 1100060052 |
|   | 60 x 54                                  | 3               | 2030         | 1100060054 |
|   | 64 x 54                                  | 5               | 2030         | 1100064054 |
|   | 64 x 56                                  | 4               | 2030         | 1100064056 |
|   | 64 x 58                                  | 3               | 2030         | 1100064058 |
|   | 70 x 60                                  | 5               | 2030         | 1100070060 |
|   | 70 x 62                                  | 4               | 2030         | 1100070062 |
|   | 70 x 64                                  | 3               | 2030         | 1100070064 |
|   | 76 x 66                                  | 5               | 2030         | 1100076066 |
|   | 76 x 68                                  | 4               | 2030         | 1100076068 |
|   | 80 x 70                                  | 5               | 2030         | 1100080070 |
|   | 80 x 72                                  | 4               | 2030         | 1100080072 |
|   | 80 x 74                                  | 3               | 2030         | 1100080074 |
|   | 90 x 80                                  | 5               | 2030         | 1100090080 |
|   | 90 x 82                                  | 4               | 2030         | 1100090082 |
|   | 90 x 84                                  | 3               | 2030         | 1100090084 |
|   | 100 x 90                                 | 5               | 2030         | 1100100090 |
|   | 100 x 92                                 | 4               | 2030         | 1100100092 |
|   | 100 x 94                                 | 3               | 2030         | 1100100094 |
|   | 110 x 100                                | 5               | 2030         | 1100110100 |
|   | 110 x 102                                | 4               | 2030         | 1100110102 |
|   | 110 x 104                                | 3               | 2030         | 1100110104 |
|   | 120 x 110                                | 5               | 2030         | 1100120110 |
|   | 125 x 115                                | 5               | 2030         | 1100125115 |
|   | 125 x 117                                | 4               | 2030         | 1100125117 |
|   | 130 x 120                                | 5               | 2030         | 1100130120 |
|   | 134 x 124                                | 5               | 2030         | 1100134124 |
|   | 134 x 126                                | 4               | 2030         | 1100134126 |
|   | 150 x 140                                | 5               | 2030         | 1100150140 |
|   | 150 x 142                                | 4               | 2030         | 1100150142 |
|   | 150 x 144                                | 3               | 2030         | 1100150144 |
|   | 153 x 145                                | 4               | 2030         | 1100153145 |
|   | 160 x 150                                | 5               | 2030         | 1100160150 |
| 160 x 152   | 4  | 2030            | 1100160152   |            |
| 160 x 154   | 3  | 2030            | 1100160154   |            |
| 164 x 154   | 5  | 2030            | 1100164154   |            |
| 164 x 156   | 4  | 2030            | 1100164156   |            |
| 168 x 158   | 5  | 2030            | 1100168158   |            |
| 168 x 160   | 4  | 2030            | 1100168160   |            |
| 172 x 162   | 5  | 2030            | 1100172162   |            |
| 172 x 166   | 4  | 2030            | 1100172166   |            |
| 200 x 190   | 5  | 2030            | 1100200190   |            |
| 200 x 192   | 4  | 2030            | 1100200192   |            |
| 220 x 210   | 5  | 2030            | 1100220210   |            |
| 220 x 214   | 4  | 2030            | 1100220214   |            |
| 240 x 232   | 4  | 2030            | 1100240232   |            |
| 300 x 290   | 5  | 2030            | 1100300290   |            |
| 300 x 292   | 4  | 2030            | 1100300292   |            |
| 400 x 390   | 5  | 2160            | 1100400390   |            |
| 400 x 392   | 4  | 2160            | 1100400392   |            |
| 500 x 490   | 5  | 2180            | 1100500490   |            |

Artikelgroep: 12.03.05

Acrylaat plaat, rondstaf en vierkantstaf zijn op aanvraag leverbaar.

A large light blue rectangular area with horizontal ruling lines, intended for taking notes. The lines are evenly spaced and extend across the width of the page.

# Productgroep 13

PE Drukleidingen > PVC Drukleidingen > PP Drukleidingen  
> Afstandbediende afsluiters > C-PVC Programma >  
Blue-system programma > Binnen- en buitenriolering  
> Kabelbescherming en telecom > Milieu programma  
> Tanks > Folie en geotextielen > Halffabrikaten >  
RVS Programma > Malleable programma > Sanitair  
en verwarming > Metalen appendages en fittingen >  
Slangen en koppelingen > Pompen, filters en kabel  
> Lijm, reiniger en toebehoren > Bevestigingsmaterialen >  
Machines en gereedschappen

>> RVS Programma

# Milder

— VEELZIJDIG IN LEIDINGSYSTEMEN —



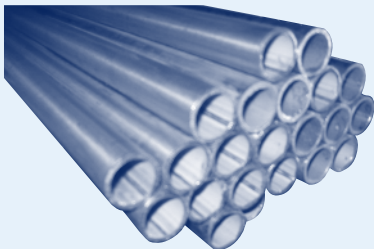
# 13.01 RVS Buis

## RVS Buis (RVS 316)

### 2505

#### RVS Buis

- gelast en gegloeid
- lengten: standaard op 6 meter
- gemakkelijk draad op te snijden



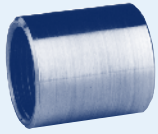
| Buitendiameter x wanddikte | Artikelnr. |
|----------------------------|------------|
| 12 x 1,5 (1/4")            | 250512015  |
| 13,5 x 2,3 (1/4")          | 250513523  |
| 21,3 x 2,6 (1/2")          | 250521326  |
| 21,3 x 2,9                 | 250521329  |
| 26,9 x 2,6 (3/4")          | 250526926  |
| 33,7 x 3,2 (1")            | 250533732  |
| 42,16 x 2,77               | 250542127  |
| 42,4 x 3,2 (1 1/4")        | 250542432  |
| 48,3 x 2,0                 | 250548320  |
| 48,3 x 2,6                 | 250548326  |
| 48,3 x 3,2 (1 1/2")        | 250548332  |
| 48,3 x 3,6                 | 250548336  |
| 60,3 x 2,0                 | 250560320  |
| 60,3 x 3,0                 | 250560330  |
| 60,3 x 3,2 (2")            | 250560332  |
| 60,3 x 3,6                 | 250560336  |
| 76,1 x 2,0                 | 250576120  |
| 76,1 x 3,0                 | 250576130  |
| 76,1 x 3,6 (2 1/2")        | 250576136  |
| 88,9 x 2,0                 | 250588920  |
| 88,9 x 3,0 (3")            | 250588930  |
| 88,9 x 4,0                 | 250588940  |
| 101,6 x 2,0 (3 1/2")       | 250590120  |
| 101,6 x 3,0                | 250590130  |
| 101,6 x 4,0                | 250590140  |
| 114,3 x 2,0 (4")           | 250591420  |
| 114,3 x 3,0                | 250591430  |
| 114,3 x 4,0                | 250591440  |

Artikelgroep: 13.01.05

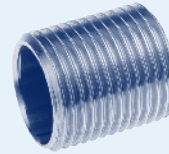
## RVS Draadfittingen (RVS 316)

• Voor technische specificaties kunt u contact opnemen met de afdeling verkoop.

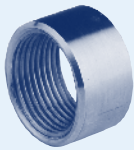
|  | Afmeting               | Artikelnr. |
|--|------------------------|------------|
| <b>323</b><br><b>RVS Lassok</b><br>- 2 x binnendraad | 1/8"                   | 323018     |
|  | 1/4"                   | 323014     |
|  | 3/8"                   | 323038     |
|  | 1/2"                   | 323012     |
|  | 3/4"                   | 323034     |
|  | 1"                     | 323100     |
|  | 1 1/4"                 | 323114     |
|  | 1 1/2"                 | 323112     |
|  | 2"                     | 323200     |
|  | 2 1/2"                 | 323212     |
|  | 3"                     | 323300     |
|  | 4"                     | 323400     |
|  | Artikelgroep: 13.02.05 |            |



|   | Afmeting               | Artikelnr. |
|---|------------------------|------------|
| <b>311</b><br><b>RVS Draadnippel</b><br>- met buitendraad | 1/8"                   | 311018     |
|   | 1/4"                   | 311014     |
|   | 3/8"                   | 311038     |
|   | 1/2"                   | 311012     |
|   | 3/4"                   | 311034     |
|   | 1"                     | 311100     |
|   | 1 1/4"                 | 311114     |
|   | 1 1/2"                 | 311112     |
|   | 2"                     | 311200     |
|   | 2 1/2"                 | 311212     |
|   | 3"                     | 311300     |
|   | 4"                     | 311400     |
|   | Artikelgroep: 13.02.05 |            |



|   | Afmeting               | Artikelnr. |
|---|------------------------|------------|
| <b>324</b><br><b>RVS Halve sok</b><br>- 1 x binnendraad | 1/8"                   | 324018     |
|   | 1/4"                   | 324014     |
|   | 3/8"                   | 324038     |
|   | 1/2"                   | 324012     |
|   | 3/4"                   | 324034     |
|   | 1"                     | 324100     |
|   | 1 1/4"                 | 324114     |
|   | 1 1/2"                 | 324112     |
|   | 2"                     | 324200     |
|   | 2 1/2"                 | 324212     |
|   | 3"                     | 324300     |
|   | 4"                     | 324400     |
|   | Artikelgroep: 13.02.05 |            |



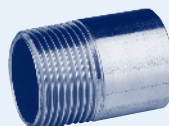
|  | Afmeting               | Artikelnr. |
|--|------------------------|------------|
| <b>312</b><br><b>RVS Pijpnippel</b><br>- 2 x buitendraad (BSP) | 1/8" x 30              | 312018     |
|  | 1/4" x 40              | 312014     |
|  | 3/8" x 40              | 312038     |
|  | 1/2" x 60              | 312012     |
|  | 1/2" x 100             | 312012100  |
|  | 1/2" x 150             | 312012150  |
|  | 3/4" x 60              | 312034     |
|  | 1" x 60                | 312100     |
|  | 1" x 100               | 312100100  |
|  | 1 1/4" x 80            | 312114     |
|  | 1 1/2" x 80            | 312112     |
|  | 2" x 100               | 312200     |
|  | 2 1/2" x 100           | 312212     |
|  | 3" x 120               | 312300     |
|  | 4" x 120               | 312400     |
|  | Artikelgroep: 13.02.05 |            |



|  | Afmeting               | Artikelnr. |
|--|------------------------|------------|
| <b>431</b><br><b>RVS Dubbele nippel</b><br>- 2 x buitendraad | 1/8"                   | 431018     |
|  | 1/4"                   | 431014     |
|  | 3/8"                   | 431038     |
|  | 1/2"                   | 431012     |
|  | 3/4"                   | 431034     |
|  | 1"                     | 431100     |
|  | 1 1/4"                 | 431114     |
|  | 1 1/2"                 | 431112     |
|  | 2"                     | 431200     |
|  | 2 1/2"                 | 431212     |
|  | 3"                     | 431300     |
|  | 4"                     | 431400     |
|  | Artikelgroep: 13.02.05 |            |



|   | Afmeting               | Artikelnr. |
|---|------------------------|------------|
| <b>313</b><br><b>RVS Lasnippel</b><br>- 1 x buitendraad | 1/8"                   | 313018     |
|   | 1/4"                   | 313014     |
|   | 3/8"                   | 313038     |
|   | 1/2"                   | 313012     |
|   | 3/4"                   | 313034     |
|   | 1"                     | 313100     |
|   | 1 1/4"                 | 313114     |
|   | 1 1/2"                 | 313112     |
|   | 2"                     | 313200     |
|   | 2 1/2"                 | 313212     |
|   | 3"                     | 313300     |
|   | 4"                     | 313400     |
|   | Artikelgroep: 13.02.05 |            |

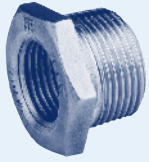


# 13.02 Fittingen voor RVS leidingen

## RVS Draadfittingen (RVS 316)

### 441

RVS Verloopring  
- buitendraad  
x binnendraad



| Afmeting        | Artikelnr. |
|-----------------|------------|
| 1/4" x 1/8"     | 441014018  |
| 3/8" x 1/8"     | 441038018  |
| 3/8" x 1/4"     | 441038014  |
| 1/2" x 1/8"     | 441012018  |
| 1/2" x 1/4"     | 441012014  |
| 1/2" x 3/8"     | 441012038  |
| 3/4" x 1/4"     | 441034014  |
| 3/4" x 3/8"     | 441034038  |
| 3/4" x 1/2"     | 441034012  |
| 1" x 1/8"       | 441100018  |
| 1" x 1/4"       | 441100014  |
| 1" x 3/8"       | 441100038  |
| 1" x 1/2"       | 441100012  |
| 1" x 3/4"       | 441100034  |
| 1 1/4" x 1/2"   | 441114012  |
| 1 1/4" x 3/4"   | 441114034  |
| 1 1/4" x 1"     | 441114100  |
| 1 1/2" x 3/8"   | 441112038  |
| 1 1/2" x 1/2"   | 441112012  |
| 1 1/2" x 3/4"   | 441112034  |
| 1 1/2" x 1"     | 441112100  |
| 1 1/2" x 1 1/4" | 441112114  |
| 2" x 1/2"       | 441200012  |
| 2" x 3/4"       | 441200034  |
| 2" x 1"         | 441200100  |
| 2" x 1 1/4"     | 441200114  |
| 2" x 1 1/2"     | 441200112  |
| 2 1/2" x 1"     | 441212100  |
| 2 1/2" x 1 1/4" | 441212114  |
| 2 1/2" x 1 1/2" | 441212112  |
| 2 1/2" x 2"     | 441212200  |
| 3" x 2"         | 441300200  |
| 3" x 2 1/2"     | 441300212  |
| 4" x 2"         | 441400200  |
| 4" x 2 1/2"     | 441400212  |
| 4" x 3"         | 441400300  |

Artikelpgroep: 13.02.05

### 442

RVS Verloopsok  
- 2 x binnendraad

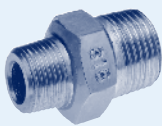


| Afmeting        | Artikelnr. |
|-----------------|------------|
| 1/4" x 1/8"     | 442014018  |
| 3/8" x 1/8"     | 442038018  |
| 3/8" x 1/4"     | 442038014  |
| 1/2" x 1/8"     | 442012018  |
| 1/2" x 1/4"     | 442012014  |
| 1/2" x 3/8"     | 442012038  |
| 3/4" x 1/4"     | 442034014  |
| 3/4" x 3/8"     | 442034038  |
| 3/4" x 1/2"     | 442034012  |
| 1" x 1/4"       | 442100014  |
| 1" x 3/8"       | 442100038  |
| 1" x 1/2"       | 442100012  |
| 1" x 3/4"       | 442100034  |
| 1 1/4" x 1/4"   | 442114014  |
| 1 1/4" x 3/8"   | 442114038  |
| 1 1/4" x 1/2"   | 442114012  |
| 1 1/4" x 3/4"   | 442114034  |
| 1 1/4" x 1"     | 442114100  |
| 1 1/2" x 3/8"   | 442112038  |
| 1 1/2" x 1/2"   | 442112012  |
| 1 1/2" x 3/4"   | 442112034  |
| 1 1/2" x 1"     | 442112100  |
| 1 1/2" x 1 1/4" | 442112114  |
| 2" x 1/2"       | 442200012  |
| 2" x 3/4"       | 442200034  |
| 2" x 1"         | 442200100  |
| 2" x 1 1/4"     | 442200114  |
| 2" x 1 1/2"     | 442200112  |
| 2 1/2" x 1"     | 442212100  |
| 2 1/2" x 1 1/2" | 442212112  |
| 2 1/2" x 2"     | 442212200  |
| 3" x 2"         | 442300200  |
| 3" x 2 1/2"     | 442300212  |
| 4" x 2"         | 442400200  |
| 4" x 2 1/2"     | 442400212  |
| 4" x 3"         | 442400300  |

Artikelpgroep: 13.02.05

### 451

RVS Verloopnippel  
- 2 x buitendraad

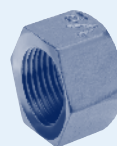


| Afmeting        | Artikelnr. |
|-----------------|------------|
| 1/4" x 1/8"     | 451014018  |
| 3/8" x 1/8"     | 451038018  |
| 3/8" x 1/4"     | 451038014  |
| 1/2" x 1/8"     | 451012018  |
| 1/2" x 1/4"     | 451012014  |
| 1/2" x 3/8"     | 451012038  |
| 3/4" x 1/4"     | 451034014  |
| 3/4" x 3/8"     | 451034038  |
| 3/4" x 1/2"     | 451034012  |
| 1" x 1/4"       | 451100014  |
| 1" x 3/8"       | 451100038  |
| 1" x 1/2"       | 451100012  |
| 1" x 3/4"       | 451100034  |
| 1 1/4" x 1/2"   | 451114012  |
| 1 1/4" x 3/4"   | 451114034  |
| 1 1/4" x 1"     | 451114100  |
| 1 1/2" x 1/2"   | 451112012  |
| 1 1/2" x 3/4"   | 451112034  |
| 1 1/2" x 1"     | 451112100  |
| 1 1/2" x 1 1/4" | 451112114  |
| 2" x 1"         | 451200100  |
| 2" x 1 1/4"     | 451200114  |
| 2" x 1 1/2"     | 451200112  |
| 2 1/2" x 1 1/2" | 451212112  |
| 2 1/2" x 2"     | 451212200  |
| 3" x 2"         | 451300200  |
| 3" x 2 1/2"     | 451300212  |
| 4" x 2"         | 451400200  |
| 4" x 2 1/2"     | 451400212  |
| 4" x 3"         | 451400300  |

Artikelpgroep: 13.02.05

### 463

RVS Eindkap  
- met zeskant  
- met binnendraad



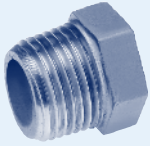
| Afmeting | Artikelnr. |
|----------|------------|
| 1/8"     | 463018     |
| 1/4"     | 463014     |
| 3/8"     | 463038     |
| 1/2"     | 463012     |
| 3/4"     | 463034     |
| 1" *     | 463100     |
| 1 1/4" * | 463114     |
| 1 1/2" * | 463112     |
| 2" *     | 463200     |
| 2 1/2" * | 463212     |
| 3" *     | 463300     |
| 4" *     | 463400     |

Artikelpgroep: 13.02.05

\* met achtkant

## RVS Draadfittingen (RVS 316)

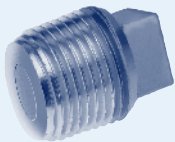
|  | Afmeting | Artikelnr.             |
|--|----------|------------------------|
| <b>452</b><br><b>RVS Plug</b><br>- met zeskant/<br>achtkant<br>- met buitendraad | 1/8"     | 452018                 |
|  | 1/4"     | 452014                 |
|  | 3/8"     | 452038                 |
|  | 1/2"     | 452012                 |
|  | 3/4"     | 452034                 |
|  | 1"       | 452100                 |
|  | 1 1/4"   | 452114                 |
|  | 1 1/2"   | 452112                 |
|  | 2"       | 452200                 |
|  | 2 1/2"   | 452212                 |
|  | 3"       | 452300                 |
|  | 4"       | 452400                 |
|  |          | Artikelgroep: 13.02.05 |



|   | Afmeting | Artikelnr.             |
|---|----------|------------------------|
| <b>414</b><br><b>RVS Knie 90°</b><br>- binnendraad x<br>buitendraad | 1/8"     | 414018                 |
|   | 1/4"     | 414014                 |
|   | 3/8"     | 414038                 |
|   | 1/2"     | 414012                 |
|   | 3/4"     | 414034                 |
|   | 1"       | 414100                 |
|   | 1 1/4"   | 414114                 |
|   | 1 1/2"   | 414112                 |
|   | 2"       | 414200                 |
|   | 2 1/2"   | 414212                 |
|   | 3"       | 414300                 |
|   | 4"       | 414400                 |
|   |          | Artikelgroep: 13.02.05 |



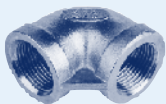
|  | Afmeting | Artikelnr.             |
|--|----------|------------------------|
| <b>433</b><br><b>RVS Plug</b><br>- met vierkant<br>- met buitendraad | 1/8"     | 433018                 |
|  | 1/4"     | 433014                 |
|  | 3/8"     | 433038                 |
|  | 1/2"     | 433012                 |
|  | 3/4"     | 433034                 |
|  | 1"       | 433100                 |
|  | 1 1/4"   | 433114                 |
|  | 1 1/2"   | 433112                 |
|  | 2"       | 433200                 |
|  | 2 1/2"   | 433212                 |
|  | 3"       | 433300                 |
|  | 4"       | 433400                 |
|  |          | Artikelgroep: 13.02.05 |



|   | Afmeting | Artikelnr. |
|---|----------|------------|
| <b>322</b><br><b>RVS Bocht 90°</b><br>- 2 x buitendraad | 1/8"     | 322018     |
|   | 1/4"     | 322014     |
|   | 3/8"     | 322038     |
|   | 1/2"     | 322012     |
|   | 3/4"     | 322034     |
|   | 1"       | 322100     |
|   | 1 1/4"   | 322114     |
|   | 1 1/2"   | 322112     |
|   | 2"       | 322200     |
|   |          |            |



|  | Afmeting | Artikelnr.             |
|--|----------|------------------------|
| <b>411</b><br><b>RVS Knie 90°</b><br>- 2 x binnendraad | 1/8"     | 411018                 |
|  | 1/4"     | 411014                 |
|  | 3/8"     | 411038                 |
|  | 1/2"     | 411012                 |
|  | 3/4"     | 411034                 |
|  | 1"       | 411100                 |
|  | 1 1/4"   | 411114                 |
|  | 1 1/2"   | 411112                 |
|  | 2"       | 411200                 |
|  | 2 1/2"   | 411212                 |
|  | 3"       | 411300                 |
|  | 4"       | 411400                 |
|  |          | Artikelgroep: 13.02.05 |



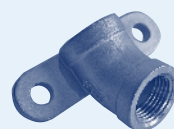
|  | Afmeting | Artikelnr.             |
|--|----------|------------------------|
| <b>413</b><br><b>RVS Knie 45°</b><br>- 2 x binnendraad | 1/8"     | 413018                 |
|  | 1/4"     | 413014                 |
|  | 3/8"     | 413038                 |
|  | 1/2"     | 413012                 |
|  | 3/4"     | 413034                 |
|  | 1"       | 413100                 |
|  | 1 1/4"   | 413114                 |
|  | 1 1/2"   | 413112                 |
|  | 2"       | 413200                 |
|  | 2 1/2"   | 413212                 |
|  | 3"       | 413300                 |
|  | 4"       | 413400                 |
|  |          | Artikelgroep: 13.02.05 |



|   | Afmeting        | Artikelnr. |
|---|-----------------|------------|
| <b>411</b><br><b>RVS Verloopknie 90°</b><br>- 2 x binnendraad | 1/4" x 1/8"     | 411014018  |
|   | 3/8" x 1/4"     | 411038014  |
|   | 1/2" x 3/8"     | 411012038  |
|   | 3/4" x 1/2"     | 411034012  |
|   | 1" x 1/2"       | 41100012   |
|   | 1" x 3/4"       | 41100034   |
|   | 1 1/4" x 3/4"   | 411114034  |
|   | 1 1/4" x 1"     | 411114100  |
|   | 1 1/2" x 1"     | 411112100  |
|   | 1 1/2" x 1 1/4" | 411112114  |
|   | 2" x 1 1/2"     | 411200112  |
|   |                 |            |



|  | Afmeting | Artikelnr.             |
|--|----------|------------------------|
| <b>464</b><br><b>RVS Muurplaat 45°</b> | 1/2"     | 464012                 |
|  |          | Artikelgroep: 13.02.05 |



13

# 13.02 Fittingen voor RVS leidingen

## RVS Draadfittingen (RVS 316)

|   | Afmeting | Artikelnr.             |
|---|----------|------------------------|
| <b>465</b><br><b>RVS Muurplaat 90°</b><br> | 1"       | 465100                 |
|   |          | Artikelgroep: 13.02.05 |

|  | Afmeting | DN  | Artikelnr. |
|--|----------|-----|------------|
| <b>426</b><br><b>RVS Draadflens</b><br>- geboord<br>- met binnendraad<br> | 1/2"     | 15  | 426012     |
|  | 3/4"     | 20  | 426034     |
|  | 1"       | 25  | 426100     |
|  | 1 1/4"   | 32  | 426114     |
|  | 1 1/2"   | 40  | 426112     |
|  | 2"       | 50  | 426200     |
|  | 2 1/2"   | 65  | 426212     |
|  | 3"       | 80  | 426300     |
|  | 4"       | 100 | 426400     |
|  |          |     |            |

|   | Afmeting | Artikelnr.             |
|---|----------|------------------------|
| <b>412</b><br><b>RVS T-stuk 90°</b><br>- 3 x binnendraad<br>- recht en verlopend<br> | 1/8"     | 412018                 |
|   | 1/4"     | 412014                 |
|   | 3/8"     | 412038                 |
|   | 1/2"     | 412012                 |
|   | 3/4"     | 412034                 |
|   | 1"       | 412100                 |
|   | 1 1/4"   | 412114                 |
|   | 1 1/2"   | 412112                 |
|   | 2"       | 412200                 |
|   | 2 1/2"   | 412212                 |
|   | 3"       | 412300                 |
| 4"  | 412400   |                        |
|   |          | Artikelgroep: 13.02.05 |

|   | Afmeting | Artikelnr.             |
|---|----------|------------------------|
| <b>421</b><br><b>RVS 3-Delige koppeling</b><br>- 2 x binnendraad<br>- conische dichting*<br> | 1/8"     | 421018                 |
|   | 1/4"     | 421014                 |
|   | 3/8"     | 421038                 |
|   | 1/2"     | 421012                 |
|   | 3/4"     | 421034                 |
|   | 1"       | 421100                 |
|   | 1 1/4"   | 421114                 |
|   | 1 1/2"   | 421112                 |
|   | 2"       | 421200                 |
|   | 2 1/2"   | 421212                 |
|   | 3"       | 421300                 |
| 4"  | 421400   |                        |
|   |          | Artikelgroep: 13.02.05 |


\* Artikelnr. 421B: 3-Delige koppeling met vlakke afdichting.

|   | Afmeting                 | Artikelnr.             |
|---|--------------------------|------------------------|
| <b>412</b><br><b>RVS Verloop T-stuk 90°</b><br>- 3 x binnendraad<br> | 1/4" x 1/8" x 1/4"       | 412014018              |
|   | 3/8" x 1/8" x 3/8"       | 412038018              |
|   | 3/8" x 1/4" x 3/8"       | 412038014              |
|   | 1/2" x 1/4" x 1/2"       | 412012014              |
|   | 1/2" x 3/8" x 1/2"       | 412012038              |
|   | 3/4" x 1/2" x 3/4"       | 412034012              |
|   | 1" x 1/2" x 1"           | 412100012              |
|   | 1" x 3/4" x 1"           | 412100034              |
|   | 1 1/4" x 1/2" x 1 1/4"   | 412114012              |
|   | 1 1/4" x 3/4" x 1 1/4"   | 412114034              |
|   | 1 1/4" x 1" x 1 1/4"     | 412114100              |
|   | 1 1/2" x 1/2" x 1 1/2"   | 412112012              |
|   | 1 1/2" x 3/4" x 1 1/2"   | 412112034              |
|   | 1 1/2" x 1" x 1 1/2"     | 412112100              |
|   | 1 1/2" x 1 1/4" x 1 1/2" | 412112114              |
|   | 2" x 1" x 2"             | 412200100              |
| 2" x 1 1/4" x 2"  | 412200114                |                        |
| 2" x 1 1/2" x 2"  | 412200112                |                        |
|   |                          | Artikelgroep: 13.02.05 |

|   | Afmeting | Artikelnr.             |
|---|----------|------------------------|
| <b>423</b><br><b>RVS 3-Delige koppeling</b><br>- binnendraad x buitendraad<br>- conische dichting*<br> | 1/8"     | 423018                 |
|   | 1/4"     | 423014                 |
|   | 3/8"     | 423038                 |
|   | 1/2"     | 423012                 |
|   | 3/4"     | 423034                 |
|   | 1"       | 423100                 |
|   | 1 1/4"   | 423114                 |
|   | 1 1/2"   | 423112                 |
|   | 2"       | 423200                 |
|   | 2 1/2"   | 423212                 |
|   | 3"       | 423300                 |
| 4"  | 423400   |                        |
|   |          | Artikelgroep: 13.02.05 |

\* Artikelnr. 423B: 3-Delige koppeling met vlakke afdichting.

|  | Afmeting | Artikelnr.             |
|--|----------|------------------------|
| <b>422</b><br><b>RVS Kruisstuk 90°</b><br>- 4 x binnendraad<br> | 1/4"     | 422014                 |
|  | 3/8"     | 422038                 |
|  | 1/2"     | 422012                 |
|  | 3/4"     | 422034                 |
|  | 1"       | 422100                 |
|  | 1 1/4"   | 422114                 |
|  | 1 1/2"   | 422112                 |
|  | 2"       | 422200                 |
|  | 2 1/2"   | 422212                 |
|  | 3"       | 422300                 |
| 4"   | 422400   |                        |
|  |          | Artikelgroep: 13.02.05 |

|   | Afmeting      | Artikelnr.             |
|---|---------------|------------------------|
| <b>325</b><br><b>RVS Slangtule</b><br>- met zeskant<br>- met buitendraad<br> | 1/8" x 7      | 325018                 |
|   | 1/4" x 9      | 325014                 |
|   | 3/8" x 8      | 32503808               |
|   | 3/8" x 11     | 325038                 |
|   | 3/8" x 13     | 32503813               |
|   | 1/2" x 13     | 325012                 |
|   | 3/4" x 16     | 325034                 |
|   | 3/4" x 20,5   | 325034205              |
|   | 1" x 25       | 325100                 |
|   | 1 1/4" x 31,8 | 325114318              |
|   | 1 1/4" x 33   | 325114                 |
|   | 1 1/2" x 39   | 325112                 |
|   | 2" x 51       | 325200                 |
| 2" x 57   | 32520057      |                        |
|   |               | Artikelgroep: 13.02.05 |

## RVS Draadfittingen (RVS 316)

**461**  
RVS Moer  
- met binnendraad



| Afmeting | Artikelnr. |
|----------|------------|
| 1/8"     | 461018     |
| 1/4"     | 461014     |
| 3/8"     | 461038     |
| 1/2"     | 461012     |
| 3/4"     | 461034     |
| 1"       | 461100     |
| 1 1/4"   | 461114     |
| 1 1/2"   | 461112     |
| 2"       | 461200     |
| 2 1/2"   | 461212     |
| 3"       | 461300     |
| 4"       | 461400     |

Artikelgroep: 13.02.05

## RVS Lasfittingen (RVS 316)

• Standaard wanddikte is 2mm (waar van toepassing).

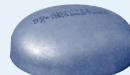
**480**  
RVS Lasbocht 90°  
- 3S



| Afmeting       | Artikelnr. |
|----------------|------------|
| 21,3 (1/2")    | 480213     |
| 26,9 (3/4")    | 480269     |
| 33,7 (1")      | 480337     |
| 42,4 (1 1/4")  | 480424     |
| 48,3 (1 1/2")  | 480483     |
| 60,3 (2")      | 480603     |
| 76,1 (2 1/2")  | 480761     |
| 88,9 (3")      | 480889     |
| 101,6 (3 1/2") | 480901     |
| 114,3 (4")     | 480914     |

Artikelgroep: 13.02.10

**482**  
RVS Laskap



| Afmeting       | Artikelnr. |
|----------------|------------|
| 21,3 (1/2")    | 482213     |
| 26,9 (3/4")    | 482269     |
| 33,7 (1")      | 482337     |
| 42,4 (1 1/4")  | 482424     |
| 48,3 (1 1/2")  | 482483     |
| 60,3 (2")      | 482603     |
| 76,1 (2 1/2")  | 482761     |
| 88,9 (3")      | 482889     |
| 101,6 (3 1/2") | 482901     |
| 114,3 (4")     | 482914     |

Artikelgroep: 13.02.10

**481**  
RVS Lasverloopstuk  
- concentrisch



| Afmeting     | Artikelnr. |
|--------------|------------|
| 33,7 x 21,3  | 481337213  |
| 33,7 x 26,9  | 481337269  |
| 42,4 x 33,7  | 481424337  |
| 48,3 x 21,3  | 481483213  |
| 48,3 x 26,9  | 481483269  |
| 48,3 x 33,7  | 481483337  |
| 48,3 x 42,4  | 481483424  |
| 60,3 x 26,9  | 481603269  |
| 60,3 x 33,7  | 481603337  |
| 60,3 x 42,4  | 481603424  |
| 60,3 x 48,3  | 481603483  |
| 76,1 x 48,3  | 481761483  |
| 76,1 x 60,3  | 481761603  |
| 88,9 x 48,3  | 481889483  |
| 88,9 x 60,3  | 481889603  |
| 88,9 x 76,1  | 481889761  |
| 114,3 x 60,3 | 481914603  |
| 114,3 x 76,1 | 481914761  |
| 114,3 x 88,9 | 481914889  |

Artikelgroep: 13.02.10

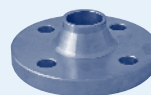
**483**  
RVS Las T-stuk



| Afmeting      | Artikelnr. |
|---------------|------------|
| 21,3 (1/2")   | 483213     |
| 26,9 (3/4")   | 483269     |
| 33,7 (1")     | 483337     |
| 42,4 (1 1/4") | 483424     |
| 48,3 (1 1/2") | 483483     |
| 60,3 (2")     | 483603     |
| 76,1 (2 1/2") | 483761     |
| 88,9 (3")     | 483889     |
| 114,3 (4")    | 483914     |

Artikelgroep: 13.02.10

**484**  
RVS Voorlasflens  
- type nek flens



| Afmeting      | Artikelnr. |
|---------------|------------|
| DN15 (1/2")   | 484015     |
| DN20 (3/4")   | 484020     |
| DN25 (1")     | 484025     |
| DN32 (1 1/4") | 484032     |
| DN40 (1 1/2") | 484040     |
| DN50 (2")     | 484050     |
| DN65 (2 1/2") | 484065     |
| DN80 (3")     | 484080     |
| DN100 (4")    | 484100     |
| DN200 (8")    | 484200     |

Artikelgroep: 13.02.10


Andere afmetingen zijn op aanvraag leverbaar.

# 13.03 Afsluiters voor RVS leidingen

## RVS Kogelkranen (RVS 316)


- Zowel in 1-, 2-, als 3-delige uitvoering uit voorraad leverbaar.
- Met draad- of flensaansluiting.
- Ook leverbaar met elektrische of pneumatische opbouw.

|   | Afmeting | Artikelnr.             |
|---|----------|------------------------|
| <b>101</b>  | 1/4"     | 101014                 |
| <b>RVS Kogelkraan</b>   | 3/8"     | 101038                 |
| <b>1-delig</b>  | 1/2"     | 101012                 |
| - gereduceerde  | 3/4"     | 101034                 |
| doorlaat  | 1"       | 101100                 |
| - 2 x binnendraad   | 1 1/4"   | 101114                 |
|   | 1 1/2"   | 101112                 |
|   | 2"       | 101200                 |
|  |          | Artikelgroep: 13.03.05 |


|   | Afmeting | Artikelnr.             |
|---|----------|------------------------|
| <b>3251</b>   | 1/2"     | 3251012                |
| <b>RVS Kogelkraan</b>   | 3/4"     | 3251034                |
| <b>3-delig</b>  | 1"       | 3251100                |
| - met flenzen   | 1 1/4"   | 3251114                |
| - volle doorlaat  | 1 1/2"   | 3251112                |
|   | 2"       | 3251200                |
|   | 2 1/2"   | 3251212                |
|   | 3"       | 3251300                |
|   | 4"       | 3251400                |
|  |          | Artikelgroep: 13.03.05 |

|   | Afmeting | Artikelnr.             |
|---|----------|------------------------|
| <b>202</b>  | 1/4"     | 202014                 |
| <b>RVS Kogelkraan</b>   | 3/8"     | 202038                 |
| <b>2-delig</b>  | 1/2"     | 202012                 |
| - volle doorlaat  | 3/4"     | 202034                 |
| - 2 x binnendraad   | 1"       | 202100                 |
|   | 1 1/4"   | 202114                 |
|   | 1 1/2"   | 202112                 |
|   | 2"       | 202200                 |
|   | 2 1/2"   | 202212                 |
|   | 3"       | 202300                 |
|   | 4"       | 202400                 |
|  |          | Artikelgroep: 13.03.05 |

## RVS Terugslagkleppen

|  | Afmeting | Artikelnr.             |
|--|----------|------------------------|
| <b>3281</b>  | 1/2"     | 3281012                |
| <b>RVS Terugslagklep</b>   | 3/4"     | 3281034                |
| - 2 x binnendraad  | 1"       | 3281100                |
|  | 1 1/4"   | 3281114                |
|  | 1 1/2"   | 3281112                |
|  | 2"       | 3281200                |
|  |          | Artikelgroep: 13.03.05 |

|   | Afmeting | Artikelnr.             |
|---|----------|------------------------|
| <b>216</b>  | 1/2"     | 216012                 |
| <b>RVS Kogelkraan</b>   | 3/4"     | 216034                 |
| <b>2-delig</b>  | 1"       | 216100                 |
| - met flenzen   | 1 1/4"   | 216114                 |
| - volle doorlaat  | 1 1/2"   | 216112                 |
|   | 2"       | 216200                 |
|   | 2 1/2"   | 216212                 |
|   | 3"       | 216300                 |
|   | 4"       | 216400                 |
|  |          | Artikelgroep: 13.03.05 |

|   | Afmeting | Artikelnr.             |
|---|----------|------------------------|
| <b>3291</b>   | 2"       | 3291200                |
| <b>RVS Balkeerklep</b>  |          | Artikelgroep: 13.03.05 |
|  |          |                        |

|   | Afmeting | Artikelnr.             |
|---|----------|------------------------|
| <b>301</b>  | 1/4"     | 301014                 |
| <b>RVS Kogelkraan</b>   | 3/8"     | 301038                 |
| <b>3-delig</b>  | 1/2"     | 301012                 |
| - volle doorlaat  | 3/4"     | 301034                 |
| - 2 x binnendraad   | 1"       | 301100                 |
|   | 1 1/4"   | 301114                 |
|   | 1 1/2"   | 301112                 |
|   | 2"       | 301200                 |
|   | 2 1/2"   | 301212                 |
|   | 3"       | 301300                 |
|   | 4"       | 301400                 |
|  |          | Artikelgroep: 13.03.05 |
| Artikelnr. 3011: RVS Laseind voor RVS Kogelkraan artikelnr. 301.                    |          |                        |

## RVS Schuifafsluiters (RVS 316)

|   | Afmeting | Artikelnr.             |
|---|----------|------------------------|
| <b>3271</b>   | 1/2"     | 3271012                |
| <b>RVS Schuifafsluiter</b>  | 3/4"     | 3271034                |
| - 2 x binnendraad   | 1"       | 3271100                |
|   | 1 1/4"   | 3271114                |
|   | 1 1/2"   | 3271112                |
|   | 2"       | 3271200                |
|  |          | Artikelgroep: 13.03.05 |

RVS 3-Weg kogelkranen, naaldafsluiters en overige afsluiters zijn op aanvraag leverbaar.

# Productgroep 14

PE Drukleidingen > PVC Drukleidingen > PP Drukleidingen  
> Afstandbediende afsluiters > C-PVC Programma >  
Blue-system programma > Binnen- en buitenriolering  
> Kabelbescherming en telecom > Milieu programma  
> Tanks > Folie en geotextielen > Halffabrikaten >  
RVS Programma > Malleable programma > Sanitair  
en verwarming > Metalen appendages en fittingen >  
Slangen en koppelingen > Pompen, filters en kabel  
> Lijm, reiniger en toebehoren > Bevestigingsmaterialen >  
Machines en gereedschappen

>> Malleable programma

# Milder

— VEELZIJDIG IN LEIDINGSYSTEMEN —



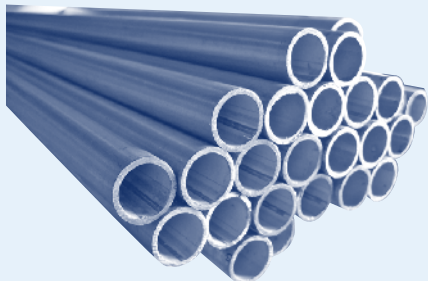
# 14.01 Verzinkte buis

## Verzinkte buis

• Lengten: standaard op 6 meter.

**2500**

**Verzinkte buis**  
- met draad en sok



**Afmeting**

**Artikelnr.**

|        |         |
|--------|---------|
| 3/8"   | 2500038 |
| 1/2"   | 2500012 |
| 3/4"   | 2500034 |
| 1"     | 2500100 |
| 1 1/4" | 2500114 |
| 1 1/2" | 2500112 |
| 2"     | 2500200 |
| 2 1/2" | 2500212 |
| 3"     | 2500300 |
| 4"     | 2500400 |

Artikelgroep: 14.01.05

# 14.02 Malleable fittingen

## Verzinkte fittingen

**Afmeting**

**Artikelnr.**

**1**  
**Verzinkte lange bocht 90°**  
- binnendraad  
x buitendraad



|        |       |
|--------|-------|
| 1/8"   | G1018 |
| 1/4"   | G1014 |
| 3/8"   | G1038 |
| 1/2"   | G1012 |
| 3/4"   | G1034 |
| 1"     | G1100 |
| 1 1/4" | G1114 |
| 1 1/2" | G1112 |
| 2"     | G1200 |
| 2 1/2" | G1212 |
| 3"     | G1300 |
| 4"     | G1400 |

Artikelgroep: 14.02.05

**Afmeting**

**Artikelnr.**

**3**  
**Verzinkte lange bocht 90°**  
- 2 x buitendraad



|        |       |
|--------|-------|
| 3/8"   | G3038 |
| 1/2"   | G3012 |
| 3/4"   | G3034 |
| 1"     | G3100 |
| 1 1/4" | G3114 |
| 1 1/2" | G3112 |
| 2"     | G3200 |

Artikelgroep: 14.02.05

**Afmeting**

**Artikelnr.**

**2**  
**Verzinkte lange bocht 90°**  
- 2 x binnendraad



|        |       |
|--------|-------|
| 1/4"   | G2014 |
| 3/8"   | G2038 |
| 1/2"   | G2012 |
| 3/4"   | G2034 |
| 1"     | G2100 |
| 1 1/4" | G2114 |
| 1 1/2" | G2112 |
| 2"     | G2200 |
| 2 1/2" | G2212 |
| 3"     | G2300 |
| 4"     | G2400 |

Artikelgroep: 14.02.05

**Afmeting**

**Artikelnr.**

**40**  
**Verzinkte bocht 45°**  
- binnendraad  
x buitendraad



|        |        |
|--------|--------|
| 1/4"   | G40014 |
| 3/8"   | G40038 |
| 1/2"   | G40012 |
| 3/4"   | G40034 |
| 1"     | G40100 |
| 1 1/4" | G40114 |
| 1 1/2" | G40112 |
| 2"     | G40200 |
| 2 1/2" | G40212 |
| 3"     | G40300 |
| 4"     | G40400 |

Artikelgroep: 14.02.05

## Verzinkte fittingen

|  | Afmeting | Artikelnr. |
|--|----------|------------|
| <b>41</b><br><b>Verzinkte bocht 45°</b><br>- 2 x binnendraad | 1/4"     | G41014     |
|  | 3/8"     | G41038     |
|  | 1/2"     | G41012     |
|  | 3/4"     | G41034     |
|  | 1"       | G41100     |
|  | 1 1/4"   | G41114     |
|  | 1 1/2"   | G41112     |
|  | 2"       | G41200     |
|  | 2 1/2"   | G41212     |
|  | 3"       | G41300     |
|  | 4"       | G41400     |
| Artikelgroep: 14.02.05                                       |          |            |



|  | Afmeting               | Artikelnr. |
|--|------------------------|------------|
| <b>92</b><br><b>Verzinkte verloopknie 90°</b><br>- binnendraad x buitendraad | 1/2" x 3/8"            | G92012038  |
|  | 3/4" x 1/2"            | G92034012  |
|  | 1" x 3/4"              | G92100034  |
|  | Artikelgroep: 14.02.05 |            |



|   | Afmeting | Artikelnr. |
|---|----------|------------|
| <b>90</b><br><b>Verzinkte knie 90°</b><br>- 2 x binnendraad | 1/8"     | G90018     |
|   | 1/4"     | G90014     |
|   | 3/8"     | G90038     |
|   | 1/2"     | G90012     |
|   | 3/4"     | G90034     |
|   | 1"       | G90100     |
|   | 1 1/4"   | G90114     |
|   | 1 1/2"   | G90112     |
|   | 2"       | G90200     |
|   | 2 1/2"   | G90212     |
|   | 3"       | G90300     |
| 4"  | G90400   |            |
| Artikelgroep: 14.02.05                                      |          |            |



|   | Afmeting               | Artikelnr. |
|---|------------------------|------------|
| <b>96</b><br><b>Verzinkte 3-delige haakse koppeling</b><br>- conisch<br>- 2 x binnendraad | 1/4"                   | G96014     |
|   | 3/8"                   | G96038     |
|   | 1/2"                   | G96012     |
|   | 3/4"                   | G96034     |
|   | 1"                     | G96100     |
|   | 1 1/4"                 | G96114     |
|   | 1 1/2"                 | G96112     |
|   | 2"                     | G96200     |
|   | 2 1/2"                 | G96212     |
|   | Artikelgroep: 14.02.05 |            |



|  | Afmeting               | Artikelnr. |  |
|--|------------------------|------------|--|
| <b>90</b><br><b>Verzinkte verloopknie 90°</b><br>- 2 x binnendraad | 3/8" x 1/4"            | G90038014  |  |
|  | 1/2" x 3/8"            | G90012038  |  |
|  | 3/4" x 3/8"            | G90034038  |  |
|  | 3/4" x 1/2"            | G90034012  |  |
|  | 1" x 1/2"              | G90100012  |  |
|  | 1" x 3/4"              | G90100034  |  |
|  | 1 1/4" x 3/4"          | G90114034  |  |
|  | 1 1/4" x 1"            | G90114100  |  |
|  | 1 1/2" x 3/4"          | G90112034  |  |
|  | 1 1/2" x 1"            | G90112100  |  |
|  | 1 1/2" x 1 1/4"        | G90112114  |  |
|  | 2" x 1"                | G90200100  |  |
|  | 2" x 1 1/4"            | G90200114  |  |
|  | 2" x 1 1/2"            | G90200112  |  |
|  | 2 1/2" x 2"            | G90212200  |  |
|  | Artikelgroep: 14.02.05 |            |  |



|   | Afmeting | Artikelnr. |
|---|----------|------------|
| <b>98</b><br><b>Verzinkte 3-delige haakse koppeling</b><br>- conisch<br>- binnendraad x buitendraad | 1/4"     | G98014     |
|   | 3/8"     | G98038     |
|   | 1/2"     | G98012     |
|   | 3/4"     | G98034     |
|   | 1"       | G98100     |
|   | 1 1/4"   | G98114     |
|   | 1 1/2"   | G98112     |
|   | 2"       | G98200     |
| 2 1/2"  | G98212   |            |
| Artikelgroep: 14.02.05  |          |            |



|   | Afmeting | Artikelnr. |
|---|----------|------------|
| <b>92</b><br><b>Verzinkte knie 90°</b><br>- binnendraad x buitendraad | 1/8"     | G92018     |
|   | 1/4"     | G92014     |
|   | 3/8"     | G92038     |
|   | 1/2"     | G92012     |
|   | 3/4"     | G92034     |
|   | 1"       | G92100     |
|   | 1 1/4"   | G92114     |
|   | 1 1/2"   | G92112     |
|   | 2"       | G92200     |
|   | 2 1/2"   | G92212     |
|   | 3"       | G92300     |
| 4"  | G92400   |            |
| Artikelgroep: 14.02.05  |          |            |



|   | Afmeting | Artikelnr. |
|---|----------|------------|
| <b>130</b><br><b>Verzinkt T-stuk 90°</b><br>- 3 x binnendraad | 1/8"     | G130018    |
|   | 1/4"     | G130014    |
|   | 3/8"     | G130038    |
|   | 1/2"     | G130012    |
|   | 3/4"     | G130034    |
|   | 1"       | G130100    |
|   | 1 1/4"   | G130114    |
|   | 1 1/2"   | G130112    |
|   | 2"       | G130200    |
|   | 2 1/2"   | G130212    |
|   | 3"       | G130300    |
| 4"  | G130400  |            |
| Artikelgroep: 14.02.05  |          |            |



# 14.02 Malleable fittingen

## Verzinkte fittingen

### 130

Verzinkt verloop  
T-stuk 90°  
- 3 x binnendraad



| Afmeting                 | Artikelnr.    |
|--------------------------|---------------|
| 3/8" x 1/2" x 3/8"       | G130038012    |
| 1/2" x 3/8" x 3/8"       | G130012038038 |
| 1/2" x 3/8" x 1/2"       | G130012038    |
| 1/2" x 1/2" x 3/8"       | G130012012038 |
| 1/2" x 3/4" x 1/2"       | G130012034    |
| 3/4" x 3/8" x 3/4"       | G130034038    |
| 3/4" x 1/2" x 1/2"       | G130034012012 |
| 3/4" x 1/2" x 3/4"       | G130034012    |
| 3/4" x 3/4" x 3/8"       | G130034034038 |
| 3/4" x 3/4" x 1/2"       | G130034034012 |
| 3/4" x 1" x 1/2"         | G130034100012 |
| 3/4" x 1" x 3/4"         | G130034100    |
| 1" x 3/8" x 1"           | G130100038    |
| 1" x 1/2" x 1/2"         | G130100012012 |
| 1" x 1/2" x 3/4"         | G130100012034 |
| 1" x 1/2" x 1"           | G130100012    |
| 1" x 3/4" x 1/2"         | G130100034012 |
| 1" x 3/4" x 3/4"         | G130100034034 |
| 1" x 3/4" x 1"           | G130100034    |
| 1" x 1" x 1/2"           | G130100100012 |
| 1" x 1" x 3/4"           | G130100100034 |
| 1" x 1 1/4" x 3/4"       | G130100114034 |
| 1" x 1 1/4" x 1"         | G130100114    |
| 1" x 1 1/2" x 1"         | G130100112    |
| 1 1/4" x 3/8" x 1 1/4"   | G130114038    |
| 1 1/4" x 1/2" x 1"       | G130114012100 |
| 1 1/4" x 1/2" x 1 1/4"   | G130114012    |
| 1 1/4" x 3/4" x 1"       | G130114034100 |
| 1 1/4" x 3/4" x 1 1/4"   | G130114034    |
| 1 1/4" x 1" x 3/4"       | G130114100034 |
| 1 1/4" x 1" x 1"         | G130114100100 |
| 1 1/4" x 1" x 1 1/4"     | G130114100    |
| 1 1/4" x 1 1/4" x 1/2"   | G130114114012 |
| 1 1/4" x 1 1/4" x 3/4"   | G130114114034 |
| 1 1/4" x 1 1/4" x 1"     | G130114114100 |
| 1 1/4" x 1 1/2" x 1 1/4" | G130114112    |
| 1 1/2" x 1/2" x 1 1/2"   | G130112012    |
| 1 1/2" x 3/4" x 1 1/4"   | G130112034114 |
| 1 1/2" x 3/4" x 1 1/2"   | G130112034    |
| 1 1/2" x 1" x 1"         | G130112100100 |
| 1 1/2" x 1" x 1 1/4"     | G130112100114 |
| 1 1/2" x 1" x 1 1/2"     | G130112100    |
| 1 1/2" x 1 1/4" x 1 1/4" | G130112114114 |
| 1 1/2" x 1 1/4" x 1 1/2" | G130112114    |
| 1 1/2" x 1 1/2" x 1 1/2" | G130112112012 |
| 1 1/2" x 1 1/2" x 1"     | G130112112100 |
| 1 1/2" x 1 1/2" x 1 1/4" | G130112112114 |
| 1 1/2" x 2" x 1 1/2"     | G130112200    |
| 2" x 1/2" x 2"           | G130200012    |
| 2" x 3/4" x 2"           | G130200034    |
| 2" x 1" x 2"             | G130200100    |
| 2" x 1 1/4" x 2"         | G130200114    |
| 2" x 1 1/2" x 2"         | G130200112    |
| 2 1/2" x 1" x 2 1/2"     | G130212100    |
| 2 1/2" x 1 1/2" x 2 1/2" | G130212112    |
| 2 1/2" x 2" x 2 1/2"     | G130212200    |
| 3" x 1" x 3"             | G130300100    |
| 3" x 1 1/2" x 3"         | G130300112    |
| 3" x 2" x 3"             | G130300200    |
| 3" x 2 1/2" x 3"         | G130300212    |

Artikelgroep: 14.02.05

### 180

Verzinkt  
kruisstuk 90°  
- 4 x binnendraad



| Afmeting | Artikelnr. |
|----------|------------|
| 1/4"     | G180014    |
| 3/8"     | G180038    |
| 1/2"     | G180012    |
| 3/4"     | G180034    |
| 1"       | G180100    |
| 1 1/4"   | G180114    |
| 1 1/2"   | G180112    |
| 2"       | G180200    |
| 2 1/2"   | G180212    |
| 3"       | G180300    |

Artikelgroep: 14.02.05

| Afmeting | Artikelnr. |
|----------|------------|
|----------|------------|

### 240

Verzinkte  
verloopsok  
- 2 x binnendraad



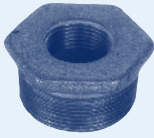
|                 |            |
|-----------------|------------|
| 1/4" x 1/8"     | G240014018 |
| 3/8" x 1/4"     | G240038014 |
| 1/2" x 1/4"     | G240012014 |
| 1/2" x 3/8"     | G240012038 |
| 3/4" x 1/4"     | G240034014 |
| 3/4" x 3/8"     | G240034038 |
| 3/4" x 1/2"     | G240034012 |
| 1" x 3/8"       | G240100038 |
| 1" x 1/2"       | G240100012 |
| 1" x 3/4"       | G240100034 |
| 1 1/4" x 1/2"   | G240114012 |
| 1 1/4" x 3/4"   | G240114034 |
| 1 1/4" x 1"     | G240114100 |
| 1 1/2" x 1/2"   | G240112012 |
| 1 1/2" x 3/4"   | G240112034 |
| 1 1/2" x 1"     | G240112100 |
| 1 1/2" x 1 1/4" | G240112114 |
| 2" x 1/2"       | G240200012 |
| 2" x 3/4"       | G240200034 |
| 2" x 1"         | G240200100 |
| 2" x 1 1/4"     | G240200114 |
| 2" x 1 1/2"     | G240200112 |
| 2 1/2" x 1 1/4" | G240212114 |
| 2 1/2" x 1 1/2" | G240212112 |
| 2 1/2" x 2"     | G240212200 |
| 3" x 1 1/2"     | G240300112 |
| 3" x 2"         | G240300200 |
| 3" x 2 1/2"     | G240300212 |
| 4" x 2"         | G240400200 |
| 4" x 2 1/2"     | G240400212 |
| 4" x 3"         | G240400300 |

Artikelgroep: 14.02.05

## Verzinkte fittingen

|  | Afmeting        | Artikelnr. |
|--|-----------------|------------|
| <b>241</b><br><b>Verzinkte verloopring</b><br>- buitendraad<br>x binnendraad | 1/4" x 1/8"     | G241014018 |
|  | 3/8" x 1/8"     | G241038018 |
|  | 3/8" x 1/4"     | G241038014 |
|  | 1/2" x 1/8"     | G241012018 |
|  | 1/2" x 1/4"     | G241012014 |
|  | 1/2" x 3/8"     | G241012038 |
|  | 3/4" x 1/4"     | G241034014 |
|  | 3/4" x 1/8"     | G241034018 |
|  | 3/4" x 3/8"     | G241034038 |
|  | 3/4" x 1/2"     | G241034012 |
|  | 1" x 1/4"       | G241100014 |
|  | 1" x 3/8"       | G241100038 |
|  | 1" x 1/2"       | G241100012 |
|  | 1" x 3/4"       | G241100034 |
|  | 1 1/4" x 3/8"   | G241114038 |
|  | 1 1/4" x 1/2"   | G241114012 |
|  | 1 1/4" x 3/4"   | G241114034 |
|  | 1 1/4" x 1"     | G241114100 |
|  | 1 1/2" x 3/8"   | G241112038 |
|  | 1 1/2" x 1/2"   | G241112012 |
|  | 1 1/2" x 3/4"   | G241112034 |
|  | 1 1/2" x 1"     | G241112100 |
|  | 1 1/2" x 1 1/4" | G241112114 |
|  | 2" x 1/2"       | G241200012 |
|  | 2" x 3/4"       | G241200034 |
|  | 2" x 1"         | G241200100 |
|  | 2" x 1 1/4"     | G241200114 |
|  | 2" x 1 1/2"     | G241200112 |
|  | 2 1/2" x 1"     | G241212100 |
|  | 2 1/2" x 1 1/4" | G241212114 |
|  | 2 1/2" x 1 1/2" | G241212112 |
|  | 2 1/2" x 2"     | G241212200 |
|  | 3" x 1"         | G241300100 |
|  | 3" x 1 1/4"     | G241300114 |
|  | 3" x 1 1/2"     | G241300112 |
|  | 3" x 2"         | G241300200 |
|  | 3" x 2 1/2"     | G241300212 |
|  | 4" x 2"         | G241400200 |
|  | 4" x 2 1/2"     | G241400212 |
|  | 4" x 3"         | G241400300 |
| 5" x 4"  | G241500400      |            |

Artikelgroep: 14.02.05



|   | Afmeting        | Artikelnr. |
|---|-----------------|------------|
| <b>246</b><br><b>Verzinkte verloopsoknippel</b><br>- binnendraad<br>x buitendraad | 1/4" x 1/8"     | G246014018 |
|   | 3/8" x 1/4"     | G246038014 |
|   | 1/2" x 1/4"     | G246012014 |
|   | 1/2" x 3/8"     | G246012038 |
|   | 3/4" x 3/8"     | G246034038 |
|   | 3/4" x 1/2"     | G246034012 |
|   | 1" x 3/8"       | G246100038 |
|   | 1" x 1/2"       | G246100012 |
|   | 1" x 3/4"       | G246100034 |
|   | 1 1/4" x 1/2"   | G246114012 |
|   | 1 1/4" x 3/4"   | G246114034 |
|   | 1 1/4" x 1"     | G246114100 |
|   | 1 1/2" x 3/4"   | G246112034 |
|   | 1 1/2" x 1"     | G246112100 |
|   | 1 1/2" x 1 1/4" | G246112114 |
|   | 2" x 1"         | G246200100 |
|   | 2" x 1 1/4"     | G246200114 |
|   | 2" x 1 1/2"     | G246200112 |
|   | 2 1/2" x 2"     | G246212200 |
|   | 3" x 2"         | G246300200 |
| 3" x 2 1/2"   | G246300212      |            |

Artikelgroep: 14.02.05

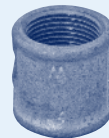


|  | Afmeting | Artikelnr.             |
|--|----------|------------------------|
| <b>221</b><br><b>Verzinkte knie</b><br>- met zijspruit | 3/8"     | G221038                |
|  | 1/2"     | G221012                |
|  | 3/4"     | G221034                |
|  | 1"       | G221100                |
|  |          | Artikelgroep: 14.02.05 |

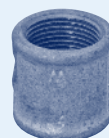


|  | Afmeting | Artikelnr. |
|--|----------|------------|
| <b>270</b><br><b>Verzinkte ronde sok</b><br>- egaal<br>- 2 x binnendraad | 1/8"     | G270018    |
|  | 1/4"     | G270014    |
|  | 3/8"     | G270038    |
|  | 1/2"     | G270012    |
|  | 3/4"     | G270034    |
|  | 1"       | G270100    |
|  | 1 1/4"   | G270114    |
|  | 1 1/2"   | G270112    |
|  | 2"       | G270200    |
|  | 2 1/2"   | G270212    |
|  | 3"       | G270300    |
|  | 4"       | G270400    |
| 5"   | G270500  |            |

Artikelgroep: 14.02.05



|   | Afmeting | Artikelnr.             |
|---|----------|------------------------|
| <b>271</b><br><b>Verzinkte ronde sok</b><br>- linkse draad<br>x rechtse draad | 3/8"     | G271038                |
|   | 1/2"     | G271012                |
|   | 3/4"     | G271034                |
|   | 1"       | G271100                |
|   | 1 1/4"   | G271114                |
|   | 1 1/2"   | G271112                |
|   | 2"       | G271200                |
|   |          | Artikelgroep: 14.02.05 |



|   | Afmeting        | Artikelnr. |
|---|-----------------|------------|
| <b>245</b><br><b>Verzinkte verloopnippel</b><br>- 2 x buitendraad | 1/4" x 1/8"     | G245014018 |
|   | 3/8" x 1/8"     | G245038018 |
|   | 3/8" x 1/4"     | G245038014 |
|   | 1/2" x 1/4"     | G245012014 |
|   | 1/2" x 3/8"     | G245012038 |
|   | 3/4" x 3/8"     | G245034038 |
|   | 3/4" x 1/2"     | G245034012 |
|   | 1" x 1/2"       | G245100012 |
|   | 1" x 3/4"       | G245100034 |
|   | 1 1/4" x 1/2"   | G245114012 |
|   | 1 1/4" x 3/4"   | G245114034 |
|   | 1 1/4" x 1"     | G245114100 |
|   | 1 1/2" x 3/4"   | G245112034 |
|   | 1 1/2" x 1"     | G245112100 |
|   | 1 1/2" x 1 1/4" | G245112114 |
|   | 2" x 1"         | G245200100 |
|   | 2" x 1 1/4"     | G245200114 |
|   | 2" x 1 1/2"     | G245200112 |
|   | 2 1/2" x 1 1/2" | G245212112 |
|   | 2 1/2" x 2"     | G245212200 |
| 3" x 2"   | G245300200      |            |
| 3" x 2 1/2"   | G245300212      |            |
| 4" x 3"   | G245400300      |            |

Artikelgroep: 14.02.05



# 14.02 Malleable fittingen

## Verzinkte fittingen

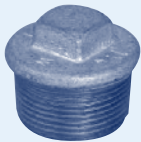
|   | Afmeting | Artikelnr. |
|---|----------|------------|
| <b>280</b><br>Verzinkte dubbele<br>nippel<br>- egaal<br>- 2 x buitendraad | 1/8"     | G280018    |
|   | 1/4"     | G280014    |
|   | 3/8"     | G280038    |
|   | 1/2"     | G280012    |
|   | 3/4"     | G280034    |
|   | 1"       | G280100    |
|   | 1 1/4"   | G280114    |
|   | 1 1/2"   | G280112    |
|   | 2"       | G280200    |
|   | 2 1/2"   | G280212    |
|   | 3"       | G280300    |
|   | 4"       | G280400    |

Artikelgroep: 14.02.05



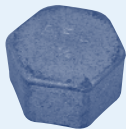
|  | Afmeting | Artikelnr. |
|--|----------|------------|
| <b>290</b><br>Verzinkte plug<br>- buitendraad<br>- met rand en<br>vierkant | 1/8"     | G290018    |
|  | 1/4"     | G290014    |
|  | 3/8"     | G290038    |
|  | 1/2"     | G290012    |
|  | 3/4"     | G290034    |
|  | 1"       | G290100    |
|  | 1 1/4"   | G290114    |
|  | 1 1/2"   | G290112    |
|  | 2"       | G290200    |
|  | 2 1/2"   | G290212    |
|  | 3"       | G290300    |
|  | 4"       | G290400    |

Artikelgroep: 14.02.05



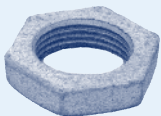
|  | Afmeting | Artikelnr. |
|--|----------|------------|
| <b>300</b><br>Verzinkte kap<br>- met zeskant | 1/8"     | G300018    |
|  | 1/4"     | G300014    |
|  | 3/8"     | G300038    |
|  | 1/2"     | G300012    |
|  | 3/4"     | G300034    |
|  | 1"       | G300100    |
|  | 1 1/4"   | G300114    |
|  | 1 1/2"   | G300112    |
|  | 2"       | G300200    |
|  | 2 1/2"   | G300212    |
|  | 3"       | G300300    |
|  | 4"       | G300400    |

Artikelgroep: 14.02.05



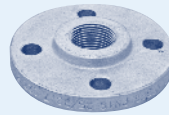
|                                   | Afmeting | Artikelnr. |
|-----------------------------------|----------|------------|
| <b>310</b><br>Verzinkte sluitmoer | 1/4"     | G310014    |
|                                   | 3/8"     | G310038    |
|                                   | 1/2"     | G310012    |
|                                   | 3/4"     | G310034    |
|                                   | 1"       | G310100    |
|                                   | 1 1/4"   | G310114    |
|                                   | 1 1/2"   | G310112    |
|                                   | 2"       | G310200    |
| 2 1/2"                            | G310212  |            |

Artikelgroep: 14.02.05



|  | Afmeting | DN  | Artikelnr. |
|--|----------|-----|------------|
| <b>329</b><br>Verzinkte geboorde<br>flens<br>- binnendraad | 3/4"     | 20  | G329034    |
|  | 1"       | 25  | G329100    |
|  | 1 1/4"   | 32  | G329114    |
|  | 1 1/2"   | 40  | G329112    |
|  | 2"       | 50  | G329200    |
|  | 2 1/2"   | 65  | G329212    |
|  | 3"       | 80  | G329300    |
|  | 4"       | 100 | G329400    |

Artikelgroep: 14.02.05



|   | Afmeting | Artikelnr. |
|---|----------|------------|
| <b>340</b><br>Verzinkte 3-delige<br>koppeling<br>- conisch<br>- 2 x binnendraad | 1/4"     | G340014    |
|   | 3/8"     | G340038    |
|   | 1/2"     | G340012    |
|   | 3/4"     | G340034    |
|   | 1"       | G340100    |
|   | 1 1/4"   | G340114    |
|   | 1 1/2"   | G340112    |
|   | 2"       | G340200    |
|   | 2 1/2"   | G340212    |
|   | 3"       | G340300    |
|   | 4"       | G340400    |

Artikelgroep: 14.02.05



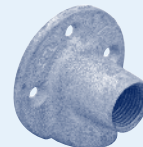
|  | Afmeting | Artikelnr. |
|--|----------|------------|
| <b>341</b><br>Verzinkte 3-delige<br>koppeling<br>- conisch<br>- binnendraad<br>x buitendraad | 1/4"     | G341014    |
|  | 3/8"     | G341038    |
|  | 1/2"     | G341012    |
|  | 3/4"     | G341034    |
|  | 1"       | G341100    |
|  | 1 1/4"   | G341114    |
|  | 1 1/2"   | G341112    |
|  | 2"       | G341200    |
|  | 2 1/2"   | G341212    |
|  | 3"       | G341300    |
|  | 4"       | G341400    |

Artikelgroep: 14.02.05



|                                      | Afmeting | Artikelnr. |
|--------------------------------------|----------|------------|
| <b>471</b><br>Verzinkte<br>muurplaat | 3/8"     | G471038    |
|                                      | 1/2"     | G471012    |
|                                      | 3/4"     | G471034    |

Artikelgroep: 14.02.05



Voor RVS muurplaat 1" zie blz. 204, artikelnr. 465.

|   | Afmeting | Artikelnr. |
|---|----------|------------|
| <b>529</b><br>Verzinkte soknippel<br>- binnendraad<br>x buitendraad | 3/8"     | G529038    |
|   | 1/2"     | G529012    |
|   | 3/4"     | G529034    |
|   | 1"       | G529100    |
|   | 1 1/4"   | G529114    |
|   | 1 1/2"   | G529112    |
|   | 2"       | G529200    |

Artikelgroep: 14.02.05



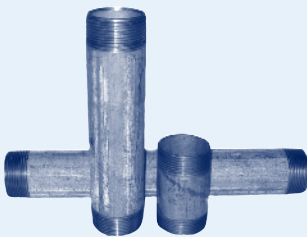
## Verzinkte en zwarte fittingen

|                     | Afmeting          | Artikelnr. verzinkt    | Artikelnr. zwart       |
|---------------------|-------------------|------------------------|------------------------|
| <b>16</b><br>Lassok | $\frac{1}{8}''$   | G16018                 | Z16018                 |
|                     | $\frac{1}{4}''$   | G16014                 | Z16014                 |
|                     | $\frac{3}{8}''$   | G16038                 | Z16038                 |
|                     | $\frac{1}{2}''$   | G16012                 | Z16012                 |
|                     | $\frac{3}{4}''$   | G16034                 | Z16034                 |
|                     | 1''               | G16100                 | Z16100                 |
|                     | 1 $\frac{1}{4}''$ | G16114                 | Z16114                 |
|                     | 1 $\frac{1}{2}''$ | G16112                 | Z16112                 |
|                     | 2''               | G16200                 | Z16200                 |
|                     | 2 $\frac{1}{2}''$ | G16212                 | Z16212                 |
|                     | 3''               | G16300                 | Z16300                 |
|                     | 4''               | G16400                 | Z16400                 |
|                     |                   | Artikelgroep: 14.02.05 | Artikelgroep: 14.02.10 |



## Verzinkte en zwarte pijpnippels

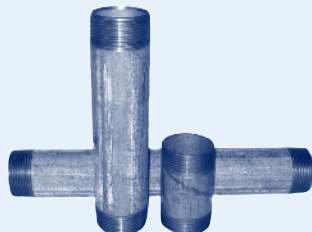
|                         | Afmeting                | Artikelnr. verzinkt | Artikelnr. zwart |
|-------------------------|-------------------------|---------------------|------------------|
| <b>23</b><br>Pijpnippel | $\frac{1}{8}''$ x 40    | G23018040           |                  |
|                         | $\frac{1}{8}''$ x 100   | G23018100           |                  |
|                         | $\frac{1}{4}''$ x 40    | G23014040           | Z23014040        |
|                         | $\frac{1}{4}''$ x 60    | G23014060           | Z23014060        |
|                         | $\frac{1}{4}''$ x 80    | G23014080           | Z23014080        |
|                         | $\frac{1}{4}''$ x 100   | G23014100           | Z23014100        |
|                         | $\frac{1}{4}''$ x 120   | G23014120           | Z23014120        |
|                         | $\frac{1}{4}''$ x 150   | G23014150           | Z23014150        |
|                         | $\frac{1}{4}''$ x 180   | G23014180           | Z23014180        |
|                         | $\frac{1}{4}''$ x 200   | G23014200           | Z23014200        |
|                         | $\frac{1}{4}''$ x 250   | G23014250           | Z23014250        |
|                         | $\frac{1}{4}''$ x 300   | G23014300           | Z23014300        |
|                         | $\frac{3}{8}''$ x 40    | G23038040           | Z23038040        |
|                         | $\frac{3}{8}''$ x 60    | G23038060           | Z23038060        |
|                         | $\frac{3}{8}''$ x 80    | G23038080           | Z23038080        |
|                         | $\frac{3}{8}''$ x 100   | G23038100           | Z23038100        |
|                         | $\frac{3}{8}''$ x 120   | G23038120           | Z23038120        |
|                         | $\frac{3}{8}''$ x 150   | G23038150           | Z23038150        |
|                         | $\frac{3}{8}''$ x 180   | G23038180           | Z23038180        |
|                         | $\frac{3}{8}''$ x 200   | G23038200           | Z23038200        |
|                         | $\frac{3}{8}''$ x 250   | G23038250           | Z23038250        |
|                         | $\frac{3}{8}''$ x 300   | G23038300           | Z23038300        |
|                         | $\frac{1}{2}''$ x 40    | G23012040           | Z23012040        |
|                         | $\frac{1}{2}''$ x 50    | G23012050           |                  |
|                         | $\frac{1}{2}''$ x 60    | G23012060           | Z23012060        |
|                         | $\frac{1}{2}''$ x 80    | G23012080           | Z23012080        |
|                         | $\frac{1}{2}''$ x 100   | G23012100           | Z23012100        |
|                         | $\frac{1}{2}''$ x 120   | G23012120           | Z23012120        |
|                         | $\frac{1}{2}''$ x 150   | G23012150           | Z23012150        |
|                         | $\frac{1}{2}''$ x 180   | G23012180           | Z23012180        |
|                         | $\frac{1}{2}''$ x 200   | G23012200           | Z23012200        |
|                         | $\frac{1}{2}''$ x 250   | G23012250           | Z23012250        |
|                         | $\frac{1}{2}''$ x 300   | G23012300           | Z23012300        |
|                         | $\frac{3}{4}''$ x 40    | G23034040           | Z23034040        |
|                         | $\frac{3}{4}''$ x 60    | G23034060           | Z23034060        |
|                         | $\frac{3}{4}''$ x 80    | G23034080           | Z23034080        |
|                         | $\frac{3}{4}''$ x 100   | G23034100           | Z23034100        |
|                         | $\frac{3}{4}''$ x 120   | G23034120           | Z23034120        |
|                         | $\frac{3}{4}''$ x 150   | G23034150           | Z23034150        |
|                         | $\frac{3}{4}''$ x 180   | G23034180           | Z23034180        |
|                         | $\frac{3}{4}''$ x 200   | G23034200           | Z23034200        |
|                         | $\frac{3}{4}''$ x 250   | G23034250           | Z23034250        |
|                         | $\frac{3}{4}''$ x 300 → | G23034300 →         | Z23034300 →      |



# 14.02 Malleable fittingen

## Verzinkte en zwarte pijpnippels

### Vervolg 23 Pijpnippel



| Afmeting     | Artikelnr. verzinkt | Artikelnr. zwart |
|--------------|---------------------|------------------|
| 1" x 40      | G23100040           | Z23100040        |
| 1" x 60      | G23100060           | Z23100060        |
| 1" x 80      | G23100080           | Z23100080        |
| 1" x 100     | G23100100           | Z23100100        |
| 1" x 120     | G23100120           | Z23100120        |
| 1" x 150     | G23100150           | Z23100150        |
| 1" x 180     | G23100180           | Z23100180        |
| 1" x 200     | G23100200           | Z23100200        |
| 1" x 250     | G23100250           | Z23100250        |
| 1" x 300     | G23100300           | Z23100300        |
| 1 1/4" x 40  | G23114040           | Z23114040        |
| 1 1/4" x 60  | G23114060           | Z23114060        |
| 1 1/4" x 80  | G23114080           | Z23114080        |
| 1 1/4" x 100 | G23114100           | Z23114100        |
| 1 1/4" x 120 | G23114120           | Z23114120        |
| 1 1/4" x 150 | G23114150           | Z23114150        |
| 1 1/4" x 180 | G23114180           | Z23114180        |
| 1 1/4" x 200 | G23114200           | Z23114200        |
| 1 1/4" x 250 | G23114250           | Z23114250        |
| 1 1/4" x 300 | G23114300           | Z23114300        |
| 1 1/2" x 40  | G23112040           | Z23112040        |
| 1 1/2" x 60  | G23112060           | Z23112060        |
| 1 1/2" x 80  | G23112080           | Z23112080        |
| 1 1/2" x 100 | G23112100           | Z23112100        |
| 1 1/2" x 120 | G23112120           | Z23112120        |
| 1 1/2" x 150 | G23112150           | Z23112150        |
| 1 1/2" x 180 | G23112180           | Z23112180        |
| 1 1/2" x 200 | G23112200           | Z23112200        |
| 1 1/2" x 250 | G23112250           | Z23112250        |
| 1 1/2" x 300 | G23112300           | Z23112300        |
| 2" x 40      | G23200040           |                  |
| 2" x 60      | G23200060           | Z23200060        |
| 2" x 80      | G23200080           | Z23200080        |
| 2" x 100     | G23200100           | Z23200100        |
| 2" x 120     | G23200120           | Z23200120        |
| 2" x 150     | G23200150           | Z23200150        |
| 2" x 180     | G23200180           | Z23200180        |
| 2" x 200     | G23200200           | Z23200200        |
| 2" x 250     | G23200250           | Z23200250        |
| 2" x 300     | G23200300           | Z23200300        |
| 2 1/2" x 100 | G23212100           | Z23212100        |
| 2 1/2" x 120 | G23212120           | Z23212120        |
| 2 1/2" x 150 | G23212150           | Z23212150        |
| 2 1/2" x 180 | G23212180           | Z23212180        |
| 2 1/2" x 200 | G23212200           | Z23212200        |
| 2 1/2" x 250 | G23212250           | Z23212250        |
| 2 1/2" x 300 | G23212300           | Z23212300        |
| 3" x 100     | G23300100           | Z23300100        |
| 3" x 120     | G23300120           | Z23300120        |
| 3" x 150     | G23300150           | Z23300150        |
| 3" x 200     | G23300200           | Z23300200        |
| 3" x 250     | G23300250           | Z23300250        |
| 3" x 300     | G23300300           | Z23300300        |
| 4" x 100     | G23400100           | Z23400100        |
| 4" x 120     | G23400120           | Z23400120        |
| 4" x 150     | G23400150           | Z23400150        |
| 4" x 200     | G23400200           | Z23400200        |
| 4" x 250     | G23400250           | Z23400250        |
| 4" x 300     | G23400300           | Z23400300        |
| 4" x 400     | G23400400           |                  |

Artikelgroep: 14.02.15

Artikelgroep: 14.02.20

## Stalen lasbochten

|   | Afmeting      | Artikelnr. |
|---|---------------|------------|
| <b>2400</b>   | 21,3 (1/2")   | 24000213   |
| <b>Stalen lasbocht 90°</b>  | 26,9 (3/4")   | 24000269   |
| - 3S  | 31,8          | 24000318   |
|  | 33,7 (1")     | 24000337   |
|   | 38            | 24000380   |
|   | 42,4 (1 1/4") | 24000424   |
|   | 48,3 (1 1/2") | 24000483   |
|   | 51            | 24000510   |
|   | 57            | 24000570   |
|   | 60,3 (2")     | 24000603   |
|   | 63,5          | 24000635   |
|   | 70            | 24000700   |
|   | 76,1 (2 1/2") | 24000761   |
|   | 82,5          | 24000825   |
|   | 88,9 (3")     | 24000889   |
|   | 95            | 24000950   |
|   | 101,6         | 24001016   |
|   | 108           | 24001080   |
|   | 114,3 (4")    | 24001143   |
|   | 133           | 24001330   |
|   | 139,7         | 24001397   |
|   | 152,4         | 24001524   |
|   | 159           | 24001590   |

Artikelgroep: 14.02.25

## Verzinkte trekvraste fittingen

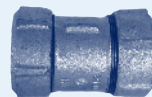
|                                       | Afmeting | Artikelnr. |
|---------------------------------------|----------|------------|
| <b>760</b>                            | 1 1/4"   | G760114    |
| <b>Verzinkte trekvraste koppeling</b> | 1 1/2"   | G760112    |
| - staal x staal                       | 2"       | G760200    |

Artikelgroep: 14.02.30



|                                       | Afmeting    | Artikelnr. |
|---------------------------------------|-------------|------------|
| <b>761</b>                            | 1 1/4" x 40 | G761114    |
| <b>Verzinkte trekvraste koppeling</b> | 1 1/2" x 50 | G761112    |
| - staal x PE                          | 2" x 63     | G761200    |

Artikelgroep: 14.02.30





A large light blue rectangular area with horizontal ruling lines, intended for taking notes.

14

# Productgroep 15

PE Drukleidingen > PVC Drukleidingen > PP Drukleidingen  
> Afstandbediende afsluiters > C-PVC Programma >  
Blue-system programma > Binnen- en buitenriolering  
> Kabelbescherming en telecom > Milieu programma  
> Tanks > Folie en geotextielen > Halffabrikaten >  
RVS Programma > Malleable programma > Sanitair  
en verwarming > Metalen appendages en fittingen >  
Slangen en koppelingen > Pompen, filters en kabel  
> Lijm, reiniger en toebehoren > Bevestigingsmaterialen >  
Machines en gereedschappen

>> Sanitair en verwarming

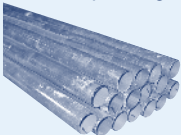
# Milder

— VEELZIJDIG IN LEIDINGSYSTEMEN —

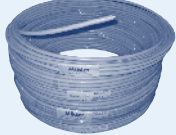
# 15.01 Buis voor sanitair en verwarming

## Koperen- en Wicu buis

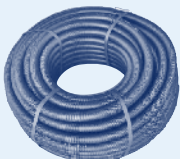
|                          | Afmeting in mm | Artikelnr. |
|--------------------------|----------------|------------|
| <b>2501</b>              | 10             | 2501010    |
| <b>Rood koperen buis</b> | 12             | 2501012    |
| - lengten: standaard     | 15             | 2501015    |
| op 5 meter               | 22             | 2501022    |
| - met KIWA-keur waar     | 28             | 2501028    |
| van toepassing           | 35             | 2501035    |
|                          | 42             | 2501042    |
|                          | 54             | 2501054    |
| Artikelgroep: 15.01.05   |                |            |



|                       | Afmeting in mm | Artikelnr.             |
|-----------------------|----------------|------------------------|
| <b>2504</b>           | 12             | 2504012                |
| <b>Wicu buis</b>      | 15             | 2504015                |
| - rollengte: 25 meter | 22             | 2504022                |
| - met KIWA-keur waar  |                | Artikelgroep: 15.01.05 |
| van toepassing        |                |                        |



|                                | Afmeting in mm | Buismaat koper | Rollengte in meter | Artikelnr. |
|--------------------------------|----------------|----------------|--------------------|------------|
| <b>2509</b>                    | 13             | 12             | 50                 | 2509013050 |
| <b>PE Flexibele mantelbuis</b> | 16             | 15             | 25                 | 2509016025 |
| - geribd                       | 16             | 15             | 50                 | 2509016050 |
|                                | 19             | 18             | 50                 | 2509019050 |
|                                | 23             | 22             | 50                 | 2509023050 |
|                                | 29             | 28             | 25                 | 2509029025 |
|                                | 36             | 35             | 25                 | 2509036025 |
|                                | 48             | 42             | 25                 | 2509048025 |
| Artikelgroep: 15.01.10         |                |                |                    |            |



Voor beugels voor koperen buizen zie Groep 20, blz. 276.


Voor flamco beugels zie Groep 20, blz. 277.

# 15.02 Fittingen voor sanitair en verwarming


## Messing knelfittingen

- Met KIWA-keur (waar van toepassing).
- Voor water.

|                         | Afmeting in mm | Artikelnr. |
|-------------------------|----------------|------------|
| <b>8253</b>             | 10             | 8253010    |
| <b>Messing</b>          | 12             | 8253012    |
| <b>rechte koppeling</b> | 15             | 8253015    |
| - 2 x knel              | 22             | 8253022    |
|                         | 28             | 8253028    |
|                         | 35             | 8253035    |
|                         | 42             | 8253042    |
|                         | 54             | 8253054    |
| Artikelgroep: 15.02.05  |                |            |



|                        | Afmeting in mm | Artikelnr. |
|------------------------|----------------|------------|
| <b>8256</b>            | 12             | 8256012    |
| <b>Messing</b>         | 15             | 8256015    |
| <b>eindkoppeling</b>   | 22             | 8256022    |
| - 1 x knel             | 28             | 8256028    |
|                        | 35             | 8256035    |
| Artikelgroep: 15.02.05 |                |            |



|                         | Afmeting in mm | Artikelnr. |
|-------------------------|----------------|------------|
| <b>8293</b>             | 12 x 10        | 8293012010 |
| <b>Messing</b>          | 15 x 12        | 8293015012 |
| <b>verloopkoppeling</b> | 22 x 15        | 8293022015 |
| - 2 x knel              | 28 x 22        | 8293028022 |
|                         | 35 x 15        | 8293035015 |
|                         | 35 x 22        | 8293035022 |
| Artikelgroep: 15.02.05  |                |            |



|                           | Afmeting    | Artikelnr. |
|---------------------------|-------------|------------|
| <b>8258</b>               | 12 x 3/8"   | 8258012038 |
| <b>Messing schroefbus</b> | 12 x 1/2"   | 8258012012 |
| - knel x binnendraad      | 15 x 3/8"   | 8258015038 |
|                           | 15 x 1/2"   | 8258015012 |
|                           | 15 x 3/4"   | 8258015034 |
|                           | 22 x 1/2"   | 8258022012 |
|                           | 22 x 3/4"   | 8258022034 |
|                           | 22 x 1"     | 8258022100 |
|                           | 28 x 1"     | 8258028100 |
|                           | 35 x 1 1/4" | 8258035114 |
|                           | 42 x 1 1/2" | 8258042112 |
|                           | 54 x 2"     | 8258054200 |
| Artikelgroep: 15.02.05    |             |            |



## Messing knelfittingen

|  | Afmeting    | Artikelnr. |
|--|-------------|------------|
| <b>8254</b><br><b>Messing puntstuk</b><br>- knel x buitendraad | 12 x 3/8"   | 8254012038 |
|  | 12 x 1/2"   | 8254012012 |
|  | 15 x 3/8"   | 8254015038 |
|  | 15 x 1/2"   | 8254015012 |
|  | 15 x 3/4"   | 8254015034 |
|  | 22 x 1/2"   | 8254022012 |
|  | 22 x 3/4"   | 8254022034 |
|  | 22 x 1"     | 8254022100 |
|  | 28 x 1"     | 8254028100 |
|  | 35 x 1 1/4" | 8254035114 |
|  | 42 x 1 1/2" | 8254042112 |
|  | 54 x 2"     | 8254054200 |

Artikelgroep: 15.02.05



|   | Afmeting  | Artikelnr. |
|---|-----------|------------|
| <b>8255</b><br><b>Messing overgangs-kniekoppeling</b><br>- knel x buitendraad | 12 x 3/8" | 8255012038 |
|   | 12 x 1/2" | 8255012012 |
|   | 15 x 1/2" | 8255015012 |
|   | 15 x 3/4" | 8255015034 |
|   | 22 x 3/4" | 8255022034 |
|   | 22 x 1"   | 8255022100 |
|   | 28 x 3/4" | 8255028034 |
|   | 28 x 1"   | 8255028100 |

Artikelgroep: 15.02.05



|   | Afmeting in mm | Artikelnr. |
|---|----------------|------------|
| <b>8252</b><br><b>Messing kniekoppeling</b><br>- 2 x knel | 10             | 8252010    |
|   | 12             | 8252012    |
|   | 15             | 8252015    |
|   | 22             | 8252022    |
|   | 28             | 8252028    |
|   | 35             | 8252035    |
|   | 42             | 8252042    |
|   | 54             | 8252054    |

Artikelgroep: 15.02.05



|   | Afmeting in mm | Artikelnr. |
|---|----------------|------------|
| <b>8250</b><br><b>Messing T-koppeling</b><br>- 3 x knel | 10             | 8250010    |
|   | 12             | 8250012    |
|   | 15             | 8250015    |
|   | 22             | 8250022    |
|   | 28             | 8250028    |
|   | 35             | 8250035    |
|   | 42             | 8250042    |
|   | 54             | 8250054    |

Artikelgroep: 15.02.05



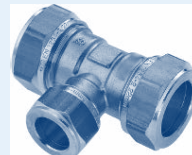
|  | Afmeting in mm | Artikelnr. |
|--|----------------|------------|
| <b>8292</b><br><b>Messing kniekoppeling</b><br>- verlopend<br>- 2 x knel | 15 x 12        | 8292015012 |
|  | 22 x 15        | 8292022015 |
|  | 28 x 15        | 8292028015 |
|  | 28 x 22        | 8292028022 |

Artikelgroep: 15.02.05



|   | Afmeting in mm | Artikelnr. |
|---|----------------|------------|
| <b>8290</b><br><b>Messing verloop T-koppeling</b><br>- 3 x knel | 12 x 15 x 12   | 8290121512 |
|   | 15 x 12 x 12   | 8290151212 |
|   | 15 x 12 x 15   | 8290151215 |
|   | 15 x 15 x 12   | 8290151512 |
|   | 15 x 22 x 15   | 8290152215 |
|   | 22 x 15 x 15   | 8290221515 |
|   | 22 x 15 x 22   | 8290221522 |
|   | 22 x 22 x 15   | 8290222215 |
|   | 22 x 28 x 22   | 8290222822 |
|   | 28 x 15 x 22   | 8290281522 |
|   | 28 x 15 x 28   | 8290281528 |
|   | 28 x 22 x 22   | 8290282222 |
|   | 28 x 22 x 28   | 8290282228 |
|   | 28 x 28 x 15   | 8290282815 |
|   | 28 x 28 x 22   | 8290282822 |
|   | 35 x 15 x 35   | 8290351535 |
|   | 35 x 28 x 35   | 8290352835 |

Artikelgroep: 15.02.05



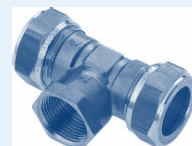
|   | Afmeting    | Artikelnr. |
|---|-------------|------------|
| <b>8259</b><br><b>Messing overgangs-kniekoppeling</b><br>- knel x binnendraad | 12 x 3/8"   | 8259012038 |
|   | 15 x 3/8"   | 8259015038 |
|   | 15 x 1/2"   | 8259015012 |
|   | 15 x 3/4"   | 8259015034 |
|   | 22 x 1/2"   | 8259022012 |
|   | 22 x 3/4"   | 8259022034 |
|   | 22 x 1"     | 8259022100 |
|   | 28 x 3/4"   | 8259028034 |
|   | 28 x 1"     | 8259028100 |
|   | 35 x 1 1/4" | 8259035114 |
|   | 42 x 1 1/2" | 8259042112 |
|   | 54 x 2"     | 8259054200 |

Artikelgroep: 15.02.05



|  | Afmeting       | Artikelnr. |
|--|----------------|------------|
| <b>8264</b><br><b>Messing overgangs T-koppeling</b><br>- met binnendraad | 15 x 1/4" x 15 | 8264015014 |
|  | 15 x 3/8" x 15 | 8264015038 |
|  | 15 x 1/2" x 15 | 8264015012 |
|  | 22 x 1/2" x 22 | 8264022012 |
|  | 22 x 3/4" x 22 | 8264022034 |
|  | 28 x 1/2" x 28 | 8264028012 |
|  | 28 x 3/4" x 28 | 8264028034 |


Artikelgroep: 15.02.05




# 15.02 Fittingen voor sanitair en verwarming

## Messing knelfittingen


|                          | Afmeting  | Artikelnr. |
|--------------------------|-----------|------------|
| <b>8257</b>              | 15 x 1/2" | 8257015012 |
| <b>Messing muurplaat</b> | 15 x 3/4" | 8257015034 |
| - knel x binnendraad     | 22 x 1/2" | 8257022012 |
|                          | 22 x 3/4" | 8257022034 |
| Artikelgroep: 15.02.05   |           |            |




|                         | Afmeting in mm | Artikelnr. |
|-------------------------|----------------|------------|
| <b>8407</b>             | 10             | 8407010    |
| <b>Messing knelring</b> | 12             | 8407012    |
|                         | 15             | 8407015    |
|                         | 22             | 8407022    |
|                         | 28             | 8407028    |
|                         | 35             | 8407035    |
|                         | 42             | 8407042    |
|                         | 54             | 8407054    |
| Artikelgroep: 15.02.05  |                |            |




|                               | Afmeting in mm | Artikelnr. |
|-------------------------------|----------------|------------|
| <b>8281</b>                   | 12             | 8281012    |
| <b>Messing afsluitplaatje</b> | 15             | 8281015    |
| - soldeer                     | 22             | 8281022    |
|                               | 28             | 8281028    |
| Artikelgroep: 15.02.05        |                |            |



|                           | Afmeting in mm | Artikelnr. |
|---------------------------|----------------|------------|
| <b>8120</b>               | 12 x 10        | 8120012010 |
| <b>Messing verloopset</b> | 15 x 10        | 8120015010 |
|                           | 15 x 12        | 8120015012 |
|                           | 22 x 12        | 8120022012 |
|                           | 22 x 15        | 8120022015 |
|                           | 28 x 12        | 8120028012 |
|                           | 28 x 15        | 8120028015 |
|                           | 28 x 22        | 8120028022 |
|                           | 35 x 22        | 8120035022 |
|                           | 35 x 28        | 8120035028 |
|                           | 42 x 28        | 8120042028 |
|                           | 42 x 35        | 8120042035 |
|                           | 54 x 35        | 8120054035 |
|                           | 54 x 42        | 8120054042 |
| Artikelgroep: 15.02.05    |                |            |



|                                    | Buitendiameter x wanddikte in mm | Artikelnr. |
|------------------------------------|----------------------------------|------------|
| <b>8251</b>                        | 12 x 1                           | 8251012    |
| <b>Messing steunhuls roodkoper</b> | 15 x 1                           | 8251015    |
| - voor zacht koper/ stalen buis    | 22 x 1                           | 8251022    |
| Artikelgroep: 15.02.05             |                                  |            |



## Messing draadfittingen

- Met KIWA-keur (waar van toepassing).
- Voor water.

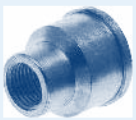
|                        | Afmeting | Artikelnr. |
|------------------------|----------|------------|
| <b>8297</b>            | 1/8"     | 8297018    |
| <b>Messing sok</b>     | 1/4"     | 8297014    |
| - 2 x binnendraad      | 3/8"     | 8297038    |
|                        | 1/2"     | 8297012    |
|                        | 3/4"     | 8297034    |
|                        | 1"       | 8297100    |
|                        | 1 1/4"   | 8297114    |
|                        | 1 1/2"   | 8297112    |
|                        | 2"       | 8297200    |
|                        | 2 1/2"   | 8297212    |
|                        | 3"       | 8297300    |
| Artikelgroep: 15.02.10 |          |            |




|                        | Afmeting | Artikelnr. |
|------------------------|----------|------------|
| <b>8291</b>            | 1/4"     | 8291014    |
| <b>Messing eindkap</b> | 3/8"     | 8291038    |
| - binnendraad          | 1/2"     | 8291012    |
|                        | 3/4"     | 8291034    |
|                        | 1"       | 8291100    |
|                        | 1 1/4"   | 8291114    |
|                        | 1 1/2"   | 8291112    |
|                        | 2"       | 8291200    |
| Artikelgroep: 15.02.10 |          |            |



|                            | Afmeting    | Artikelnr. |
|----------------------------|-------------|------------|
| <b>8295</b>                | 1/4" x 1/8" | 8295014018 |
| <b>Messing verloop sok</b> | 3/8" x 1/4" | 8295038014 |
| - 2 x binnendraad          | 1/2" x 1/4" | 8295012014 |
|                            | 1/2" x 3/8" | 8295012038 |
|                            | 3/4" x 1/2" | 8295034012 |
|                            | 1" x 1/2"   | 8295100012 |
|                            | 1" x 3/4"   | 8295100034 |
| Artikelgroep: 15.02.10     |             |            |



|                        | Afmeting | Artikelnr. |
|------------------------|----------|------------|
| <b>8286</b>            | 1/8"     | 8286018    |
| <b>Messing plug</b>    | 1/4"     | 8286014    |
| - met zeskant          | 3/8"     | 8286038    |
|                        | 1/2"     | 8286012    |
|                        | 3/4"     | 8286034    |
|                        | 1"       | 8286100    |
|                        | 1 1/4"   | 8286114    |
|                        | 1 1/2"   | 8286112    |
|                        | 2"       | 8286200    |
| Artikelgroep: 15.02.10 |          |            |



## Messing draadfittingen

|   | Afmeting               | Artikelnr. |
|---|------------------------|------------|
| <b>8296</b><br>Messing<br>verloopenippel<br>- 2 x buitendraad | 1/4" x 1/8"            | 8296014018 |
|   | 3/8" x 1/8"            | 8296038018 |
|   | 3/8" x 1/4"            | 8296038014 |
|   | 1/2" x 1/4"            | 8296012014 |
|   | 1/2" x 3/8"            | 8296012038 |
|   | 3/4" x 3/8"            | 8296034038 |
|   | 3/4" x 1/2"            | 8296034012 |
|   | 1" x 1/2"              | 8296100012 |
|   | 1" x 3/4"              | 8296100034 |
|   | 1 1/4" x 3/4"          | 8296114034 |
|   | 1 1/4" x 1"            | 8296114100 |
|   | 1 1/2" x 1"            | 8296112100 |
|   | 1 1/2" x 1 1/4"        | 8296112114 |
|   | 2" x 1"                | 8296200100 |
|   | 2" x 1 1/4"            | 8296200114 |
|   | 2" x 1 1/2"            | 8296200112 |
|   | 2 1/2" x 2"            | 8296212200 |
| 3" x 2"   | 8296300200             |            |
| 3" x 2 1/2"   | 8296300212             |            |
|   | Artikelgroep: 15.02.10 |            |



|   | Afmeting               | Artikelnr. |
|---|------------------------|------------|
| <b>8299</b><br>Messing<br>verloopping<br>- buitendraad x<br>binnendraad | 1/4" x 1/8"            | 8299014018 |
|   | 3/8" x 1/8"            | 8299038018 |
|   | 3/8" x 1/4"            | 8299038014 |
|   | 1/2" x 1/8"            | 8299012018 |
|   | 1/2" x 1/4"            | 8299012014 |
|   | 1/2" x 3/8"            | 8299012038 |
|   | 3/4" x 1/4"            | 8299034014 |
|   | 3/4" x 3/8"            | 8299034038 |
|   | 3/4" x 1/2"            | 8299034012 |
|   | 1" x 1/2"              | 8299100012 |
|   | 1" x 3/4"              | 8299100034 |
|   | 1 1/4" x 1/2"          | 8299114012 |
|   | 1 1/4" x 3/4"          | 8299114034 |
|   | 1 1/4" x 1"            | 8299114100 |
|   | 1 1/2" x 1/2"          | 8299112012 |
|   | 1 1/2" x 1"            | 8299112100 |
|   | 1 1/2" x 1 1/4"        | 8299112114 |
|   | 2" x 1/2"              | 8299200012 |
|   | 2" x 3/4"              | 8299200034 |
|   | 2" x 1"                | 8299200100 |
| 2" x 1 1/4"   | 8299200114             |            |
| 2" x 1 1/2"   | 8299200112             |            |
| 2 1/2" x 1 1/2"   | 8299212112             |            |
| 3" x 2"   | 8299300200             |            |
|   | Artikelgroep: 15.02.10 |            |



|   | Afmeting               | Artikelnr. |
|---|------------------------|------------|
| <b>8285</b><br>Messing kruisstuk<br>- 4 x binnendraad | 1/2"                   | 8285012    |
|   | 3/4"                   | 8285034    |
|   | 1"                     | 8285100    |
|   | Artikelgroep: 15.02.10 |            |



|  | Afmeting               | Artikelnr. |
|--|------------------------|------------|
| <b>8289</b><br>Messing knie<br>- 2 x binnendraad | 1/8"                   | 8289018    |
|  | 1/4"                   | 8289014    |
|  | 3/8"                   | 8289038    |
|  | 1/2"                   | 8289012    |
|  | 3/4"                   | 8289034    |
|  | 1"                     | 8289100    |
|  | 1 1/4"                 | 8289114    |
|  | 1 1/2"                 | 8289112    |
|  | 2"                     | 8289200    |
|  | 2 1/2"                 | 8289212    |
|  | 3"                     | 8289300    |
|  | Artikelgroep: 15.02.10 |            |



|   | Afmeting               | Artikelnr. |
|---|------------------------|------------|
| <b>8298</b><br>Messing dubbele<br>nippel<br>- 2 x buitendraad | 1/8"                   | 8298018    |
|   | 1/4"                   | 8298014    |
|   | 3/8"                   | 8298038    |
|   | 1/2"                   | 8298012    |
|   | 3/4"                   | 8298034    |
|   | 1"                     | 8298100    |
|   | 1 1/4"                 | 8298114    |
|   | 1 1/2"                 | 8298112    |
|   | 2"                     | 8298200    |
|   | 2 1/2"                 | 8298212    |
|   | 3"                     | 8298300    |
|   | Artikelgroep: 15.02.10 |            |



|   | Afmeting               | Artikelnr. |
|---|------------------------|------------|
| <b>8288</b><br>Messing knie<br>- binnendraad x<br>buitendraad | 1/4"                   | 8288014    |
|   | 3/8"                   | 8288038    |
|   | 1/2"                   | 8288012    |
|   | 3/4"                   | 8288034    |
|   | 1"                     | 8288100    |
|   | 1 1/4"                 | 8288114    |
|   | 1 1/2"                 | 8288112    |
|   | 2"                     | 8288200    |
|   | Artikelgroep: 15.02.10 |            |



|  | Afmeting               | Artikelnr. |
|--|------------------------|------------|
| <b>8294</b><br>Messing T-stuk 90°<br>- 3 x binnendraad | 1/8"                   | 8294018    |
|  | 1/4"                   | 8294014    |
|  | 3/8"                   | 8294038    |
|  | 1/2"                   | 8294012    |
|  | 3/4"                   | 8294034    |
|  | 1"                     | 8294100    |
|  | 1 1/4"                 | 8294114    |
|  | 1 1/2"                 | 8294112    |
|  | 2"                     | 8294200    |
|  | 2 1/2"                 | 8294212    |
|  | 3"                     | 8294300    |
|  | Artikelgroep: 15.02.10 |            |




# 15.02 Fittingen voor sanitair en verwarming

## Messing soldeerfittingen

- Met KIWA-keur (waar van toepassing).
- Voor water.

|  | Afmeting in mm | Artikelnr.             |
|--|----------------|------------------------|
| <b>7253</b><br>Messing sok<br>- 2 x capillair<br> | 12             | 7253012                |
|  | 15             | 7253015                |
|  | 22             | 7253022                |
|  | 28             | 7253028                |
|  | 35             | 7253035                |
|  | 42             | 7253042                |
|  | 54             | 7253054                |
|  |                | Artikelgroep: 15.02.15 |

|  | Afmeting             | Artikelnr.             |
|--|----------------------|------------------------|
| <b>7256</b><br>Messing schroefbus<br>- capillair x lange<br>binnendraad<br> | 12 x $\frac{3}{8}$ " | 7256012038             |
|  | 15 x $\frac{1}{2}$ " | 7256015012             |
|  | 22 x $\frac{3}{4}$ " | 7256022034             |
|  | 28 x 1"              | 7256028100             |
|  |                      | Artikelgroep: 15.02.15 |

|  | Afmeting in mm         | Artikelnr. |
|--|------------------------|------------|
| <b>7281</b><br>Messing kap<br>- 1 x capillair<br> | 12                     | 7281012    |
|  | 15                     | 7281015    |
|  | 22                     | 7281022    |
|  | 28                     | 7281028    |
|  | 35                     | 7281035    |
|  | 42                     | 7281042    |
|  | Artikelgroep: 15.02.15 |            |

|   | Afmeting               | Artikelnr. |
|---|------------------------|------------|
| <b>7241</b><br>Messing puntstuk<br>- capillair x conische<br>buitendraad<br> | 12 x $\frac{3}{8}$ "   | 7241012038 |
|   | 15 x $\frac{1}{2}$ "   | 7241015012 |
|   | 15 x $\frac{3}{4}$ "   | 7241015034 |
|   | 22 x $\frac{1}{2}$ "   | 7241022012 |
|   | 22 x $\frac{3}{4}$ "   | 7241022034 |
|   | 28 x 1"                | 7241028100 |
|   | 35 x $1\frac{1}{4}$ "  | 7241035114 |
|   | 42 x $1\frac{1}{2}$ "  | 7241042112 |
|   | 54 x 2"                | 7241054200 |
|   | Artikelgroep: 15.02.15 |            |

|   | Afmeting in mm | Artikelnr.             |
|---|----------------|------------------------|
| <b>7293</b><br>Messing verloopsok<br>- 2 x capillair<br> | 15 x 12        | 7293015012             |
|   | 22 x 15        | 7293022015             |
|   | 28 x 15        | 7293028015             |
|   | 28 x 22        | 7293028022             |
|   | 35 x 28        | 7293035028             |
|   | 42 x 35        | 7293042035             |
|   | 54 x 42        | 7293054042             |
|   |                | Artikelgroep: 15.02.15 |

|  | Afmeting              | Artikelnr.             |
|--|-----------------------|------------------------|
| <b>7242</b><br>Messing puntstuk<br>- capillair<br>x buitendraad<br>- kort model<br> | 15 x $\frac{1}{2}$ "  | 7242015012             |
|  | 22 x $\frac{1}{2}$ "  | 7242022012             |
|  | 22 x 1"               | 7242022100             |
|  | 35 x $1\frac{1}{4}$ " | 7242035114             |
|  | 42 x $1\frac{1}{2}$ " | 7242042112             |
|  | 54 x 2"               | 7242054200             |
|  |                       | Artikelgroep: 15.02.15 |

|   | Afmeting in mm | Artikelnr.             |
|---|----------------|------------------------|
| <b>7294</b><br>Messing<br>soldeerring<br>- fitting x capillair<br> | 12 u x 10      | 7294012010             |
|   | 12 u x 11      | 7294012011             |
|   | 15 u x 12      | 7294015012             |
|   | 15 u x 14      | 7294015014             |
|   | 22 u x 15      | 7294015022             |
|   | 28 u x 15      | 7294028015             |
|   | 28 u x 22      | 7294028022             |
|   | 35 u x 28      | 7294035028             |
|   |                | Artikelgroep: 15.02.15 |

|   | Afmeting in mm         | Artikelnr. |
|---|------------------------|------------|
| <b>7252</b><br>Messing knie<br>- 2 x capillair<br> | 12                     | 7252012    |
|   | 15                     | 7252015    |
|   | 22                     | 7252022    |
|   | 28                     | 7252028    |
|   | 35                     | 7252035    |
|   | 42                     | 7252042    |
|   | 54                     | 7252054    |
|   | Artikelgroep: 15.02.15 |            |

|  | Afmeting               | Artikelnr. |
|--|------------------------|------------|
| <b>7255</b><br>Messing schroefbus<br>- capillair x<br>binnendraad<br> | 12 x $\frac{3}{8}$ "   | 7255012038 |
|  | 12 x $\frac{1}{2}$ "   | 7255012012 |
|  | 15 x $\frac{3}{8}$ "   | 7255015038 |
|  | 15 x $\frac{1}{2}$ "   | 7255015012 |
|  | 15 x $\frac{3}{4}$ "   | 7255015034 |
|  | 22 x $\frac{3}{4}$ "   | 7255022034 |
|  | Artikelgroep: 15.02.15 |            |

|   | Afmeting in mm | Artikelnr.             |
|---|----------------|------------------------|
| <b>7292</b><br>Messing<br>verloopknie<br>- 2 x capillair<br> | 15 x 12        | 7292015012             |
|   | 22 x 12        | 7292022012             |
|   | 22 x 15        | 7292022015             |
|   | 28 x 22        | 7292028022             |
|   |                | Artikelgroep: 15.02.15 |

## Messing soldeerfittingen

|                     | Afmeting             | Artikelnr.             |
|---------------------|----------------------|------------------------|
| <b>7259</b>         | 12 x $\frac{3}{8}$ " | 7259012038             |
| <b>Messing knie</b> | 15 x $\frac{3}{8}$ " | 7259015038             |
| - capillair x       | 15 x $\frac{1}{2}$ " | 7259015012             |
| binnendraad         | 22 x $\frac{3}{4}$ " | 7259022034             |
|                     |                      | Artikelgroep: 15.02.15 |



|                     | Afmeting             | Artikelnr.             |
|---------------------|----------------------|------------------------|
| <b>7243</b>         | 12 x $\frac{3}{8}$ " | 7243012038             |
| <b>Messing knie</b> | 15 x $\frac{3}{8}$ " | 7243015038             |
| - capillair x lange | 15 x $\frac{1}{2}$ " | 7243015012             |
| binnendraad         | 22 x $\frac{3}{4}$ " | 7243022034             |
|                     |                      | Artikelgroep: 15.02.15 |




|                     | Afmeting             | Artikelnr.             |
|---------------------|----------------------|------------------------|
| <b>7244</b>         | 12 x $\frac{3}{8}$ " | 7244012038             |
| <b>Messing knie</b> | 12 x $\frac{1}{2}$ " | 7244012012             |
| - capillair x       | 15 x $\frac{3}{8}$ " | 7244015038             |
| buitendraad         | 15 x $\frac{1}{2}$ " | 7244015012             |
|                     | 22 x $\frac{3}{4}$ " | 7244022034             |
|                     |                      | Artikelgroep: 15.02.15 |



|                     | Afmeting             | Artikelnr.             |
|---------------------|----------------------|------------------------|
| <b>7245</b>         | 12 x $\frac{3}{8}$ " | 7245012038             |
| <b>Messing knie</b> | 12 x $\frac{1}{2}$ " | 7245012012             |
| - capillair x       | 15 x $\frac{3}{8}$ " | 7245015038             |
| buitendraad         | 15 x $\frac{1}{2}$ " | 7245015012             |
| - met conische      | 22 x $\frac{3}{4}$ " | 7245022034             |
| gasdraad            |                      | Artikelgroep: 15.02.15 |



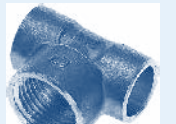
|                       | Afmeting in mm | Artikelnr.             |
|-----------------------|----------------|------------------------|
| <b>7250</b>           | 12             | 7250012                |
| <b>Messing T-stuk</b> | 15             | 7250015                |
| - 3 x capillair       | 22             | 7250022                |
|                       | 28             | 7250028                |
|                       | 35             | 7250035                |
|                       |                | Artikelgroep: 15.02.15 |




|                       | Afmeting in mm | Artikelnr.             |
|-----------------------|----------------|------------------------|
| <b>7290</b>           | 12 x 15 x 12   | 7290012015012          |
| <b>Messing</b>        | 15 x 12 x 12   | 7290015012012          |
| <b>verloop T-stuk</b> | 15 x 12 x 15   | 7290015012015          |
| - 3 x capillair       | 15 x 15 x 12   | 7290015015012          |
|                       | 15 x 22 x 15   | 7290015022015          |
|                       | 22 x 12 x 22   | 7290022012022          |
|                       | 22 x 15 x 15   | 7290022015015          |
|                       | 22 x 15 x 22   | 7290022015022          |
|                       | 22 x 22 x 15   | 7290022022015          |
|                       | 22 x 28 x 22   | 7290022028022          |
|                       | 28 x 15 x 28   | 7290028015028          |
|                       | 28 x 22 x 22   | 7290028022022          |
|                       | 28 x 22 x 28   | 7290028022028          |
|                       | 28 x 28 x 22   | 7290028028022          |
|                       | 35 x 22 x 35   | 7290035022035          |
|                       |                | Artikelgroep: 15.02.15 |



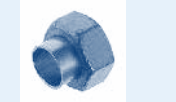
|                       | Afmeting                  | Artikelnr.             |
|-----------------------|---------------------------|------------------------|
| <b>7264</b>           | 12 x $\frac{3}{8}$ " x 12 | 7264012038             |
| <b>Messing T-stuk</b> | 12 x $\frac{1}{4}$ " x 12 | 7264012014             |
| - capillair x         | 15 x $\frac{1}{4}$ " x 15 | 7264015014             |
| binnendraad           | 15 x $\frac{3}{8}$ " x 15 | 7264015038             |
|                       | 15 x $\frac{1}{2}$ " x 15 | 7264015012             |
|                       | 22 x $\frac{1}{4}$ " x 22 | 7264022014             |
|                       | 22 x $\frac{1}{2}$ " x 22 | 7264022012             |
|                       | 22 x $\frac{3}{4}$ " x 22 | 7264022034             |
|                       | 28 x $\frac{1}{2}$ " x 28 | 7264028012             |
|                       |                           | Artikelgroep: 15.02.15 |



|                         | Afmeting                  | Artikelnr.             |
|-------------------------|---------------------------|------------------------|
| <b>7248</b>             | 12 x 12 x $\frac{1}{4}$ " | 7248012012014          |
| <b>Messing T-stuk</b>   | 15 x 15 x $\frac{1}{4}$ " | 7248015015014          |
| - capillair x capillair |                           | Artikelgroep: 15.02.15 |
| x binnendraad           |                           |                        |



|                                   | Afmeting              | Artikelnr.             |
|-----------------------------------|-----------------------|------------------------|
| <b>7251</b>                       | 12 x $\frac{3}{8}$ "  | 7251012038             |
| <b>Messing 2-delige koppeling</b> | 12 x $\frac{1}{2}$ "  | 7251012012             |
| - vlakke dichting                 | 15 x $\frac{1}{2}$ "  | 7251015012             |
| - capillair                       | 15 x $\frac{3}{4}$ "  | 7251015034             |
| x binnendraad                     | 22 x 1"               | 7251022100             |
|                                   | 28 x $1\frac{1}{4}$ " | 7251028114             |
|                                   | 35 x $1\frac{1}{2}$ " | 7251035112             |
|                                   | 42 x 2"               | 7251042200             |
|                                   | 54 x $2\frac{1}{2}$ " | 7251054212             |
|                                   |                       | Artikelgroep: 15.02.15 |



|                          | Afmeting             | Artikelnr.             |
|--------------------------|----------------------|------------------------|
| <b>7257</b>              | 12 x $\frac{3}{8}$ " | 7257012038             |
| <b>Messing muurplaat</b> | 12 x $\frac{1}{2}$ " | 7257012012             |
| - laag                   | 15 x $\frac{3}{8}$ " | 7257015038             |
| - capillair x            | 15 x $\frac{1}{2}$ " | 7257015012             |
| binnendraad              | 22 x $\frac{3}{4}$ " | 7257022034             |
|                          | 28 x 1"              | 7257028100             |
|                          |                      | Artikelgroep: 15.02.15 |






# 15.03 Armaturen voor sanitair en verwarming

## Messing armaturen voor sanitair en verwarming

- Met KIWA-keur (waar van toepassing).
- Voor water.

|   | Afmeting | Artikelnr.             |
|---|----------|------------------------|
| <b>8260</b><br><b>Messing stopkraan</b><br>- met aftapmogelijkheid<br>- 2 x binnendraad | 1/2"     | 8260012                |
|   | 3/4"     | 8260034                |
|   | 1"       | 8260100                |
|   |          | Artikelgroep: 15.03.05 |



|  | Afmeting in mm | Artikelnr.             |
|--|----------------|------------------------|
| <b>8265</b><br><b>Messing stopkraan</b><br>- met aftapmogelijkheid<br>- 2 x knel | 12             | 8265012                |
|  | 15             | 8265015                |
|  | 22             | 8265022                |
|  | 28             | 8265028                |
|  |                | Artikelgroep: 15.03.05 |




|   | Afmeting in mm | Artikelnr.             |
|---|----------------|------------------------|
| <b>8266</b><br><b>Messing stopkraan</b><br>- met aftapmogelijkheid<br>- 2 x soldeer | 15             | 8266015                |
|   |                | Artikelgroep: 15.03.05 |



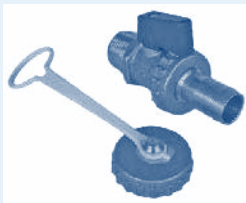
|   | Afmeting in mm | Artikelnr.             |
|---|----------------|------------------------|
| <b>8262</b><br><b>Messing terugslagklep</b><br>- 2 x soldeer<br>- met aftapmogelijkheid | 15             | 8262015                |
|   |                | Artikelgroep: 15.03.05 |



|   | Afmeting | Artikelnr.             |
|---|----------|------------------------|
| <b>8261</b><br><b>Aftapper</b><br>- voor artikelnr. 8260 en 8262<br>- met fiberring | 1/4"     | 8261                   |
|   |          | Artikelgroep: 15.03.05 |



|   | Afmeting | Artikelnr.             |
|---|----------|------------------------|
| <b>8263</b><br><b>Messing vul- en aftapkraan</b><br>- met buitendraad | 1/2"     | 8263012                |
|   | 3/4"     | 8263034                |
|   |          | Artikelgroep: 15.03.05 |



# Productgroep 16

PE Drukleidingen > PVC Drukleidingen > PP Drukleidingen  
> Afstandbediende afsluiters > C-PVC Programma >  
Blue-system programma > Binnen- en buitenriolering  
> Kabelbescherming en telecom > Milieu programma  
> Tanks > Folie en geotextielen > Halffabrikaten >  
RVS Programma > Malleable programma > Sanitair  
en verwarming > Metalen appendages en fittingen >  
Slangen en koppelingen > Pompen, filters en kabel  
> Lijm, reiniger en toebehoren > Bevestigingsmaterialen >  
Machines en gereedschappen

>> Metalen appendages en fittingen

# Milder

— VEELZIJDIG IN LEIDINGSYSTEMEN —

# 16.01 Fucoli programma

## Gietijzeren afsluiters

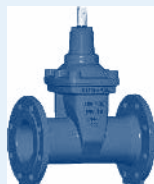
- Met KIWA-keur (waar van toepassing).

|   | DN  | Geboord/drukklasse PN | Artikelnr. |
|---|-----|-----------------------|------------|
| <b>Fig. 100</b><br><b>GY Flensafsluiter F4 korte inbouw voor water</b><br>- epoxy gecoat<br>- vervangbare EPDM afdichtingen<br>- spindel RVS420 | 40  | 10/16                 | 10725014   |
|   | 50  | 10/16                 | 10725024   |
|   | 65  | 10/16                 | 10725044   |
|   | 80  | 10/16                 | 10725054   |
|   | 100 | 10/16                 | 10725064   |
|   | 125 | 10/16                 | 10725074   |
|   | 150 | 10/16                 | 10725084   |
|   | 200 | 10                    | 10725094   |
|   | 250 | 10                    | 10725114   |
|   | 300 | 10                    | 10725134   |
|   | 350 | 10                    | 10725154   |
|   | 400 | 10                    | 10725174   |
|   | 450 | 10                    | 10725194   |
|   | 500 | 10                    | 10725214   |



Artikelmgroep: 16.01.05

|   | DN  | Geboord/drukklasse PN | Artikelnr. |
|---|-----|-----------------------|------------|
| <b>Fig. 101</b><br><b>GY Flensafsluiter F5 lange inbouw voor water</b><br>- epoxy gecoat<br>- vervangbare EPDM afdichtingen<br>- spindel RVS420 | 40  | 10/16                 | 10712014   |
|   | 50  | 10/16                 | 10712024   |
|   | 65  | 10/16                 | 10712044   |
|   | 80  | 10/16                 | 10712054   |
|   | 100 | 10/16                 | 10712064   |
|   | 125 | 10/16                 | 10712074   |
|   | 150 | 10/16                 | 10712084   |
|   | 200 | 10                    | 10712094   |
|   | 250 | 10                    | 10712104   |
|   | 300 | 10                    | 10712114   |
|   | 350 | 10                    | 10712124   |
|   | 400 | 10                    | 10712134   |
|   | 450 | 10                    | 10712144   |
|   | 500 | 10                    | 10712154   |
|   | 600 | 10                    | 10712164   |



Artikelmgroep: 16.01.05

|  | Buismaat PVC in mm | DN  | Artikelnr. |
|--|--------------------|-----|------------|
| <b>Fig. 102</b><br><b>GY Mofafsluiter voor water</b><br>- geschikt voor PVC buis<br>- drukklasse PN16<br>- epoxy gecoat<br>- vervangbare EPDM afdichtingen<br>- spindel RVS420 | 50                 | 40  | 10720994   |
|  | 63                 | 50  | 10721004   |
|  | 75                 | 65  | 10721014   |
|  | 90                 | 80  | 10721024   |
|  | 110                | 100 | 10721034   |
|  | 125                | 125 | 10721044   |
|  | 140                | 125 | 10721054   |
|  | 160                | 150 | 10721064   |
|  | 200                | 200 | 10721074   |
|  | 250                | 250 | 10721084   |
|  | 315                | 300 | 10721094   |
|  | 400                | 400 | 10721104   |
|  | 500                | 500 | 10721114   |




Artikelmgroep: 16.01.05

|  | Buismaat PE in mm | Artikelnr. |
|--|-------------------|------------|
| <b>Fig. 103</b><br><b>GY Afsluiter met PE spie-einden voor water</b><br>- drukklasse PN16/SDR11<br>- epoxy gecoat<br>- vervangbare EPDM afdichtingen<br>- spindel RVS420 | 63                | 10750034   |
|  | 75                | 10750044   |
|  | 90                | 10750054   |
|  | 110               | 10750064   |
|  | 125               | 10750070   |
|  | 140               | 10750080   |
|  | 160               | 10750090   |
|  | 180               | 10750100   |
|  | 200               | 10750110   |
|  | 225               | 10750120   |
|  | 250               | 10750130   |
|  | 280               | 10750140   |
|  | 315               | 10750150   |
|  | 400               | 10750160   |




Artikelmgroep: 16.01.05


## Gietijzeren afsluiters

|  |   | Afmeting<br>binnendraad | DN | Artikelnr.              |
|--|---|-------------------------|----|-------------------------|
| <b>Fig. 111</b><br><b>GY Dienstafluiters voor water</b><br>- met 2 x binnendraad<br>- rechte uitvoering<br>- drukklasse PN10/16<br>- epoxy gecoat<br>- vervangbare EPDM afdichtingen<br>- spindel RVS420 |  | 3/4"                    | 20 | 10720129                |
|  |   | 1"                      | 25 | 10720130                |
|  |   | 1 1/4"                  | 32 | 10720131                |
|  |   | 1 1/2"                  | 40 | 10720132                |
|  |   | 2"                      | 50 | 10720134                |
|  |   |                         |    | Artikelmgroep: 16.01.05 |


Ook leverbaar met RVS303 of RVS316 spindel.

|  |   | Afmeting<br>buitendraad | Afmeting<br>binnendraad | DN | Artikelnr. |
|--|---|-------------------------|-------------------------|----|------------|
| <b>Fig. 112</b><br><b>GY Dienstafluiters 90° voor water</b><br>- met buitendraad x binnendraad<br>- haakse uitvoering<br>- drukklasse PN10/16<br>- epoxy gecoat<br>- vervangbare EPDM afdichtingen<br>- spindel RVS420 |  | 1 1/4"                  | 1"                      | 25 | 10721162   |
|  |   | 2"                      | 1 1/4"                  | 32 | 10721163   |
|  |   | 2"                      | 1 1/2"                  | 40 | 10721164   |
|  |   | 2"                      | 2"                      | 50 | 10721165   |
|  |   |                         |                         |    |            |


Ook leverbaar met RVS303 of RVS316 spindel.

|   |   | Buismaat PE<br>in mm | DN | Artikelnr. |
|---|---|----------------------|----|------------|
| <b>Fig. 115</b><br><b>GY Dienstafluiters voor water</b><br>- met 2x insteekverbinding voor PE buis<br>- rechte uitvoering<br>- drukklasse PN16<br>- epoxy gecoat<br>- vervangbare EPDM afdichtingen<br>- spindel RVS420 |  | 25                   | 20 | 10720135   |
|   |   | 32                   | 25 | 10720136   |
|   |   | 40                   | 32 | 10720137   |
|   |   | 50                   | 40 | 10720138   |
|   |   | 63                   | 50 | 10720139   |
|   |   |                      |    |            |

Ook leverbaar met RVS303 of RVS316 spindel.

|   |   | Buismaat PE<br>in mm | Afmeting<br>buitendraad | DN | Artikelnr. |
|---|---|----------------------|-------------------------|----|------------|
| <b>Fig. 116</b><br><b>GY Dienstafluiters 90° voor water</b><br>- met buitendraad x insteekverbinding voor PE buis<br>- haakse uitvoering<br>- drukklasse PN10/16<br>- epoxy gecoat<br>- vervangbare EPDM afdichtingen<br>- spindel RVS420 |  | 32                   | 1 1/4"                  | 25 | 10721152   |
|   |   | 40                   | 2"                      | 32 | 10721153   |
|   |   | 50                   | 2"                      | 40 | 10721154   |
|   |   | 63                   | 2"                      | 50 | 10721155   |
|   |   |                      |                         |    |            |

Ook leverbaar met RVS303 of RVS316 spindel.


|   |   | Buismaat PE<br>in mm | Afmeting<br>buitendraad | DN | Artikelnr. |
|---|---|----------------------|-------------------------|----|------------|
| <b>Fig. 117</b><br><b>GY Dienstafluiters voor water</b><br>- met buitendraad x insteekverbinding voor PE buis<br>- rechte uitvoering<br>- drukklasse PN10/16<br>- epoxy gecoat<br>- vervangbare EPDM afdichtingen<br>- spindel RVS420 |  | 32                   | 1"                      | 25 | 10721156   |
|   |   | 40                   | 1 1/4"                  | 32 | 10721157   |
|   |   | 50                   | 1 1/2"                  | 40 | 10721158   |
|   |   | 63                   | 2"                      | 50 | 10721159   |
|   |   |                      |                         |    |            |

Ook leverbaar met RVS303 of RVS316 spindel.

# 16.01 Fucoli programma


## Toebehoren voor gietijzeren afsluiters

- Met KIWA-keur (waar van toepassing).


|  | DN/afmeting  | Artikelnr.             |
|--|--|------------------------|
| <b>Fig. 122</b><br>Handwiel<br> | 20- <sup>3</sup> / <sub>4</sub> " / 25-1" / 32-1 <sup>1</sup> / <sub>4</sub> " / |                        |
|  | 40-1 <sup>1</sup> / <sub>2</sub> " / 50-2"                                       | 10709500               |
|  | 40 / 50  | 10709510               |
|  | 65 / 80  | 10709520               |
|  | 100  | 10709525               |
|  | 125 / 150  | 10709530               |
|  | 200  | 10709540               |
|  | 250  | 10709440               |
|  | 300  | 10709535               |
|  | 350 / 400  | 10709545               |
|  | 450 / 500  | 10709490               |
|  | 600  | 10709515               |
|  |  | Artikelgroep: 16.01.10 |

|   | DN/afmeting  | Artikelnr.             |
|---|--|------------------------|
| <b>Fig. 123</b><br>Nok<br>- kleur: blauw<br> | 20- <sup>3</sup> / <sub>4</sub> " / 25-1" / 32-1 <sup>1</sup> / <sub>4</sub> " / |                        |
|   | 40 -1 <sup>1</sup> / <sub>2</sub> " / 50-2"                                      | 10707410               |
|   | 40 / 50  | 10707411               |
|   | 65 / 80  | 10707412               |
|   | 100 / 125 / 150  | 10707413               |
|   | 200  | 10707414               |
|   | 250 / 300  | 10707415               |
|   | 350 / 400 / 450 / 500  | 10707416               |
| <b>Fig. 127</b><br>Nok<br>- kleur: geel   | 25/150   | 10737350               |
|   | 200/300  | 10737353               |
|   |  | Artikelgroep: 16.01.10 |

|  | DN/afmeting  | Artikelnr. |
|--|--|------------|
| <b>Fig. 124</b><br>Inbouwgarmituur<br> | L = 650mm  |            |
|  | 20- <sup>3</sup> / <sub>4</sub> " / 25-1" / 32-1 <sup>1</sup> / <sub>4</sub> " / |            |
|  | 40 -1 <sup>1</sup> / <sub>2</sub> " / 50-2"                                      | 10703270   |
|  | 40 / 50  | 10703252   |
|  | 65 / 80  | 10703254   |
|  | 100  | 10703258   |
|  | 125 / 150  | 10703262   |
|  | 200  | 10703264   |
|  | 250 / 300  | 10703266   |
|  | 350 / 400 / 450 / 500  | 10703275   |
|  | L = 1000mm   |            |
|  | 20- <sup>3</sup> / <sub>4</sub> " / 25-1" / 32-1 <sup>1</sup> / <sub>4</sub> " / |            |
|  | 40 -1 <sup>1</sup> / <sub>2</sub> " / 50-2"                                      | 10703360   |
|  | 40 / 50  | 10703365   |
|  | 65 / 80  | 10703370   |
|  | 100  | 10703375   |
|  | 125 / 150  | 10703380   |
|  | 200  | 10703385   |
|  | 250 / 300  | 10703390   |
| 350 / 400 / 450 / 500  | 10703395   |            |
|  | Artikelgroep: 16.01.10   |            |

|  | Afmeting   | Artikelnr.             |
|--|------------|------------------------|
| <b>Fig. 134</b><br>T-sleutel<br> | Universeel | 2311                   |
|  |            | Artikelgroep: 16.01.10 |

## Gietijzeren balkeerkleppen

|  | DN/afmeting                          | Artikelnr.             |
|--|--------------------------------------|------------------------|
| <b>Fig. 165</b><br>GY Balkeerklep voor water<br>- binnendraad x binnendraad<br>- drukklasse PN16<br>- epoxy gecoat<br>- metaal met rubber beklede bal<br> | 32 / 1 <sup>1</sup> / <sub>4</sub> " | 10763514               |
|  | 40 / 1 <sup>1</sup> / <sub>2</sub> " | 10763524               |
|  | 50 / 2"                              | 10763534               |
|  |                                      | Artikelgroep: 16.01.10 |

## Gietijzeren balkeerkleppen

|  | DN  | Geboord/drukklasse PN | Artikelnr. |                        |
|--|-----|-----------------------|------------|------------------------|
| <b>Fig. 166</b><br><b>GY Balkeerklep voor water</b><br>- met flensverbindingen<br>- epoxy gecoat $\geq 250 \mu\text{m}$<br>- metaal met rubber beklede bal | 40  | 10/16                 | 10763544   |                        |
|  | 50  | 10/16                 | 10763554   |                        |
|  | 65  | 10/16                 | 10763574   |                        |
|  | 80  | 10/16                 | 10763584   |                        |
|  | 100 | 10/16                 | 10763594   |                        |
|  | 125 | 10/16                 | 10763604   |                        |
|  | 150 | 10/16                 | 10763614   |                        |
|  | 200 | 10                    | 10763624   |                        |
|  | 250 | 10                    | 10763634   |                        |
|  | 300 | 10                    | 10763644   |                        |
|  | 400 | 10                    | 10763664   |                        |
|  |     |                       |            | Artikelgroep: 16.01.10 |

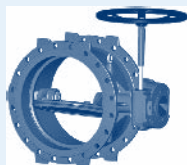


|  | DN/afmeting            | Artikelnr. |
|--|------------------------|------------|
| <b>Fig. 169</b><br><b>Demontagesleutel</b><br>- sleutel om eenvoudig de bal te verwijderen terwijl de balkeerklep in horizontale positie kan blijven staan | DN40 / 1 1/4" / 1 1/2" | 10763744   |
|  | DN50 / 2"              | 10763754   |
|  | DN65                   | 10763764   |
|  | DN80                   | 10763784   |
|  | DN100                  | 10763804   |
|  | DN125                  | 10763804   |
|  | DN150                  | 10763814   |
|  | DN200                  | 10763824   |
|  | DN250                  | 10763834   |
|  | DN300                  | 10763844   |
|  |                        |            |



## Gietijzeren vlinderkleppen

|   | DN   | Geboord/drukklasse PN | Artikelnr.             |
|---|------|-----------------------|------------------------|
| <b>Fig. 170</b><br><b>GY Vlinderklep met zitting voor water</b><br>- epoxy gecoat $\geq 250 \mu\text{m}$<br>- vervangbare EPDM afdichtingen<br>- zitting RVS 304 of RVS 316 op aanvraag | 150  | 10/16                 | 10770010               |
|   | 200  | 16                    | 10771020               |
|   | 250  | 16                    | 10771030               |
|   | 300  | 16                    | 10771040               |
|   | 350  | 16                    | 10771050               |
|   | 400  | 16                    | 10771060               |
|   | 450  | 16                    | 10771070               |
|   | 500  | 16                    | 10771080               |
|   | 600  | 16                    | 10771100               |
|   | 700  | 16                    | 10771120               |
|   | 800  | 16                    | 10771140               |
|   | 900  | 16                    | 10771160               |
|   | 1000 | 16                    | 10771180               |
|   | 1200 | 16                    | 10771220               |
|   | 200  | 10                    | 10770020               |
|   | 250  | 10                    | 10770030               |
|   | 300  | 10                    | 10770040               |
|   | 350  | 10                    | 10770050               |
|   | 400  | 10                    | 10770060               |
|   | 450  | 10                    | 10770070               |
|   | 500  | 10                    | 10770080               |
|   | 600  | 10                    | 10770100               |
|   | 700  | 10                    | 10770120               |
|   | 800  | 10                    | 10770140               |
| 900   | 10   | 10770160              |                        |
| 1000  | 10   | 10770180              |                        |
| 1200  | 10   | 10770220              |                        |
|   |      |                       | Artikelgroep: 16.01.10 |



Ook leverbaar met NBR afdichtingen.

# 16.01 Fucoli programma

## Gietijzeren vlinderkleppen

|   | DN  | Geboord/drukklasse PN | Artikelnr. |
|---|-----|-----------------------|------------|
| <b>Fig. 174</b><br><b>GY Vlinderklep met handle voor water</b><br>- vlinder RVS316<br>- huis GG25 Rislán<br>- afdichting: EPDM* | 40  | 10/16                 | 2730040    |
|   | 50  | 10/16                 | 2730050    |
|   | 65  | 10/16                 | 2730065    |
|   | 80  | 10/16                 | 2730080    |
|   | 100 | 10/16                 | 2730100    |
|   | 125 | 10/16                 | 2730125    |
|   | 150 | 10/16                 | 2730150    |
|   | 200 | 10/16                 | 2730200    |
|   | 250 | 10                    | 2730250    |
|   | 300 | 10                    | 2730300    |
|   |     |                       |            |



\* Ook leverbaar met NBR afdichtingen.

Voor afstandbediende vlinderkleppen verwijzen wij u naar Groep 4 'afstandbediende afsluiters'.



## Straatpotten en toebehoren

|   | Afmeting in mm<br>Ø buiten onderzijde | Afmeting in mm<br>buiten bovenzijde | Artikelnr.             |
|---|---------------------------------------|-------------------------------------|------------------------|
| <b>Fig. 130</b><br><b>Afsluiter straatpot</b> | 200                                   | 145 x 145                           | 9537                   |
|   | 270                                   | 190 x 190                           | 9535                   |
|   | 420                                   | 375 x 260                           | 9536                   |
|   |                                       |                                     | Artikelgroep: 16.01.10 |



|  | Artikelnr.             |
|--|------------------------|
| <b>Fig. 130.1</b><br><b>Tussenstuk</b><br>- voor ophogen<br>straatpot 9535 | 95355                  |
|  | Artikelgroep: 16.01.10 |



|  | Type       | Voor type straatpot | Artikelnr.             |
|--|------------|---------------------|------------------------|
| <b>Fig. 131</b><br><b>Betonnen Boventegel voor straatpot</b> | Klein      | 9537                | 95371                  |
|  | Groot      | 9535                | 95351                  |
|  | Brandkraan | 9536                | 95361                  |
|  |            |                     | Artikelgroep: 16.01.10 |



|  | Type        | Voor type straatpot | Artikelnr.             |
|--|-------------|---------------------|------------------------|
| <b>Fig. 132</b><br><b>Kunststof Onderlegtegel voor straatpot</b> | Rond        | 9535 + 9537         | 95372                  |
|  | Rechthoekig | 9536                | 95362                  |
|  |             |                     | Artikelgroep: 16.01.10 |



|  | Opschrift  | Kleur | Artikelnr.             |
|--|------------|-------|------------------------|
| <b>Fig. 133</b><br><b>Plaatje voor straatpot</b> | Gas        | geel  | 23101                  |
|  | Water      | blauw | 23102                  |
|  | Riool      | groen | 23103                  |
|  | Peilbuis   | geel  | 23104                  |
|  | Brandkraan | rood  | 23105                  |
|  |            |       | Artikelgroep: 16.01.10 |



## Gietijzeren fittingen

**Fig. 150**

**GY Trekvaste koppeling GFIX® voor water**

- voor het verbinden van buizen van verschillende materialen: PVC / PE / staal / gietijzer / glasvezel versterkt en AC
- GFIX® gripsysteem (trekvast)
- voor gebruik i.c.m. PE buizen, adviseren wij u om RVS steunbussen toe te passen



| Afmeting in mm<br>min. / max. | Artikelnr. |
|-------------------------------|------------|
| 39 / 52                       | 10900400   |
| 49 / 64                       | 10900401   |
| 63 / 83                       | 10900402   |
| 72 / 93                       | 10900424   |
| 78 / 103                      | 10900403   |
| 87 / 117                      | 10900404   |
| 100 / 130                     | 10900405   |
| 117 / 147                     | 10900406   |
| 138 / 168                     | 10900407   |
| 152 / 182                     | 10900408   |
| 172 / 202                     | 10900409   |
| 198 / 228                     | 10900410   |
| 217 / 257                     | 10900411   |
| 245 / 285                     | 10900412   |
| 300 / 340                     | 10900413   |
| 340 / 380                     | 10900414   |
| 390 / 430                     | 10900415   |
| 420 / 460                     | 10900417   |
| 450 / 490                     | 10900418   |
| 492 / 532                     | 10900419   |
| 508 / 548                     | 10900420   |
| 532 / 572                     | 10900421   |
| 605 / 645                     | 10900422   |
| 660 / 700                     | 10900423   |

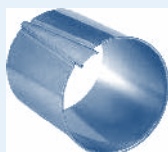
Artikelgroep: 16.01.10

| DN   | Afmeting in mm<br>min./max. | Geboord/drukklasse PN | Artikelnr. |
|--|-----------------------------|-----------------------|------------|
| <b>Fig. 154</b>  |                             |                       |            |
| <b>GY Trekvast E-stuk GFIX® voor water</b>   |                             |                       |            |
| - voor het verbinden van buizen van verschillende materialen: PVC / PE / staal / gietijzer / glasvezel versterkt en AC | 50                          | 10/16                 | 10900500   |
| - GFIX® gripsysteem (trekvast)   | 50                          | 10/16                 | 10900501   |
| - voor gebruik i.c.m. PE buizen, adviseren wij u om RVS steunbussen toe te passen                                      | 65                          | 10/16                 | 10900502   |
|  | 80                          | 10/16                 | 10900503   |
|  | 80/100                      | 10/16                 | 10900504   |
|  | 100                         | 10/16                 | 10900505   |
|  | 125                         | 10/16                 | 10900506   |
|  | 150                         | 10/16                 | 10900507   |
|  | 200                         | 10/16                 | 10900508   |
|  | 250                         | 10/16                 | 10900509   |
|  | 300                         | 10/16                 | 10900510   |
|  | 350                         | 10/16                 | 10900511   |
|  | 400                         | 10                    | 10900513   |
|  | 400                         | 16                    | 10900514   |
|  | 450                         | 10                    | 10900515   |
|  | 500                         | 10                    | 10900517   |
|  | 500                         | 10                    | 10900519   |
|  | 600                         | 10                    | 10900521   |



Artikelgroep: 16.01.10

| Buismaat in mm                                       | Artikelnr. SDR17 Fig. 155 | Artikelnr. SDR11 Fig. 255 |
|--|---------------------------|---------------------------|
| <b>Fig. 155/255</b>                                  |                           |                           |
| <b>RVS Steunbus</b>                                  |                           |                           |
| - voor toepassing in combinatie met PE buizen        | 63                        | ISO063038                 |
| - RVS304 (RVS316 op aanvraag)                        | 75                        | ISO075045                 |
| - inclusief wig, voor eenvoudige montage / demontage | 90                        | ISO090054                 |
| - voor PE buis SDR17 en SDR11 (SDR13,6 op aanvraag)  | 110                       | ISO110066                 |
|  | 125                       | ISO125074                 |
|  | 140                       | ISO140083                 |
|  | 160                       | ISO160095                 |
|  | 180                       | ISO180107                 |
|  | 200                       | ISO200119                 |
|  | 225                       | ISO225134                 |
|  | 250                       | ISO250148                 |
|  | 280                       | ISO280166                 |
|  | 315                       | ISO315187                 |
|  | 355                       | ISO355211                 |
|  | 400                       | ISO400237                 |
|  | 450                       | ISO450267                 |
|  | 500                       | ISO500297                 |
|  | 560                       | ISO560332                 |
|  | 630                       | ISO630374                 |
|  | 710                       | ISO710421                 |



Artikelgroep: 16.01.10



# 16.01 Fucoli programma

## Gietijzeren fittingen

**Fig. 157**

GY Inbouwstuk / passtuk voor water



| DN   | Geboord/drukklasse<br>PN | Artikelnr. |
|------|--------------------------|------------|
| 40   | 10/16                    | 10101001   |
| 50   | 10/16                    | 10101002   |
| 65   | 10/16                    | 10101004   |
| 80   | 10/16                    | 10101005   |
| 100  | 10/16                    | 10101006   |
| 125  | 10/16                    | 10101007   |
| 150  | 10/16                    | 10101008   |
| 200  | 10                       | 10101009   |
| 250  | 10                       | 10101010   |
| 300  | 10                       | 10101011   |
| 350  | 10                       | 10101012   |
| 400  | 10                       | 10101013   |
| 450  | 10                       | 10101014   |
| 500  | 10                       | 10101015   |
| 600  | 10                       | 10101016   |
| 700  | 10                       | 10101017   |
| 800  | 10                       | 10101018   |
| 900  | 10                       | 10101019   |
| 1000 | 10                       | 10101020   |

Artikelgroep: 16.01.10

**Fig. 180**

GY Aanboorzadel voor water

- epoxy gecoat
- drukkklasse PN16
- voor PE en PVC leidingen



| Buismaat in mm | Afmeting | Artikelnr. |
|----------------|----------|------------|
| 50             | 3/4"     | 10480011   |
|                | 1"       | 10480012   |
|                | 1 1/4"   | 10480013   |
|                | 1 1/2"   | 10480014   |
| 63             | 3/4"     | 10480021   |
|                | 1"       | 10480022   |
|                | 1 1/4"   | 10480023   |
|                | 1 1/2"   | 10480024   |
|                | 2"       | 10480025   |
| 75             | 3/4"     | 10480031   |
|                | 1"       | 10480032   |
|                | 1 1/4"   | 10480033   |
|                | 1 1/2"   | 10480034   |
|                | 2"       | 10480035   |
| 90             | 3/4"     | 10480041   |
|                | 1"       | 10480042   |
|                | 1 1/4"   | 10480043   |
|                | 1 1/2"   | 10480044   |
|                | 2"       | 10480045   |
|                | 2 1/2"   | 10480046   |
| 110            | 3/4"     | 10480051   |
|                | 1"       | 10480052   |
|                | 1 1/4"   | 10480053   |
|                | 1 1/2"   | 10480054   |
|                | 2"       | 10480055   |
|                | 2 1/2"   | 10480056   |
|                | 3"       | 10480057   |
|                | 3 1/2"   | 10480058   |
| 125            | 3/4"     | 10480061   |
|                | 1"       | 10480062   |
|                | 1 1/4"   | 10480063   |
|                | 1 1/2"   | 10480064   |
|                | 2"       | 10480065   |
|                | 2 1/2"   | 10480066   |
|                | 3"       | 10480067   |
|                | 3 1/2"   | 10480068   |
| 140            | 3/4"     | 10480071   |
|                | 1"       | 10480072   |
|                | 1 1/4"   | 10480073   |
|                | 1 1/2"   | 10480074   |
|                | 2"       | 10480075   |
|                | 2 1/2"   | 10480076   |
|                | 3"       | 10480077   |
|                | 3 1/2"   | 10480078   |

↗

## Gietijzeren fittingen

|                         | Buismaat in mm | Afmeting | Artikelnr. |
|-------------------------|----------------|----------|------------|
| <b>Vervolg Fig. 180</b> | 160            | 3/4"     | 10480081   |
|                         |                | 1"       | 10480082   |
|                         |                | 1 1/4"   | 10480083   |
|                         |                | 1 1/2"   | 10480084   |
|                         |                | 2"       | 10480085   |
|                         |                | 2 1/2"   | 10480086   |
|                         |                | 3"       | 10480087   |
|                         | 200            | 3/4"     | 10480091   |
|                         |                | 1"       | 10480092   |
|                         |                | 1 1/4"   | 10480093   |
|                         |                | 1 1/2"   | 10480094   |
|                         |                | 2"       | 10480095   |
|                         |                | 2 1/2"   | 10480096   |
|                         |                | 3"       | 10480097   |
|                         | 225            | 3/4"     | 10480103   |
|                         |                | 1"       | 10480104   |
|                         |                | 1 1/4"   | 10480105   |
|                         |                | 1 1/2"   | 10480106   |
|                         |                | 2"       | 10480107   |
|                         |                | 2 1/2"   | 10480108   |
|                         |                | 3"       | 10480109   |
|                         | 250            | 3/4"     | 10480111   |
|                         |                | 1"       | 10480112   |
|                         |                | 1 1/4"   | 10480113   |
|                         |                | 1 1/2"   | 10480114   |
|                         |                | 2"       | 10480115   |
|                         |                | 2 1/2"   | 10480116   |
| 3"                      |                | 10480117 |            |
| 280                     | 3/4"           | 10480123 |            |
|                         | 1"             | 10480124 |            |
|                         | 1 1/4"         | 10480125 |            |
|                         | 1 1/2"         | 10480126 |            |
|                         | 2"             | 10480127 |            |
|                         | 2 1/2"         | 10480128 |            |
|                         | 3"             | 10480129 |            |
| 315                     | 3/4"           | 10480131 |            |
|                         | 1"             | 10480132 |            |
|                         | 1 1/4"         | 10480133 |            |
|                         | 1 1/2"         | 10480134 |            |
|                         | 2"             | 10480135 |            |
|                         | 2 1/2"         | 10480136 |            |
|                         | 3"             | 10480137 |            |
| 400                     | 3/4"           | 10480151 |            |
|                         | 1"             | 10480152 |            |
|                         | 1 1/4"         | 10480153 |            |
|                         | 1 1/2"         | 10480154 |            |
|                         | 2"             | 10480155 |            |
|                         | 2 1/2"         | 10480157 |            |
|                         | 3"             | 10480156 |            |

Artikelgroep: 16.01.10

16

### Fig. 183

#### Adapter voor GY aanboorzadel

- buitendraad x binnendraad
- epoxy gecoat
- verloop adapter voor aanboorzadels 2"



| Buitendraad | Binnendraad | Artikelnr. |
|-------------|-------------|------------|
| 2"          | 1/2"        | 10480460   |
| 2"          | 3/4"        | 10480461   |
| 2"          | 1"          | 10480462   |
| 2"          | 1 1/4"      | 10480463   |
| 2"          | 1 1/2"      | 10480464   |
| 2"          | 2"          | 10480465   |
| Afsluitmes  |             | 10480466   |

Artikelgroep: 16.01.10

# 16.01 Fucoli programma

## Gietijzeren fittingen

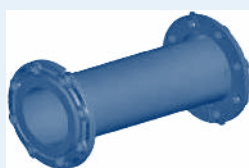
|                                    | Buismaat in mm | DN  | Geboord/drukklasse PN | Artikelnr. |
|------------------------------------|----------------|-----|-----------------------|------------|
| <b>Fig. 189</b>                    | 63             | 50  | 10/16                 | 10132005   |
| <b>GY Adapterflens voor water</b>  | 63             | 65  | 10/16                 | 10132010   |
| - epoxy gecoat                     | 75             | 65  | 10/16                 | 10132015   |
| - geschikt voor PE en PVC buis     | 90             | 80  | 10/16                 | 10132020   |
| - voor PE buis steunbus gebruiken, | 90             | 100 | 10/16                 | 10132025   |
| zie blz. 231 Fig. 155/255          | 110            | 100 | 10/16                 | 10132030   |
|                                    | 125            | 125 | 10/16                 | 10132035   |
|                                    | 140            | 125 | 10/16                 | 10132040   |
|                                    | 160            | 150 | 10/16                 | 10132045   |
|                                    | 200            | 200 | 10                    | 10132050   |
|                                    | 225            | 200 | 10                    | 10132055   |
|                                    | 250            | 250 | 10                    | 10132060   |
|                                    | 280            | 250 | 10                    | 10132065   |
|                                    | 315            | 300 | 10                    | 10132070   |
|                                    | 400            | 400 | 10                    | 10132075   |
|                                    | 500            | 500 | 10                    | 10132080   |

Artikelgroep: 16.01.10



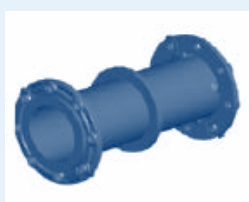
|                                     | DN  | Lengte in mm | Geboord/drukklasse PN | Artikelnr. |
|-------------------------------------|-----|--------------|-----------------------|------------|
| <b>Fig. 300</b>                     | 40  | 250          | 10/16                 | 40207010   |
| <b>GY Flensbuis FF voor water</b>   | 50  | 250          | 10/16                 | 40207020   |
| - epoxy gecoat                      | 65  | 250          | 10/16                 | 40207040   |
| - met twee-delige draaibare flenzen | 80  | 250          | 10/16                 | 40207050   |
| - draaibare flenzen verkorten de    | 100 | 250          | 10/16                 | 40207060   |
| montagetijd                         | 125 | 250          | 10/16                 | 40207070   |
|                                     | 150 | 250          | 10/16                 | 40207080   |
|                                     | 200 | 250          | 10/16                 | 40207090   |
|                                     | 250 | 250          | 10                    | 40207100   |
|                                     | 300 | 250          | 10                    | 40207110   |
|                                     | 40  | 500          | 10/16                 | 40209011   |
|                                     | 50  | 500          | 10/16                 | 40209020   |
|                                     | 65  | 500          | 10/16                 | 40209040   |
|                                     | 80  | 500          | 10/16                 | 40209050   |
|                                     | 100 | 500          | 10/16                 | 40209060   |
|                                     | 125 | 500          | 10/16                 | 40209070   |
|                                     | 150 | 500          | 10/16                 | 40209080   |
|                                     | 200 | 500          | 10/16                 | 40209090   |
|                                     | 250 | 500          | 10                    | 40209100   |
|                                     | 250 | 500          | 16                    | 40209105   |
|                                     | 300 | 500          | 10                    | 40209110   |
|                                     | 300 | 500          | 16                    | 40209115   |
|                                     | 400 | 500          | 10                    | 40209120   |
|                                     | 400 | 500          | 16                    | 40209125   |
|                                     | 500 | 500          | 10                    | 40209130   |
|                                     | 500 | 500          | 16                    | 40209135   |

Artikelgroep: 16.01.10



|                                    | DN  | Lengte | Geboord/drukklasse PN | Artikelnr. |
|------------------------------------|-----|--------|-----------------------|------------|
| <b>Fig. 301</b>                    | 40  | 500    | 10/16                 | 40215010   |
| <b>GY Flensbuis met</b>            | 50  | 500    | 10/16                 | 40215020   |
| <b>instortflens FFM voor water</b> | 65  | 500    | 10/16                 | 40215040   |
|                                    | 80  | 500    | 10/16                 | 40215050   |
|                                    | 100 | 500    | 10/16                 | 40215060   |
|                                    | 125 | 500    | 10/16                 | 40215070   |
|                                    | 150 | 500    | 10/16                 | 40215080   |
|                                    | 200 | 500    | 10/16                 | 40215090   |
|                                    | 250 | 500    | 10                    | 40215100   |
|                                    | 300 | 500    | 10                    | 40215110   |
|                                    | 400 | 500    | 10                    | 40215120   |
|                                    | 500 | 500    | 10                    | 40215130   |

Artikelgroep: 16.01.10



## Gietijzeren fittingen

|  | DN  | Geboord/drukklasse<br>PN | Artikelnr.             |
|--|-----|--------------------------|------------------------|
| <b>Fig. 305</b><br><b>GY Bocht 11° FFK voor water</b><br>- epoxy gecoat<br>- in de maten DN40 t/m DN600 met twee-delige draaibare flenzen<br>- draaibare flenzen verkorten de montagetijd<br>- vanaf de maat DN700 met vaste flenzen | 40  | 10/16                    | 10004010               |
|  | 50  | 10/16                    | 10004020               |
|  | 65  | 10/16                    | 10004040               |
|  | 80  | 10/16                    | 10004050               |
|  | 100 | 10/16                    | 10004060               |
|  | 125 | 10/16                    | 10004070               |
|  | 150 | 10/16                    | 10004080               |
|  | 200 | 10/16                    | 10004090               |
|  | 250 | 10                       | 10004100               |
|  | 300 | 10                       | 10004110               |
|  | 350 | 10                       | 10004112               |
|  | 400 | 10                       | 10004120               |
|  | 450 | 10                       | 10004130               |
|  | 500 | 10                       | 10004150               |
|  | 600 | 10                       | 10004160               |
|  | 700 | 10                       | 10121150               |
|  | 800 | 10                       | 10121160               |
| 900  | 10  | 10121170                 |                        |
| 1000   | 10  | 10121180                 |                        |
|  |     |                          | Artikelgroep: 16.01.10 |



|  | DN  | Geboord/drukklasse<br>PN | Artikelnr.             |
|--|-----|--------------------------|------------------------|
| <b>Fig. 306</b><br><b>GY Bocht 22° FFK voor water</b><br>- epoxy gecoat<br>- in de maten DN40 t/m DN600 met twee-delige draaibare flenzen<br>- draaibare flenzen verkorten de montagetijd<br>- vanaf de maat DN700 met vaste flenzen | 40  | 10/16                    | 10002010               |
|  | 50  | 10/16                    | 10002020               |
|  | 65  | 10/16                    | 10002040               |
|  | 80  | 10/16                    | 10002050               |
|  | 100 | 10/16                    | 10002060               |
|  | 125 | 10/16                    | 10002070               |
|  | 150 | 10/16                    | 10002080               |
|  | 200 | 10/16                    | 10002090               |
|  | 250 | 10                       | 10002100               |
|  | 300 | 10                       | 10002110               |
|  | 350 | 10                       | 10002112               |
|  | 400 | 10                       | 10002120               |
|  | 450 | 10                       | 10002130               |
|  | 500 | 10                       | 10002150               |
|  | 600 | 10                       | 10002180               |
|  | 700 | 10                       | 10118150               |
|  | 800 | 10                       | 10118160               |
| 900  | 10  | 10118170                 |                        |
| 1000   | 10  | 10118180                 |                        |
|  |     |                          | Artikelgroep: 16.01.10 |



|  | DN  | Geboord/drukklasse<br>PN | Artikelnr.             |
|--|-----|--------------------------|------------------------|
| <b>Fig. 308</b><br><b>GY Bocht 45° FFK voor water</b><br>- epoxy gecoat<br>- in de maten DN40 t/m DN600 met twee-delige draaibare flenzen<br>- draaibare flenzen verkorten de montagetijd<br>- vanaf de maat DN700 met vaste flenzen | 40  | 10/16                    | 10003010               |
|  | 50  | 10/16                    | 10003020               |
|  | 65  | 10/16                    | 10003040               |
|  | 80  | 10/16                    | 10003050               |
|  | 100 | 10/16                    | 10003060               |
|  | 125 | 10/16                    | 10003070               |
|  | 150 | 10/16                    | 10003080               |
|  | 200 | 10/16                    | 10003090               |
|  | 250 | 10                       | 10003100               |
|  | 300 | 10                       | 10003110               |
|  | 350 | 10                       | 10003112               |
|  | 400 | 10                       | 10003120               |
|  | 450 | 10                       | 10003130               |
|  | 500 | 10                       | 10003140               |
|  | 600 | 10                       | 10003150               |
|  | 700 | 10                       | 10115150               |
|  | 800 | 10                       | 10115160               |
| 900  | 10  | 10115170                 |                        |
| 1000   | 10  | 10115180                 |                        |
|  |     |                          | Artikelgroep: 16.01.10 |



# 16.01 Fucoli programma

## Gietijzeren fittingen

**Fig. 312**

**GY Bocht 90° FFQ voor water**

- epoxy gecoat
- in de maten DN40 t/m DN600 met twee-delige draaibare flenzen
- draaibare flenzen verkorten de montagetijd
- vanaf de maat DN700 met vaste flenzen



| DN   | Geboord/drukklasse<br>PN | Artikelnr. |
|------|--------------------------|------------|
| 40   | 10/16                    | 10001019   |
| 50   | 10/16                    | 10001020   |
| 65   | 10/16                    | 10001040   |
| 80   | 10/16                    | 10001050   |
| 100  | 10/16                    | 10001060   |
| 125  | 10/16                    | 10001070   |
| 150  | 10/16                    | 10001075   |
| 200  | 10/16                    | 10001085   |
| 250  | 10                       | 10001090   |
| 300  | 10                       | 10001095   |
| 350  | 10                       | 10001098   |
| 400  | 10                       | 10001120   |
| 450  | 10                       | 10001130   |
| 500  | 10                       | 10001170   |
| 600  | 10                       | 10001180   |
| 700  | 10                       | 10112150   |
| 800  | 10                       | 10112160   |
| 900  | 10                       | 10112170   |
| 1000 | 10                       | 10112180   |

Artikelgroep: 16.01.10

**Fig. 320**

**GY T-stuk FFT voor water**

- epoxy gecoat
- in de maten DN40 t/m DN600 met twee-delige draaibare flenzen
- draaibare flenzen verkorten de montagetijd
- vanaf de maat DN700 met vaste flenzen



| DN              | Geboord/drukklasse<br>PN | Artikelnr. |
|-----------------|--------------------------|------------|
| 40 x 40 x 40    | 10/16                    | 10020019   |
| 50 x 40 x 50    | 10/16                    | 10020015   |
| 50 x 50 x 50    | 10/16                    | 10020020   |
| 65 x 40 x 65    | 10/16                    | 10020014   |
| 65 x 50 x 65    | 10/16                    | 10020036   |
| 65 x 65 x 65    | 10/16                    | 10020040   |
| 80 x 40 x 80    | 10/16                    | 10020017   |
| 80 x 50 x 80    | 10/16                    | 10020044   |
| 80 x 65 x 80    | 10/16                    | 10020048   |
| 80 x 80 x 80    | 10/16                    | 10020050   |
| 100 x 40 x 100  | 10/16                    | 10020018   |
| 100 x 50 x 100  | 10/16                    | 10020052   |
| 100 x 65 x 100  | 10/16                    | 10020056   |
| 100 x 80 x 100  | 10/16                    | 10020058   |
| 100 x 100 x 100 | 10/16                    | 10020060   |
| 125 x 40 x 125  | 10/16                    | 10020059   |
| 125 x 50 x 125  | 10/16                    | 10020061   |
| 125 x 65 x 125  | 10/16                    | 10020064   |
| 125 x 80 x 125  | 10/16                    | 10020066   |
| 125 x 100 x 125 | 10/16                    | 10020068   |
| 125 x 125 x 125 | 10/16                    | 10020070   |
| 150 x 40 x 150  | 10/16                    | 10020077   |
| 150 x 50 x 150  | 10/16                    | 10020078   |
| 150 x 65 x 150  | 10/16                    | 10020082   |
| 150 x 80 x 150  | 10/16                    | 10020084   |
| 150 x 100 x 150 | 10/16                    | 10020086   |
| 150 x 125 x 150 | 10/16                    | 10020088   |
| 150 x 150 x 150 | 10/16                    | 10020090   |
| 200 x 40 x 200  | 10/16                    | 10020091   |
| 200 x 50 x 200  | 10/16                    | 10020092   |
| 200 x 65 x 200  | 10/16                    | 10020096   |
| 200 x 80 x 200  | 10/16                    | 10020098   |
| 200 x 100 x 200 | 10/16                    | 10020100   |
| 200 x 125 x 200 | 10/16                    | 10020102   |
| 200 x 150 x 200 | 10/16                    | 10020104   |
| 200 x 200 x 200 | 10/16                    | 10020106   |
| 250 x 40 x 250  | 10                       | 10020110   |
| 250 x 50 x 250  | 10                       | 10020112   |
| 250 x 65 x 250  | 10                       | 10020116   |
| 250 x 80 x 250  | 10                       | 10020118   |
| 250 x 100 x 250 | 10                       | 10020120   |
| 250 x 125 x 250 | 10                       | 10020122   |
| 250 x 150 x 250 | 10                       | 10020124   |
| 250 x 200 x 250 | 10                       | 10020126 ↗ |

## Gietijzeren fittingen

| DN                      | Geboord/drukklasse<br>PN | Artikelnr. |
|-------------------------|--------------------------|------------|
| <b>Vervolg Fig. 320</b> |                          |            |
| 250 x 250 x 250         | 10                       | 10020128   |
| 300 x 40 x 300          | 10                       | 10020134   |
| 300 x 50 x 300          | 10                       | 10020136   |
| 300 x 65 x 300          | 10                       | 10020140   |
| 300 x 80 x 300          | 10                       | 10020142   |
| 300 x 100 x 300         | 10                       | 10020144   |
| 300 x 125 x 300         | 10                       | 10020146   |
| 300 x 150 x 300         | 10                       | 10020148   |
| 300 x 200 x 300         | 10                       | 10020150   |
| 300 x 250 x 300         | 10                       | 10020152   |
| 300 x 300 x 300         | 10                       | 10020154   |
| 350 x 80 x 350          | 10                       | 10020183   |
| 350 x 100 x 350         | 10                       | 10020158   |
| 350 x 125 x 350         | 10                       | 10020184   |
| 350 x 150 x 350         | 10                       | 10020160   |
| 350 x 200 x 350         | 10                       | 10020178   |
| 350 x 250 x 350         | 10                       | 10020194   |
| 350 x 300 x 350         | 10                       | 10020186   |
| 350 x 350 x 350         | 10                       | 10020156   |
| 400 x 80 x 400          | 10                       | 10020162   |
| 400 x 100 x 400         | 10                       | 10020164   |
| 400 x 125 x 400         | 10                       | 10020166   |
| 400 x 150 x 400         | 10                       | 10020168   |
| 400 x 200 x 400         | 10                       | 10020174   |
| 400 x 250 x 400         | 10                       | 10020170   |
| 400 x 300 x 400         | 10                       | 10020172   |
| 400 x 350 x 400         | 10                       | 10020188   |
| 400 x 400 x 400         | 10                       | 10020176   |
| 450 x 100 x 450         | 10                       | 10020198   |
| 450 x 450 x 450         | 10                       | 10020216   |
| 500 x 100 x 500         | 10                       | 10020218   |
| 500 x 150 x 500         | 10                       | 10020222   |
| 500 x 200 x 500         | 10                       | 10020224   |
| 500 x 250 x 500         | 10                       | 10020226   |
| 500 x 300 x 500         | 10                       | 10020228   |
| 500 x 400 x 500         | 10                       | 10020232   |
| 500 x 500 x 500         | 10                       | 10020234   |
| 600 x 100 x 600         | 10                       | 10020246   |
| 600 x 150 x 600         | 10                       | 10020250   |
| 600 x 200 x 600         | 10                       | 10020252   |
| 600 x 250 x 600         | 10                       | 10020254   |
| 600 x 300 x 600         | 10                       | 10020256   |
| 600 x 400 x 600         | 10                       | 10020260   |
| 600 x 500 x 600         | 10                       | 10020262   |
| 600 x 600 x 600         | 10                       | 10020264   |
| 700 x 700 x 700         | 10                       | 10140000   |
| 800 x 800 x 800         | 10                       | 10140125   |
| 900 x 900 x 900         | 10                       | 10140250   |
| 1000 x 1000 x 1000      | 10                       | 10140375   |

Artikelgroep: 16.01.10

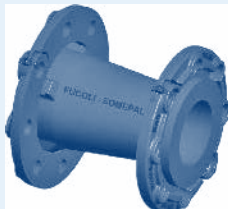
# 16.01 Fucoli programma

## Gietijzeren fittingen

**Fig. 325**

**GY Verloopstuk FFR voor water**

- epoxy gecoat
- in de maten DN40 t/m DN600 met twee-delige draaibare flenzen
- draaibare flenzen verkorten de montagetijd
- vanaf de maat DN700 met vaste flenzen



| DN         | Geboord/drukklasse<br>PN | Artikelnr. |
|------------|--------------------------|------------|
| 50 x 40    | 10/16                    | 10030030   |
| 65 x 40    | 10/16                    | 10030033   |
| 65 x 50    | 10/16                    | 10030032   |
| 80 x 40    | 10/16                    | 10030041   |
| 80 x 50    | 10/16                    | 10030040   |
| 80 x 65    | 10/16                    | 10030044   |
| 100 x 40   | 10/16                    | 10030051   |
| 100 x 50   | 10/16                    | 10030050   |
| 100 x 65   | 10/16                    | 10030054   |
| 100 x 80   | 10/16                    | 10030056   |
| 125 x 40   | 10/16                    | 10030058   |
| 125 x 50   | 10/16                    | 10030059   |
| 125 x 65   | 10/16                    | 10030063   |
| 125 x 80   | 10/16                    | 10030065   |
| 125 x 100  | 10/16                    | 10030067   |
| 150 x 40   | 10/16                    | 10030068   |
| 150 x 50   | 10/16                    | 10030069   |
| 150 x 65   | 10/16                    | 10030072   |
| 150 x 80   | 10/16                    | 10030074   |
| 150 x 100  | 10/16                    | 10030076   |
| 150 x 125  | 10/16                    | 10030078   |
| 200 x 80   | 10/16                    | 10030086   |
| 200 x 100  | 10/16                    | 10030088   |
| 200 x 125  | 10/16                    | 10030090   |
| 200 x 150  | 10/16                    | 10030092   |
| 250 x 100  | 10                       | 10030093   |
| 250 x 125  | 10                       | 10030094   |
| 250 x 150  | 10                       | 10030096   |
| 250 x 200  | 10                       | 10030098   |
| 300 x 150  | 10                       | 10030113   |
| 300 x 200  | 10                       | 10030114   |
| 300 x 250  | 10                       | 10030120   |
| 350 x 200  | 10                       | 10030129   |
| 350 x 250  | 10                       | 10030131   |
| 350 x 300  | 10                       | 10030127   |
| 400 x 250  | 10                       | 10030122   |
| 400 x 300  | 10                       | 10030124   |
| 400 x 350  | 10                       | 10030137   |
| 450 x 300  | 10                       | 10030139   |
| 450 x 400  | 10                       | 10030143   |
| 500 x 300  | 10                       | 10030150   |
| 500 x 350  | 10                       | 10030148   |
| 500 x 400  | 10                       | 10030184   |
| 600 x 400  | 10                       | 10030186   |
| 600 x 500  | 10                       | 10030188   |
| 700 x 300  | 10                       | 10103298   |
| 700 x 500  | 10                       | 10103302   |
| 700 x 600  | 10                       | 10103303   |
| 800 x 500  | 10                       | 10103332   |
| 800 x 600  | 10                       | 10103333   |
| 800 x 700  | 10                       | 10103334   |
| 900 x 700  | 10                       | 10103364   |
| 900 x 800  | 10                       | 10103365   |
| 1000 x 800 | 10                       | 10103395   |
| 1000 x 900 | 10                       | 10103396   |

Artikelgroep: 16.01.10

## Gietijzeren fittingen

|  | DN  | Geboord/drukklasse<br>PN | Artikelnr. |                        |
|--|-----|--------------------------|------------|------------------------|
| <b>Fig. 330</b><br><b>GY Voetbocht voor water</b><br>- epoxy gecoat<br>- met twee-delige draaibare flenzen<br>- draaibare flenzen verkorten de montagetijd | 40  | 10/16                    | 10001015   |                        |
|  | 50  | 10/16                    | 10001025   |                        |
|  | 65  | 10/16                    | 10001045   |                        |
|  | 80  | 10/16                    | 10001055   |                        |
|  | 100 | 10/16                    | 10001065   |                        |
|  | 125 | 10/16                    | 10001076   |                        |
|  | 150 | 10/16                    | 10001079   |                        |
|  | 200 | 10                       | 10001087   |                        |
|  | 250 | 10                       | 10001092   |                        |
|  | 300 | 10                       | 10001097   |                        |
|  | 350 | 10                       | 10001105   |                        |
|  | 400 | 10                       | 10001125   |                        |
|  | 500 | 10                       | 10001135   |                        |
|  | 600 | 10                       | 10001145   |                        |
|  |     |                          |            | Artikelgroep: 16.01.10 |



|  | DN  | Geboord/drukklasse<br>PN | Artikelnr.             |
|--|-----|--------------------------|------------------------|
| <b>Fig. 340</b><br><b>GY Blindflens voor water</b><br>- epoxy gecoat | 40  | 10/16                    | 10122001               |
|  | 50  | 10/16                    | 10122031               |
|  | 65  | 10/16                    | 10122014               |
|  | 80  | 10/16                    | 10122018               |
|  | 100 | 10/16                    | 10122013               |
|  | 125 | 10/16                    | 10122314               |
|  | 150 | 10/16                    | 10122012               |
|  | 200 | 10                       | 10122023               |
|  | 250 | 10                       | 10124159               |
|  | 300 | 10                       | 10124171               |
|  | 350 | 10                       | 10122082               |
|  | 400 | 10                       | 10122101               |
|  | 450 | 10                       | 10122103               |
|  | 500 | 10                       | 10122108               |
|  | 600 | 10                       | 10122109               |
|  | 700 | 10                       | 10122112               |
| 800  | 10  | 10122114                 |                        |
| 900  | 10  | 10122116                 |                        |
| 1000   | 10  | 10122118                 |                        |
|  |     |                          | Artikelgroep: 16.01.10 |



|   | DN  | Afmeting gat | Geboord/drukklasse<br>PN | Artikelnr. |
|---|-----|--------------|--------------------------|------------|
| <b>Fig. 345</b><br><b>GY Draadflens voor water</b><br>- epoxy gecoat<br>- met binnendraad | 40  | 1/2"         | 10/16                    | 10133004   |
|   | 50  | 1/2"         | 10/16                    | 10133012   |
|   | 65  | 1/2"         | 10/16                    | 10133027   |
|   | 65  | 2"           | 10/16                    | 10133030   |
|   | 80  | 2"           | 10/16                    | 10133032   |
|   | 100 | 2"           | 10/16                    | 10133043   |
|   | 125 | 2"           | 10/16                    | 10133054   |
|   | 150 | 2"           | 10/16                    | 10133063   |
|   | 200 | 2"           | 10                       | 10133071   |
|   | 250 | 2"           | 10                       | 10133082   |
|   | 300 | 2"           | 10                       | 10133097   |
|   | 350 | 2"           | 10                       | 10133099   |
|   | 400 | 2"           | 10                       | 10133112   |
|   | 450 | 2"           | 10                       | 10133121   |
|   | 500 | 2"           | 10                       | 10133132   |
|   | 600 | 2"           | 10                       | 10133141   |
|   | 700 | 2"           | 10                       | 10133151   |
|   | 800 | 2"           | 10                       | 10133161   |
| 900   | 2"  | 10           | 10133171                 |            |
| 1000  | 2"  | 10           | 10133181                 |            |
|   |     |              | Artikelgroep: 16.01.10   |            |





# 16.01 Fucoli programma

## Gietijzeren fittingen

**Fig. 346**  
GY ½ Flens voor water



| DN  | Geboord/drukklasse<br>PN | Artikelnr. |
|-----|--------------------------|------------|
| 40  | 16                       | 10010010   |
| 50  | 16                       | 10010021   |
| 65  | 16                       | 10010041   |
| 80  | 16                       | 10010051   |
| 100 | 16                       | 10010060   |
| 125 | 16                       | 10010070   |
| 150 | 16                       | 10010080   |
| 200 | 16                       | 10010090   |
| 250 | 16                       | 10010115   |
| 300 | 16                       | 10010121   |
| 350 | 16                       | 10010126   |
| 400 | 16                       | 10010131   |

Artikelgroep: 16.01.10


**Fig. 347**  
GY ½ Flens voor water  
- ANSI B16.5




| DN  | Artikelnr. |
|-----|------------|
| 40  | 10010500   |
| 50  | 10010505   |
| 65  | 10010515   |
| 80  | 10010520   |
| 100 | 10010525   |
| 125 | 10010530   |
| 150 | 10010535   |
| 200 | 10010550   |
| 250 | 10010555   |
| 300 | 10010560   |
| 350 | 10010565   |
| 400 | 10010570   |

Artikelgroep: 16.01.10

## Brandkranen

|   | DN | Artikelnr.  |
|---|----|---|
| <p><b>Fig. 402</b><br/> <b>Ondergrondse brandkraan</b><br/>                     - voorzien van afsluitstop/klauwstop<br/>                     - met CE keur<br/>                     - PN16<br/>                     - aansluiting bajonet = 75mm</p>  | 80 | 11209450<br><small>Artikelgroep: 16.01.10</small> |

|  | DN  | Artikelnr.  |
|--|-----|---|
| <p><b>Fig. 405*</b><br/> <b>Bovengrondse brandkraan</b><br/>                     - met CE keur<br/>                     - PN16<br/>                     - hoogte = 1480mm<br/>                     - inclusief voetbocht</p>  | 100 | 11210040<br><small>Artikelgroep: 16.01.10</small> |

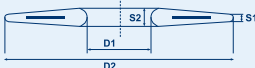
\* Fig. 405.1: Sleutel voor brandkraan, artikelnr. 11209061.

Voor momentsleutels verwijzen wij u naar Groep 21 'Machines en gereedschappen', blz. 292.

# 16.02 PSI Programma

## PSI Pakkingen, afdichtingen en Petro-band

**Fig. 192**  
EPDM Pakking  
met staalinlage  
- voor water



| Afmeting | Drukklasse | D1xD2 / S1xS2<br>in mm | Geschikt voor                     | Artikelnr. |
|----------|------------|------------------------|-----------------------------------|------------|
| DN15     | PN10/40    | 22 x 51 / 3-4          | 20mm PE/PVC/staal                 | 100802462  |
| DN20     | PN10/40    | 27 x 61 / 3-4          | 25mm PE/PVC/staal                 | 100803463  |
| DN25     | PN10/40    | 34 x 71 / 3-4          | 32mm PE/PVC/staal                 | 100801464  |
| DN32     | PN10/40    | 43 x 82 / 3-4          | 40mm PE/PVC/staal                 | 100803418  |
| DN40     | PN10/40    | 49 x 92 / 3-4          | 50mm PE/PVC/staal                 | 100803439  |
| DN50     | PN10/40    | 61 x 107 / 4-5         | 63mm PE/PVC/staal                 | 100803462  |
| DN65     | PN10/40    | 77 x 127 / 4-5         | 75mm PE/PVC/staal                 | 100803483  |
| DN80     | PN10/40    | 89 x 142 / 3-4         | 90mm PE/PVC/staal                 | 100801465  |
| DN100    | PN10/16    | 115 x 162 / 4-5        | 110mm PE/PVC/staal                | 100801466  |
| DN100    | PN25/40    | 115 x 168 / 5-6        | 125mm PE/staal                    | 100801488  |
| DN125    | PN10/16    | 141 x 192 / 4-5        | 140mm PE/PVC/staal                | 100803491  |
| DN150    | PN10/16    | 169 x 218 / 4-5        | 160mm PE/PVC/staal-180mm PE/Staal | 100803495  |
| DN200    | PN10/16    | 220 x 273 / 5-6        | 200mm / 225mm PE/PVC/staal        | 100803499  |
| DN250    | PN10       | 273 x 328 / 5-6        | 250mm / 280mm PE/PVC/staal        | 100803504  |
| DN250    | PN16       | 273 x 329 / 6-7        | 250mm / 280mm PE/PVC/staal        | 100803505  |
| DN300    | PN10       | 324 x 378 / 5-6        | 315mm PE/PVC/staal                | 100803510  |
| DN300    | PN16       | 324 x 384 / 6-7        | 315mm PE/staal                    | 100803511  |
| DN350    | PN10       | 356 x 438 / 6-7        | 355mm PVC                         | 100803515  |
| DN350    | PN16       | 368 x 445 / 7-9        | 355mm PE/staal                    | 100801516  |
| DN400    | PN10       | 407 x 489 / 6-7        | 400mm PE/PVC/staal                | 100903520  |
| DN400    | PN16       | 407 x 495 / 7-9        | 400mm PE/staal                    | 100903521  |
| DN450    | PN10       | 470 x 540 / 7-9        | 450mm PE/staal                    | 100903525  |
| DN450    | PN16       | 470 x 557 / 7-9        | 450mm PE/staal                    | 100901526  |
| DN500    | PN10       | 508 x 594 / 6-7        | 450mm / 500mm PE/staal            | 100901474  |
| DN500    | PN16       | 508 x 617 / 7-9        | 450mm / 500mm PE/staal            | 100903532  |
| DN600    | PN10       | 610 x 695 / 6-7        | 630mm PE/staal                    | 100901475  |
| DN700    | PN10       | 712 x 810 / 7-8        | 710mm PE/staal                    | 100901476  |
| DN800    | PN10       | 813 x 917 / 7-8        | 800mm PE/staal                    | 100901477  |
| DN900    | PN10       | 915 x 1017/7-8         | 900mm PE                          | 100901548  |
| DN1000   | PN10       | 1016 x 1124/7-8        | 1000mm PE                         | 100901479  |

Artikelgroep: 16.02.05

PN6 flenzen zijn op aanvraag leverbaar.

**Fig. 195**  
EPDM Pakking  
- verstelbaar tot 8°

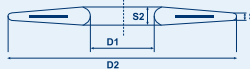


| DN  | Drukklasse | Dikte in mm<br>(min x max) | Maat bout x<br>lengte in mm | Artikelnr. |
|-----|------------|----------------------------|-----------------------------|------------|
| 32  | PN10/40    | 9 x 20                     | M14 x 90                    | 100804001  |
| 40  | PN10/40    | 9 x 22                     | M14 x 90                    | 100804002  |
| 50  | PN10/40    | 9 x 24                     | M14 x 100                   | 100804003  |
| 65  | PN10/40    | 9 x 26                     | M14 x 100                   | 100804004  |
| 80  | PN10/40    | 14 x 30                    | M14 x 100                   | 100804005  |
| 100 | PN10/16    | 14 x 30                    | M14 x 100                   | 100804006  |
| 100 | PN25/40    | 14 x 33                    | M18 x 110                   | 100804007  |
| 125 | PN10/16    | 14 x 36                    | M14 x 100                   | 100804110  |
| 150 | PN10/16    | 14 x 39                    | M18 x 110                   | 100804008  |
| 150 | PN25/40    | 14 x 39                    | M22 x 130                   | 100804009  |
| 200 | PN10/16    | 15 x 50                    | M18 x 120                   | 100804010  |
| 200 | PN40       | 15 x 50                    | M24 x 160                   | 100804011  |
| 250 | PN10/16    | 16 x 59                    | M18 x 140                   | 100804012  |
| 250 | PN40       | 16 x 59                    | M27 x 170                   | 100804013  |
| 300 | PN10       | 22 x 68                    | M18 x 150                   | 100804014  |
| 350 | PN10       | 22 x 68                    | M18 x 150                   | 100804015  |
| 400 | PN10       | 22 x 74                    | M22 x 160                   | 100804016  |
| 500 | PN10       | 23 x 79                    | M22 x 180                   | 100804017  |

Artikelgroep: 16.02.05

## PSI Pakkingen, afdichtingen en Petro-band

**Fig. 205**  
NBR Pakking  
met staalinlage  
- voor water



| Afmeting | Drukklasse | D1xD2 / S1xS2<br>in mm | Geschikt voor                     | Artikelnr. |
|----------|------------|------------------------|-----------------------------------|------------|
| DN15     | PN10/40    | 22 x 51 / 3-4          | 20mm PE/PVC/staal                 | 100801287  |
| DN20     | PN10/40    | 27 x 61 / 3-4          | 25mm PE/PVC/staal                 | 100801288  |
| DN25     | PN10/40    | 34 x 71 / 3-4          | 32mm PE/PVC/staal                 | 100801289  |
| DN32     | PN10/40    | 43 x 82 / 3-4          | 40mm PE/PVC/staal                 | 100903242  |
| DN40     | PN10/40    | 49 x 92 / 3-4          | 50mm PE/PVC/staal                 | 100803263  |
| DN50     | PN10/40    | 61 x 107 / 4-5         | 63mm PE/PVC/staal                 | 100803286  |
| DN65     | PN10/40    | 77 x 127 / 4-5         | 75mm PE/PVC/staal                 | 100803308  |
| DN80     | PN10/40    | 89 x 142 / 3-4         | 90mm PE/PVC/staal                 | 100803309  |
| DN100    | PN10/16    | 115 x 162 / 4-5        | 110mm PE/PVC/staal                | 100803312  |
| DN100    | PN25/40    | 115 x 168 / 5-6        | 125mm PE                          | 100803313  |
| DN125    | PN10/16    | 141 x 192 / 4-5        | 140mm PE/PVC/staal                | 100803316  |
| DN150    | PN10/16    | 169 x 218 / 4-5        | 160mm PE/PVC/staal-180mm PE/staal | 100803320  |
| DN200    | PN10/16    | 220 x 273 / 5-6        | 200mm / 225mm PE/PVC/staal        | 100803324  |
| DN250    | PN10       | 273 x 328 / 5-6        | 250mm / 280mm PE/PVC/staal        | 100803329  |
| DN250    | PN16       | 273 x 329 / 6-7        | 250mm / 280mm PE/PVC/staal        | 100803330  |
| DN300    | PN10       | 324 x 378 / 5-6        | 315mm PE/PVC/staal                | 100803335  |
| DN300    | PN16       | 324 x 384 / 6-7        | 315mm PE/staal                    | 100803336  |
| DN350    | PN10       | 356 x 438 / 6-7        | 355mm PVC                         | 100801297  |
| DN350    | PN16       | 368 x 445 / 7-9        | 355mm PE                          | 100801341  |
| DN400    | PN10       | 407 x 489 / 6-7        | 400mm PE/PVC/staal                | 100903345  |
| DN400    | PN16       | 407 x 495 / 7-9        | 400mm PE/staal                    | 100903346  |
| DN450    | PN10       | 470 x 540 / 7-9        | 450mm PE                          | 100903350  |
| DN450    | PN16       | 470 x 557 / 7-9        | 450mm PE                          | 100901351  |
| DN500    | PN10       | 508 x 594 / 6-7        | 450mm / 500mm PE/staal            | 100903356  |
| DN500    | PN16       | 508 x 617 / 7-9        | 450mm / 500mm PE/staal            | 100903358  |
| DN600    | PN10       | 610 x 695 / 6-7        | 630mm PE/staal                    | 100903362  |
| DN700    | PN10       | 712 x 810 / 7-8        | 710mm PE/staal                    | 100903366  |
| DN800    | PN10       | 813 x 917 / 7-8        | 800mm PE                          | 100901302  |
| DN900    | PN10       | 915 x 1017 / 7-8       | 900mm PE                          | 100901374  |
| DN1000   | PN10       | 1016 x 1124 / 7-8      | 1000mm PE                         | 100901304  |

Artikelgroep: 16.02.05

| Type         | Bereik in mm | Artikelnr. EPDM | Artikelnr. NBR |
|--------------|--------------|-----------------|----------------|
| LS-200-S-316 | 12,7 - 15,7  | 202500139       | 202500156      |
| LS-265-S-316 | 16 - 20      | 202500186       | -              |
| LS-275-S-316 | 16 - 20      | 202500140       | 202500150      |
| LS-300-S-316 | 18 - 22,5    | 202500141       | 202500151      |
| LS-310-S-316 | 18 - 22,5    | 202500187       | -              |
| LS-315-S-316 | 21,1 - 26    | 202500146       | 202500157      |
| LS-325-S-316 | 23,2 - 30    | 202500142       | 202500152      |
| LS-340-S-316 | 25,5 - 34    | 202500143       | 202500055      |
| LS-360-S-316 | 32 - 42      | 202500144       | 202500056      |
| LS-400-S-316 | 36,3 - 46    | 202500172       | 202500153      |
| LS-410-S-316 | 37 - 48,5    | 202500173       | 202500161      |
| LS-425-S-316 | 28,4 - 37    | 202500174       | 202500154      |
| LS-440-S-316 | 44 - 55      | 202500176       | 202500258      |
| LS-475-S-316 | 41,3 - 48,5  | 202500145       | 202500155      |
| LS-500-S-316 | 60,3 - 71,5  | 202500147       | 202500158      |
| LS-525-S-316 | 55,4 - 63,5  | 202500148       | 202500159      |
| LS-575-S-316 | 48 - 58      | 202500149       | 202500160      |
| LS-615-S-316 | 81,6 - 98    | 202500185       | 202500265      |
| LS-650-S-316 | 69 - 84      | 202500177       | 202500259      |



Artikelgroep: 16.02.05

\* EPDM rubber (blauw) op aanvraag leverbaar.

# 16.02 PSI Programma

## PSI Pakkingen, afdichtingen en Petro-band

|                            | Afmeting in mm | Artikelnr. |
|----------------------------|----------------|------------|
| <b>Fig. 210</b>            | 32             | 101100004  |
| <b>Rubber instortflens</b> | 40             | 101100005  |
| <b>(muurdoorvoer)</b>      | 50             | 101100006  |
|                            | 63             | 101100007  |
|                            | 75             | 101100008  |
|                            | 90             | 101100009  |
|                            | 110            | 101100010  |
|                            | 125            | 101100011  |
|                            | 140            | 101100012  |
|                            | 160            | 101100013  |
|                            | 180            | 101100014  |
|                            | 200            | 101100015  |
|                            | 225            | 101100016  |
|                            | 250            | 101100017  |
|                            | 280            | 101100018  |
|                            | 315            | 101100019  |
|                            | 400            | 101100020  |
|                            | 450            | 101100021  |
|                            | 500            | 101100022  |
|                            | 560            | 101100023  |
|                            | 630            | 101100024  |
|                            | 800            | 101100029  |

Artikelgroep: 16.02.05

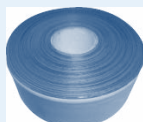


|                       | Type                | Artikelnr. |
|-----------------------|---------------------|------------|
| <b>Fig. 230</b>       | Type AZ/AC 1- 16    | 300200085  |
| <b>Afstandhouder</b>  | Type AZ/AC 1- 25    | 300200086  |
| - voor het leggen van | Type AZ/AC 1- 36    | 300200087  |
| leidingen in buis     | Type AZ/AC 1- 55    | 300200088  |
| - maatbereik          | Type AZ/AC 1- 75    | 300200089  |
| leidingdiameter:      | Type AZ/AC 1- 90    | 300200083  |
| 98 t/m 385mm          | Type AZ/AC 1-110    | 300200097  |
| - modulair systeem    | Type AZ/AC 2- 16    | 300200090  |
|                       | Type AZ/AC 2- 25    | 300200091  |
|                       | Type AZ/AC 2- 36    | 300200092  |
|                       | Type AZ/AC 2- 55    | 300200093  |
|                       | Type AZ/AC 2- 75    | 300200094  |
|                       | Type AZ/AC 2- 90    | 300200095  |
|                       | Type AZ/AC 2-110    | 300200096  |
|                       | Type MA 1- 25       | 300200050  |
|                       | Type MA 1- 36       | 300200051  |
|                       | Type MA 1- 50       | 300200053  |
|                       | Type MA 1- 65       | 300200064  |
|                       | Type MA 1- 75       | 300200054  |
|                       | Type MA 2- 25       | 300200055  |
|                       | Type MA 2- 36       | 300200056  |
|                       | Type MA 2- 50       | 300200057  |
|                       | Type MA 2- 65       | 300200063  |
|                       | Type MA 2- 75       | 300200058  |
|                       | Type PA/PE 2- 36*   | 300101018  |
|                       | Type PA/PE 2,5- 36* | 300101022  |
|                       | Type PA/PE 4- 16*   | 300101028  |
|                       | Type PA/PE 9- 55*   | 300101123  |

Artikelgroep: 16.02.05



|  | Breedte in mm | Lengte in meter | Artikelnr.             |
|--|---------------|-----------------|------------------------|
| <b>Fig. 231</b>                                      | 50            | 15              | 4002S20088             |
| <b>Band voor afstandhouders</b>                      |               |                 | Artikelgroep: 16.02.05 |
| - anti-slip band voor het gebruik met afstandhouders |               |                 |                        |



|                        | Breedte in mm | Artikelnr.             |
|------------------------|---------------|------------------------|
| <b>Fig. 240</b>        | 50            | 403500003              |
| <b>Kebu Petro-band</b> | 100           | 403500004              |
| - rol à 10 meter       |               | Artikelgroep: 16.02.05 |



|                           | Breedte in mm | Artikelnr.             |
|---------------------------|---------------|------------------------|
| <b>Fig. 243</b>           | 50            | 403500026              |
| <b>Kebu Reparatieband</b> |               | Artikelgroep: 16.02.05 |
| - rol à 10 meter          |               |                        |



|                        | Inhoud in gram | Artikelnr.             |
|------------------------|----------------|------------------------|
| <b>Fig. 246</b>        | 500            | 403500046              |
| <b>Kebu Kneedmassa</b> |                | Artikelgroep: 16.02.05 |



|                                       | Inhoud in ml | Artikelnr.             |
|---------------------------------------|--------------|------------------------|
| <b>Fig. 247</b>                       | 310          | 401522820              |
| <b>Stopaq afdichtingspasta FN2100</b> |              | Artikelgroep: 16.02.05 |



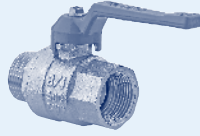
Neem voor de geschikte afstandhouder voor uw toepassing en het benodigde aantal contact op met onze afdeling verkoop.  
\* 1 ring = 2 stuks

## Messing verchroomde kogelkranen

|  | Afmeting | Artikelnr. |
|--|----------|------------|
| <b>840</b><br><b>Messing verchroomde kogelkraan</b><br>- volle doorlaat<br>- aluminium handle<br>- 2 x binnendraad | 1/2"     | 840012     |
|  | 3/4"     | 840034     |
|  | 1"       | 840100     |
|  | 1 1/4"   | 840114     |
|  | 1 1/2"   | 840112     |
|  | 2"       | 840200     |
|  | 2 1/2"   | 840212     |
|  | 3"       | 840300     |
|  | 4"       | 840400     |
| Artikelgroep: 16.03.05   |          |            |



|  | Afmeting               | Artikelnr. |
|--|------------------------|------------|
| <b>845</b><br><b>Messing verchroomde kogelkraan</b><br>- industriekwaliteit<br>- volle doorlaat<br>- aluminium handle<br>- binnendraad x buitendraad | 1/2"                   | 845012     |
|  | 3/4"                   | 845034     |
|  | 1"                     | 845100     |
|  | 1 1/4"                 | 845114     |
|  | Artikelgroep: 16.03.05 |            |



|   | Afmeting | Artikelnr. |
|---|----------|------------|
| <b>850</b><br><b>Messing verchroomde kogelkraan</b><br>- gereduceerde doorlaat<br>- aluminium handle<br>- 2 x binnendraad | 1/2"     | 850012     |
|   | 3/4"     | 850034     |
|   | 1"       | 850100     |
|   | 1 1/4"   | 850114     |
|   | 1 1/2"   | 850112     |
|   | 2"       | 850200     |
| Artikelgroep: 16.03.05  |          |            |



|  | Afmeting | Artikelnr. |
|--|----------|------------|
| <b>300</b><br><b>Messing verchroomde kogelkraan</b><br>- industriekwaliteit<br>- volle doorlaat<br>- aluminium handle<br>- 2 x binnendraad | 1/4"     | 300014     |
|  | 3/8"     | 300038     |
|  | 1/2"     | 300012     |
|  | 3/4"     | 300034     |
|  | 1"       | 300100     |
|  | 1 1/4"   | 300114     |
|  | 1 1/2"   | 300112     |
|  | 2"       | 300200     |
| Artikelgroep: 16.03.05   |          |            |



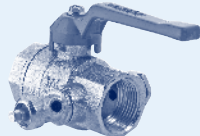
|  | Afmeting | Artikelnr. |
|--|----------|------------|
| <b>842</b><br><b>Messing verchroomde kogelkraan</b><br>- volle doorlaat<br>- plaatstalen handle<br>- 2 x binnendraad | 1/4"     | 842014     |
|  | 1/2"     | 842012     |
|  | 3/4"     | 842034     |
|  | 1"       | 842100     |
|  | 1 1/4"   | 842114     |
|  | 1 1/2"   | 842112     |
|  | 2"       | 842200     |
| Artikelgroep: 16.03.05   |          |            |




|  | Afmeting | Artikelnr. |
|--|----------|------------|
| <b>610</b><br><b>Messing verchroomde kogelkraan</b><br>- volle doorlaat<br>- gele stalen handle<br>- 2 x binnendraad<br>- DIN en DVGW keur waar van toepassing | 1/4"     | 610014     |
|  | 3/8"     | 610038     |
|  | 1/2"     | 610012     |
|  | 3/4"     | 610034     |
|  | 1"       | 610100     |
|  | 1 1/4"   | 610114     |
|  | 1 1/2"   | 610112     |
|  | 2"       | 610200     |
| Artikelgroep: 16.03.05   |          |            |



|   | Afmeting | Artikelnr. |
|---|----------|------------|
| <b>841</b><br><b>Messing verchroomde kogelkraan met aftapper</b><br>- volle doorlaat<br>- aluminium handle<br>- 2 x binnendraad<br>- aftapgelegenheid | 1/2"     | 841012     |
|   | 3/4"     | 841034     |
|   | 1"       | 841100     |
| Artikelgroep: 16.03.05  |          |            |



|  | Afmeting | Artikelnr. |
|--|----------|------------|
| <b>450</b><br><b>Messing verchroomde kogelkraan met slangwartel</b><br>- aluminium handle<br>- buitendraad x slangwartel | 3/8"     | 450038     |
|  | 1/2"     | 450012     |
|  | 3/4"     | 450034     |
|  | 1"       | 450100     |
| Artikelgroep: 16.03.05   |          |            |




# 16.03 Metalen appendages

## Messing verchromde kogelkranen

|   | Afmeting | Artikelnr.             |
|---|----------|------------------------|
| <b>855</b><br>Messing verchromde kogelkraan<br>- gereduceerde doorlaat<br>- aluminium handle<br>- binnendraad x buitendraad | 1/2"     | 855012                 |
|   | 3/4"     | 855034                 |
|   | 1"       | 855100                 |
|   | 1 1/4"   | 855114                 |
|   |          | Artikelgroep: 16.03.05 |



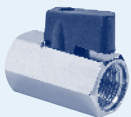
|   | Afmeting | Artikelnr. L-boring volle doorlaat | Artikelnr. T-boring volle doorlaat |
|---|----------|------------------------------------|------------------------------------|
| <b>535</b><br>Messing verchromde 3-weg kogelkraan<br>- aluminium handle | 1/4"     | 535014                             | 5350141                            |
|   | 3/8"     | 535038                             | 5350381                            |
|   | 1/2"     | 535012                             | 5350121                            |
|   | 3/4"     | 535034                             | 5350341                            |
|   | 1"       | 535100                             | 5351001                            |
|   | 1 1/4"   | 535114                             | 5351141                            |
|   | 1 1/2"   | 535112                             | 5351121                            |
|   | 2"       | 535200                             | 5352001                            |
|   |          |                                    |                                    |
|   |          |                                    |                                    |



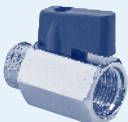
|  | Afmeting | Artikelnr. L-boring gereduceerd | Artikelnr. T-boring gereduceerd |
|--|----------|---------------------------------|---------------------------------|
|  | 3/8"     | 5350382                         | 5350383                         |
|  | 1/2"     | 5350122                         | 5350123                         |
|  | 3/4"     | 5350342                         | 5350343                         |
|  | 1"       | 5351002                         | 5351003                         |
|  | 1 1/4"   | 5351142                         | 5351143                         |
|  | 1 1/2"   | 5351122                         | 5351123                         |
|  | 2"       | 5352002                         | 5352003                         |
|  |          |                                 |                                 |
|  |          |                                 |                                 |

Artikelgroep: 16.03.05

|   | Afmeting | Artikelnr.             |
|---|----------|------------------------|
| <b>400</b><br>Messing verchromde mini kogelkraan<br>- normale uitvoering<br>- 2 x binnendraad | 1/4"     | 400014                 |
|   | 3/8"     | 400038                 |
|   | 1/2"     | 400012                 |
|   |          | Artikelgroep: 16.03.05 |



|   | Afmeting | Artikelnr.             |
|---|----------|------------------------|
| <b>405</b><br>Messing verchromde mini kogelkraan<br>- normale uitvoering<br>- binnendraad x buitendraad | 1/4"     | 405014                 |
|   | 3/8"     | 405038                 |
|   | 1/2"     | 405012                 |
|   |          | Artikelgroep: 16.03.05 |



## Messing/bronzen schuifafsluiters

|   | Afmeting | Artikelnr.             |
|---|----------|------------------------|
| <b>1570</b><br>Messing schuifafsluiter<br>- standaard uitvoering<br>- 2 x binnendraad | 1/4"     | 1570014                |
|   | 3/8"     | 1570038                |
|   | 1/2"     | 1570012                |
|   | 3/4"     | 1570034                |
|   | 1"       | 1570100                |
|   | 1 1/4"   | 1570114                |
|   | 1 1/2"   | 1570112                |
|   | 2"       | 1570200                |
|   | 2 1/2"   | 1570212                |
|   | 3"       | 1570300                |
|   | 4"       | 1570400                |
|   | 5"       | 1570500                |
|   | 6"       | 1570600                |
|   |          | Artikelgroep: 16.03.10 |



|   | Afmeting | Artikelnr. |
|---|----------|------------|
| <b>1600</b><br>Brons/messing schuifafsluiter<br>- industriële uitvoering<br>- 2 x binnendraad | 1/4"     | 1600014    |
|   | 3/8"     | 1600038    |
|   | 1/2"     | 1600012    |
|   | 3/4"     | 1600034    |
|   | 1"       | 1600100    |
|   | 1 1/4"   | 1600114    |
|   | 1 1/2"   | 1600112    |
|   | 2"       | 1600200    |
|   | 2 1/2"   | 1600212    |
|   | 3"       | 1600300    |
|   | 4"       | 1600400    |
|   | 5"       | 1600500    |
|   |          |            |



|  | Afmeting    | Artikelnr.             |
|--|-------------|------------------------|
| <b>851</b><br>Aluminium handle<br>- kleur: rood<br>- voor diverse messing verchromde kogelkranen | 1/2" - 3/4" | 851012                 |
|  | 1" - 1 1/4" | 851100                 |
|  | 1 1/2" - 2" | 851112                 |
|  | 2 1/2"      | 851212                 |
|  | 3"          | 851300                 |
|  |             | Artikelgroep: 16.03.10 |



|  | Afmeting           | Artikelnr.             |
|--|--------------------|------------------------|
| <b>15701</b><br>Handwiel<br>- voor artikelnr. 1570 en 1600 | 3/8" - 1/2" - 3/4" | 15700381               |
|  | 1"                 | 15701001               |
|  | 1 1/4"             | 15701141               |
|  | 1 1/2"             | 15701121               |
|  | 2"                 | 15702001               |
|  | 2 1/2" - 3"        | 15702121               |
|  | 4"                 | 15704001               |
|  |                    | Artikelgroep: 16.03.10 |



## Messing terugslagkleppen

|  | Afmeting | Artikelnr. |
|--|----------|------------|
| <b>1030</b><br><b>Messing terugslagklep</b><br>- veerbelast<br>- 2 x binnendraad | 1/4"     | 1030014    |
|  | 3/8"     | 1030038    |
|  | 1/2"     | 1030012    |
|  | 3/4"     | 1030034    |
|  | 1"       | 1030100    |
|  | 1 1/4"   | 1030114    |
|  | 1 1/2"   | 1030112    |
|  | 2"       | 1030200    |
|  | 2 1/2"   | 1030212    |
|  | 3"       | 1030300    |
|  | 4"       | 1030400    |

Artikelgroep: 16.03.15



|   | Afmeting | Artikelnr. |
|---|----------|------------|
| <b>2090</b><br><b>Kunststof zuigkorf</b><br>- voor artikelnr. 1420<br>- binnendraad aansluiting | 1/2"     | 2090012    |
|   | 3/4"     | 2090034    |
|   | 1"       | 2090100    |
|   | 1 1/4"   | 2090114    |
|   | 1 1/2"   | 2090112    |
|   | 2"       | 2090200    |
|   |          |            |



|   | Afmeting | Artikelnr. |
|---|----------|------------|
| <b>1081</b><br><b>Messing metalen zuigkorf</b><br>- voor artikelnr. 1030<br>- buitendraad aansluiting | 3/8"     | 1081038    |
|   | 1/2"     | 1081012    |
|   | 3/4"     | 1081034    |
|   | 1"       | 1081100    |
|   | 1 1/4"   | 1081114    |
|   | 1 1/2"   | 1081112    |
|   | 2"       | 1081200    |
|   | 2 1/2"   | 1081212    |
|   | 3"       | 1081300    |
|   | 4"       | 1081400    |

Artikelgroep: 16.03.15



|  | Afmeting | Artikelnr. |
|--|----------|------------|
| <b>1500</b><br><b>Messing terugslagklep</b><br>- 1 x binnendraad<br>- voetklep, pijpmodel<br>- verticale installatie | 1/2"     | 1500012    |
|  | 3/4"     | 1500034    |
|  | 1"       | 1500100    |
|  | 1 1/4"   | 1500114    |
|  | 1 1/2"   | 1500112    |
|  | 2"       | 1500200    |
|  | 2 1/2"   | 1500212    |
|  | 3"       | 1500300    |
|  | 4"       | 1500400    |
|  |          |            |



|   | Afmeting | Artikelnr. |
|---|----------|------------|
| <b>1420</b><br><b>Messing terugslagklep Tuxhorn</b><br>- binnendraad x buitendraad<br>- rubberdichting<br>- verticale installatie | 1/2"     | 1420012    |
|   | 3/4"     | 1420034    |
|   | 1"       | 1420100    |
|   | 1 1/4"   | 1420114    |
|   | 1 1/2"   | 1420112    |
|   | 2"       | 1420200    |

Artikelgroep: 16.03.15



|  | Afmeting | Artikelnr. |
|--|----------|------------|
| <b>1300</b><br><b>Messing terugslagklep</b><br>- niet veerbelast<br>- 2 x binnendraad<br>- horizontale installatie | 3/8"     | 1300038    |
|  | 1/2"     | 1300012    |
|  | 3/4"     | 1300034    |
|  | 1"       | 1300100    |
|  | 1 1/4"   | 1300114    |
|  | 1 1/2"   | 1300112    |
|  | 2"       | 1300200    |
|  | 2 1/2"   | 1300212    |
|  | 3"       | 1300300    |
|  | 4"       | 1300400    |
|  | 5" *     | 1300500    |
|  | 6" *     | 1300600    |

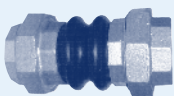
\* Brons/messing.  
Artikelgroep: 16.03.15



## Compensatoren

|   | Afmeting | Artikelnr. |
|---|----------|------------|
| <b>238</b><br><b>Compensator</b><br>- balg EPDM*<br>- 3-delige koppelingen<br>- met binnendraad | 3/4"     | 238034     |
|   | 1"       | 238100     |
|   | 1 1/4"   | 238114     |
|   | 1 1/2"   | 238112     |
|   | 2"       | 238200     |
|   | 2 1/2"   | 238212     |

Artikelgroep: 16.03.20



\* Andere rubbersoorten op aanvraag leverbaar.

|  | Afmeting | Geboord/<br>drukklasse PN | Artikelnr. |
|--|----------|---------------------------|------------|
| <b>239</b><br><b>Compensator</b><br>- balg EPDM*<br>- gegalvaniseerde stalen flenzen<br>- lengte = 130mm | DN32     | 10/16                     | 239032     |
|  | DN40     | 10/16                     | 239040     |
|  | DN50     | 10/16                     | 239050     |
|  | DN65     | 10/16                     | 239065     |
|  | DN80     | 10/16                     | 239080     |
|  | DN100    | 10/16                     | 239100     |
|  | DN125    | 10/16                     | 239125     |
|  | DN150    | 10/16                     | 239150     |
|  | DN200    | 10                        | 239200     |
|  | DN250    | 10                        | 239250     |
|  | DN300    | 10                        | 239300     |
|  | DN200    | 16                        | 2392001    |
|  | DN250    | 16                        | 2392501    |
|  | DN300    | 16                        | 2393001    |

Artikelgroep: 16.03.20



\* Andere rubbersoorten op aanvraag leverbaar.



# 16.03 Metalen appendages

## Overige metalen appendages

|                           | Afmeting | Artikelnr. |
|---------------------------|----------|------------|
| <b>1421</b>               | 3/8"     | 1421038    |
| <b>Messing</b>            | 1/2"     | 1421012    |
| <b>veiligheidstoestel</b> | 3/4"     | 1421034    |
| - 2 x binnendraad         | 1"       | 1421100    |
| - instelbaar 1-12 bar     | 1 1/4"   | 1421114    |
|                           | 1 1/2"   | 1421112    |
|                           | 2"       | 1421200    |
|                           | 2 1/2" * | 1421212    |
|                           | 3" *     | 1421300    |
| Artikelgroep: 16.03.30    |          |            |



\* Brons/messing.

|                        | Afmeting | Artikelnr. |
|------------------------|----------|------------|
| <b>1202</b>            | 1/2"     | 1202012    |
| <b>Arion filter</b>    | 3/4"     | 1202034    |
|                        | 1"       | 1202100    |
|                        | 1 1/4"   | 1202114    |
|                        | 1 1/2"   | 1202112    |
|                        | 2"       | 1202200    |
| Artikelgroep: 16.03.30 |          |            |




|                           | Afmeting | Artikelnr. |
|---------------------------|----------|------------|
| <b>1422</b>               | 1/4"     | 1422014    |
| <b>Messing vuilvanger</b> | 3/8"     | 1422038    |
| - RVS filter              | 1/2"     | 1422012    |
| - 2 x binnendraad         | 3/4"     | 1422034    |
|                           | 1"       | 1422100    |
|                           | 1 1/4"   | 1422114    |
|                           | 1 1/2"   | 1422112    |
|                           | 2"       | 1422200    |
|                           | 2 1/2"   | 1422212    |
|                           | 3" *     | 1422300    |
|                           | 4" *     | 1422400    |
| Artikelgroep: 16.03.30    |          |            |




\* Brons/messing.

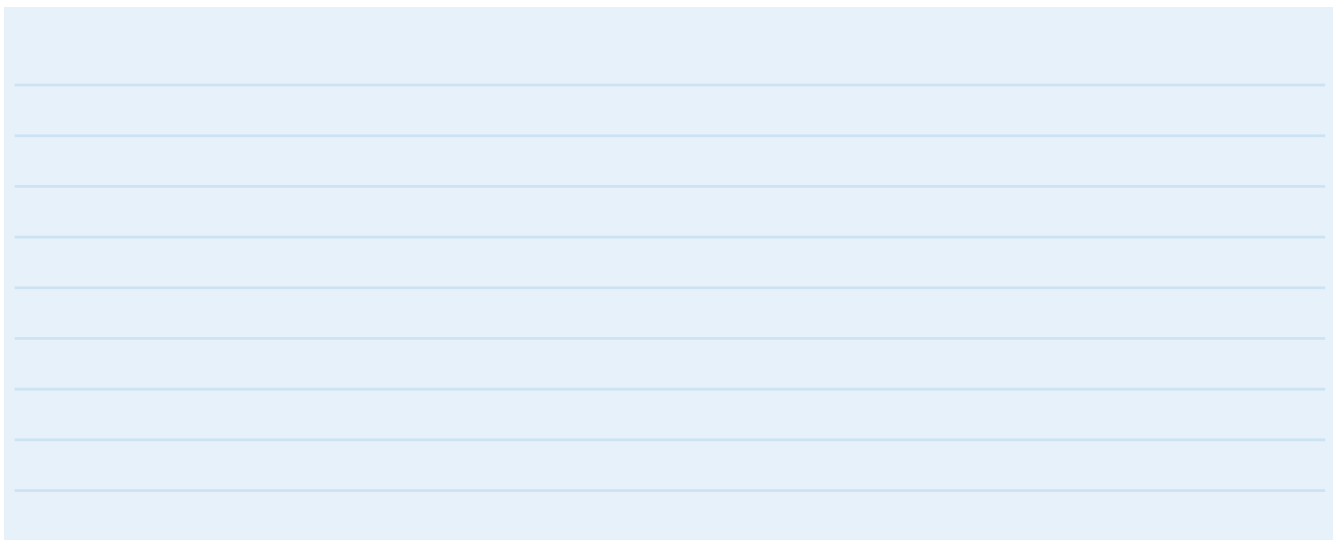
|                            | Afmeting      | Artikelnr. |
|----------------------------|---------------|------------|
| <b>2700</b>                | DN50 (2")     | 2700050    |
| <b>Dubbeldisc keerklep</b> | DN65 (2 1/2") | 2700065    |
| - met RVS disc             | DN80 (3")     | 2700080    |
| - gietijzer huis           | DN100 (4")    | 2700100    |
| - voor inbouw tussen       | DN125 (5")    | 2700125    |
| PN10 flenzen               | DN150 (6")    | 2700150    |
|                            | DN200 (8")    | 2700200    |
|                            | DN250 (10")   | 2700250    |
|                            | DN300 (12")   | 2700300    |
| Artikelgroep: 16.03.30     |               |            |



|                            | Afmeting | Artikelnr. |
|----------------------------|----------|------------|
| <b>1304</b>                | 1/2"     | 1304012    |
| <b>Messing</b>             | 3/4"     | 1304034    |
| <b>drukreduceerventiel</b> | 1"       | 1304100    |
| - 2 x binnendraad          | 1 1/4"   | 1304114    |
| - reduceerbaar tot         | 1 1/2"   | 1304112    |
| maximaal 1 bar             | 2"       | 1304200    |
|                            | 2 1/2" * | 1304212    |
|                            | 3" *     | 1304300    |
|                            | 4" *     | 1304400    |
| Artikelgroep: 16.03.30     |          |            |





\* Brons/messing.



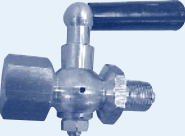
## Mano- en vacuümmeters met kastdiameter 63mm

- Andere uitvoeringen mano-, vacuüm- en watermeters zijn op aanvraag leverbaar.

|  |   | Schaalverdeling in bar    | Artikelnr. |  |
|--|---|---------------------------|------------|--|
| <b>1301</b><br><b>Manometer/Vacuümmeter</b><br>- stalen kast<br>- messing aansluiting<br>- droog<br>- 1/4" onder- of achteraansluiting |  | -1 + 0 onderaansluiting   | 130111     |  |
|  |   | -1 + 3 onderaansluiting   | 130113     |  |
|  |   | 0 + 1,6 onderaansluiting  | 130102     |  |
|  |   | 0 + 4 onderaansluiting    | 130104     |  |
|  |   | 0 + 6 onderaansluiting    | 130106     |  |
|  |   | 0 + 10 onderaansluiting   | 130110     |  |
|  |   | 0 + 16 onderaansluiting   | 130116     |  |
|  |   | -1 + 0 achteraansluiting  | 1301021    |  |
|  |   | 0 + 2,5 achteraansluiting | 1301031    |  |
|  |   | 0 + 4 achteraansluiting   | 1301041    |  |
|  |   | 0 + 6 achteraansluiting   | 1301061    |  |
|  |   | 0 + 10 achteraansluiting  | 1301101    |  |
|  |   | 0 + 16 achteraansluiting  | 1301161    |  |
|  |   | Artikelgroep: 16.04.05    |            |  |

|   |   | Schaalverdeling in bar | Artikelnr. |
|---|---|------------------------|------------|
| <b>1306</b><br><b>Manometer/Vacuümmeter</b><br>- RVS kast<br>- messing aansluiting<br>- glycerine gevuld<br>- 1/4" onderaansluiting |  | -1 + 0                 | 130611     |
|   |   | -1 + 3                 | 130613     |
|   |   | -1 + 9                 | 130619     |
|   |   | 0 + 0,6                | 130600     |
|   |   | 0 + 1                  | 130601     |
|   |   | 0 + 1,6                | 130602     |
|   |   | 0 + 4                  | 130604     |
|   |   | 0 + 6                  | 130606     |
|   |   | 0 + 10                 | 130610     |
|   |   | 0 + 16                 | 130616     |
|   |   | 0 + 25                 | 130625     |
|   |   | Artikelgroep: 16.04.05 |            |

|  |   | Schaalverdeling in bar | Artikelnr. |
|--|---|------------------------|------------|
| <b>1307</b><br><b>Manometer</b><br>- RVS kast<br>- messing aansluiting<br>- glycerine gevuld<br>- 1/4" achteraansluiting |  | -1 + 1,5               | 130712     |
|  |   | 0 + 1,6                | 130702     |
|  |   | 0 + 4                  | 130704     |
|  |   | 0 + 6                  | 130706     |
|  |   | 0 + 10                 | 130710     |
|  |   | 0 + 16                 | 130716     |
|  |   | 0 + 25                 | 130725     |
|  |   | Artikelgroep: 16.04.05 |            |

|  |   | Afmeting    | Artikelnr. |
|--|---|-------------|------------|
| <b>1303</b><br><b>Manometerkraan</b><br>- messing<br>- binnendraad x buitendraad |  | 1/4" x 1/4" | 1303014014 |
|  |   | 1/2" x 1/2" | 1303012012 |
| Artikelgroep: 16.04.05   |   |             |            |

# 16.04 Mano-, vacuüm- en watermeters

## Mano- en vacuümmeters met kastdiameter 100mm

### 1310

#### Manometer – vacuümmeter

- stalen kast
- messing aansluiting
- droog
- 1/2" onderaansluiting



#### Schaalverdeling in bar

#### Artikelnr.

|         |        |
|---------|--------|
| -1 + 0  | 131010 |
| -1 + 3  | 131013 |
| -1 + 5  | 131015 |
| -1 + 9  | 131019 |
| -1 + 15 | 131020 |
| 0 + 0,6 | 131000 |
| 0 + 1   | 131001 |
| 0 + 1,6 | 131002 |
| 0 + 2,5 | 131003 |
| 0 + 4   | 131004 |
| 0 + 6   | 131006 |
| 0 + 10  | 131011 |
| 0 + 16  | 131016 |
| 0 + 25  | 131025 |

Artikelgroep: 16.04.05

### 1311

#### Manometer – vacuümmeter

- RVS kast
- messing aansluiting
- glycerine gevuld
- 1/2" onderaansluiting



#### Schaalverdeling in bar

#### Artikelnr.

|          |        |
|----------|--------|
| -1 + 0   | 131110 |
| -1 + 1,5 | 131112 |
| -1 + 3   | 131113 |
| -1 + 5   | 131115 |
| -1 + 9   | 131119 |
| -1 + 15  | 131120 |
| 0 + 1    | 131101 |
| 0 + 1,6  | 131102 |
| 0 + 2,5  | 131103 |
| 0 + 4    | 131104 |
| 0 + 6    | 131106 |
| 0 + 10   | 131111 |
| 0 + 16   | 131116 |
| 0 + 25   | 131125 |

Artikelgroep: 16.04.05

### 1312

#### Manometer – vacuümmeter

- RVS kast
- RVS binnenwerk
- RVS aansluiting
- glycerine gevuld
- 1/2" onderaansluiting



#### Schaalverdeling in bar

#### Artikelnr.

|          |        |
|----------|--------|
| -1 + 0   | 131210 |
| -1 + 1,5 | 131212 |
| -1 + 3   | 131213 |
| 0 + 2,5  | 131203 |
| 0 + 4    | 131204 |
| 0 + 6    | 131206 |

Artikelgroep: 16.04.05

### 1313

#### Manometer – vacuümmeter

- RVS kast
- RVS binnenwerk
- RVS aansluiting
- glycerine gevuld
- 1/2" achteraansluiting



#### Schaalverdeling in bar

#### Artikelnr.

|          |        |
|----------|--------|
| -1 + 0   | 131310 |
| -1 + 1,5 | 131312 |
| -1 + 3   | 131313 |
| 0 + 2,5  | 131303 |
| 0 + 4    | 131304 |

Artikelgroep: 16.04.05

## Watermeters

|  | Aansluiting* | Doorlaat | Qn   | Q/max m <sup>3</sup> /h | Artikelnr.**           |
|--|--------------|----------|------|-------------------------|------------------------|
| <b>124</b><br><b>Watermeter met KIWA-keur</b><br>- natloper<br>- voor koud water<br>- meerstraal schoepenmeter<br>- voor horizontale montage | 3/4"         | 1/2"     | 1,5  | 3                       | 124034012              |
|  | 1"           | 3/4"     | 2,5  | 5                       | 124100034              |
|  | 1 1/4"       | 1"       | 3,5  | 7                       | 124114100              |
|  | 1 1/2"       | 1 1/4"   | 6,0  | 10                      | 124112114              |
|  | 2"           | 1 1/2"   | 10,0 | 20                      | 124200112              |
|  |              |          |      |                         | Artikelgroep: 16.04.10 |



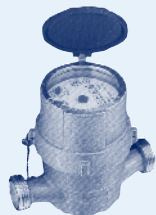
\* Buitendraad.  
 \*\* Exclusief koppelingen.

|  | Aansluiting* | Doorlaat | Qn   | Q/max m <sup>3</sup> /h | Artikelnr.**           |
|--|--------------|----------|------|-------------------------|------------------------|
| <b>122</b><br><b>Watermeter zonder KIWA-keur</b><br>- natloper<br>- voor koud water<br>- enkelstraal schoepenmeter<br>- ook leverbaar in uitvoering tot 90°C | 3/4"         | 1/2"     | 1,5  | 3                       | 122034012              |
|  | 1"           | 3/4"     | 2,5  | 5                       | 122100034              |
|  | 1 1/4"       | 1"       | 3,5  | 7                       | 122114100              |
|  | 1 1/2"       | 1 1/4"   | 5,0  | 10                      | 122112114              |
|  | 2"           | 1 1/2"   | 10,0 | 20                      | 122200112              |
|  |              |          |      |                         | Artikelgroep: 16.04.10 |



\* Buitendraad.  
 \*\* Exclusief koppelingen.

|   | Aansluiting* | Doorlaat | Qn   | Q/max m <sup>3</sup> /h | Artikelnr.**           |
|---|--------------|----------|------|-------------------------|------------------------|
| <b>123</b><br><b>Watermeter zonder KIWA-keur</b><br>- droogloper<br>- voor koud water<br>- voor licht vervuild water<br>- enkelstraal | 3/4"         | 1/2"     | 1,5  | 3                       | 123034012              |
|   | 1"           | 3/4"     | 2,5  | 5                       | 123100034              |
|   | 1 1/4"       | 1"       | 3,5  | 7                       | 123114100              |
|   | 1 1/2"       | 1 1/4"   | 5,0  | 10                      | 123112114              |
|   | 2"           | 1 1/2"   | 10,0 | 20                      | 123200112              |
|   |              |          |      |                         | Artikelgroep: 16.04.10 |



\* Buitendraad.  
 \*\* Exclusief koppelingen.

|   | Aansluiting* | Doorlaat | Qn   | Q/max m <sup>3</sup> /h | Artikelnr.**           |
|---|--------------|----------|------|-------------------------|------------------------|
| <b>127</b><br><b>Watermeter met pulsgever</b><br>- droogloper | 3/4"         | 1/2"     | 1,5  | 3                       | 127034...              |
|   | 1"           | 3/4"     | 2,5  | 5                       | 127100...              |
|   | 1 1/4"       | 1"       | 3,5  | 7                       | 127114...              |
|   | 1 1/2"       | 1 1/4"   | 5,0  | 10                      | 127112...              |
|   | 2"           | 1 1/2"   | 10,0 | 20                      | 127200...              |
|   | 2 1/2"       | 2"       | 15,0 | 30                      | 127212...              |
|   |              |          |      |                         | Artikelgroep: 16.04.10 |

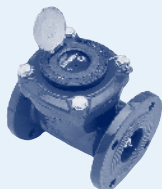


\* Exclusief koppelingen.  
 \*\* Voor het bestellen van de gewenste pulsen het volgende aan artikelnr. toevoegen:  
 ... = 001 (1 puls = 1 liter)  
 ... = 010 (1 puls = 10 liter)  
 ... = 100 (1 puls = 100 liter)  
 Artikelnr. 127999999: pulskabel 2 meter.

# 16.04 Mano-, vacuüm- en watermeters

## Watermeters

|   | Aansluiting | Qn  | Q/max m <sup>3</sup> /h | Artikelnr.             |
|---|-------------|-----|-------------------------|------------------------|
| <b>129</b><br><b>Watermeter type Woltmann</b><br>- met flensaansluiting<br>- met ijkcertificaat 2004/22/EC MID MI001<br>- voor water tot 50°C<br>- voor water tot 130°C, prijs en levertijd op aanvraag | DN50 (2")   | 15  | 30                      | 129050                 |
|   | DN65 (2½")  | 25  | 50                      | 129065                 |
|   | DN80 (3")   | 40  | 80                      | 129080                 |
|   | DN100 (4")  | 60  | 120                     | 129100                 |
|   | DN150 (6")  | 150 | 300                     | 129150                 |
|   |             |     |                         | Artikelgroep: 16.04.10 |

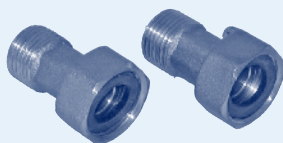


|  | Aansluiting | Puls per eenheid | Artikelnr.             |
|--|-------------|------------------|------------------------|
| <b>235</b><br><b>Watermeter type Woltmann met puls</b><br>- met flensaansluiting<br>- met ijkcertificaat 2004/22/EC MID MI001<br>- voor water tot 50°C | DN50        | 1 per 100 liter  | 235050100              |
|  | DN65        | 1 per 100 liter  | 235065100              |
|  | DN80        | 1 per 100 liter  | 235080100              |
|  | DN100       | 1 per 100 liter  | 235100100              |
|  | DN100       | 1 per 10 liter   | 235100010              |
|  | DN125       | 1 per 100 liter  | 235125100              |
|  |             |                  | Artikelgroep: 16.04.10 |



## Toebehoren voor watermeters

|  | Afmeting  | Artikelnr.             |
|--|-----------|------------------------|
| <b>128</b><br><b>Messing 2-delige koppeling</b><br>- binnendraad x buitendraad | ¾" x ½"   | 128034012              |
|  | 1" x ¾"   | 128100034              |
|  | 1¼" x 1"  | 128114100              |
|  | 1½" x 1¼" | 128112114              |
|  | 2" x 1½"  | 128200112              |
|  | 2½" x 2"  | 128212200              |
|  |           | Artikelgroep: 16.04.10 |



|                                       | Afmeting                           | Artikelnr.             |
|---------------------------------------|------------------------------------|------------------------|
| <b>125</b><br><b>Watermeterbeugel</b> | ¾" x ½" voor artikelnr. 122 en 123 | 125034012              |
|                                       | ¾" x ½" voor artikelnr. 124 Qn 1,5 | 125034012K             |
|                                       | 1" x ¾" voor artikelnr. 124 Qn 2,5 | 125100034              |
|                                       |                                    | Artikelgroep: 16.04.10 |



# Productgroep 17

PE Drukleidingen > PVC Drukleidingen > PP Drukleidingen  
> Afstandbediende afsluiters > C-PVC Programma >  
Blue-system programma > Binnen- en buitenriolering  
> Kabelbescherming en telecom > Milieu programma  
> Tanks > Folie en geotextielen > Halffabrikaten >  
RVS Programma > Malleable programma > Sanitair  
en verwarming > Metalen appendages en fittingen >  
Slangen en koppelingen > Pompen, filters en kabel  
> Lijm, reiniger en toebehoren > Bevestigingsmaterialen >  
Machines en gereedschappen

>> Slangen en koppelingen

# Milder

— VEELZIJDIG IN LEIDINGSYSTEMEN —

# 17.01 Slangen

## Slangen

- Wij wijzen u erop dat de technische gegevens en maatvoeringen indicaties zijn en kunnen afwijken.

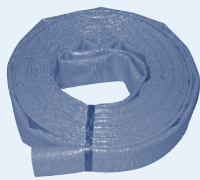
|   | Afmeting    | Rollengte in meter | Artikelnr.  |
|---|-------------|--------------------|-------------|
| <b>9700</b>   | 12,5 (1/2") | 25                 | 97000121025 |
| <b>Tricoflex slang Origineel</b>                                      | 12,5 (1/2") | 50                 | 97000121050 |
| - hoogwaardige waterslang met 5 lagen voor professionele toepassingen | 19 (3/4")   | 25                 | 97000341025 |
| - kleur: geel   | 19 (3/4")   | 50                 | 97000341050 |
| - temperatuur: -20°C + 60°C   | 25 (1")     | 25                 | 97001001025 |
| - zeer slijtvaste en UV bestendige buitenwand                         | 25 (1")     | 50                 | 97001001050 |
| - uitstekende soepelheid  | 30 (1 1/4") | 25                 | 97001141025 |
| - werkdruk: 8-10 bar, barstdruk 20-25 bar                             | 30 (1 1/4") | 50                 | 97001141050 |
|   | 40 (1 1/2") | 25                 | 97001121025 |
|   | 40 (1 1/2") | 50                 | 97001121050 |
|   | 50 (2")     | 25                 | 97002001025 |
|   | 50 (2")     | 50                 | 97002001050 |

Artikelgroep: 17.01.05



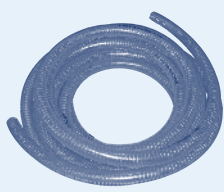
|                       | Afmeting    | Barstdruk in bar | Werkdruk in bar | Artikelnr. |
|-----------------------|-------------|------------------|-----------------|------------|
| <b>9701</b>           | 38 (1 1/2") | 60               | 20              | 9701112    |
| <b>Brandslang</b>     | 52 (2")     | 50               | 17              | 9701200    |
| - kleur: rood         | 64 (2 1/2") | 50               | 17              | 9701212    |
| - zware uitvoering    | 75 (3")     | 50               | 17              | 9701300    |
| - rollengte: 20 meter | 102 (4")    | 40               | 13              | 9701400    |
|                       | 125 (5")    | 30               | 10              | 9701500    |

Artikelgroep: 17.01.05



|                                       | Binnendiameter x buitendiameter in mm | Wanddikte in mm | Werkdruk* in bar | Vacuüm* in bar | Buigradius in mm | Rollengte** in meter | Artikelnr.  |
|---------------------------------------|---------------------------------------|-----------------|------------------|----------------|------------------|----------------------|-------------|
| <b>9710</b>                           | 10 x 16                               | 3               | 7                | 0,8            | 20               | 30                   | 97100100301 |
| <b>PVC Zuig-persslang transparant</b> | 12 x 18                               | 3               | 7                | 0,8            | 25               | 30                   | 97100120301 |
| - inlagen:                            | 14 x 20,4                             | 3,2             | 6                | 0,8            | 30               | 30                   | 97100140301 |
| - stalen spiraal                      | 16 x 22,4 (5/8")                      | 3,2             | 6                | 0,8            | 35               | 30                   | 97100160301 |
| - binnenwand:                         | 18 x 24,4                             | 3,2             | 6                | 0,8            | 40               | 30                   | 97100180301 |
| - glad, transparant                   | 20 x 27 (3/4")                        | 3,5             | 5                | 0,8            | 50               | 30                   | 97100200301 |
| - temperatuur:                        | 25 x 33 (1")                          | 4               | 5                | 0,8            | 75               | 30                   | 97100250301 |
| -10°C/+60°C                           | 32 x 40,4 (1 1/4")                    | 4,2             | 4,5              | 0,8            | 95               | 30                   | 97100320301 |
|                                       | 38 x 47 (1 1/2")                      | 4,5             | 4                | 0,8            | 115              | 30                   | 97100380301 |
|                                       | 40 x 49                               | 4,5             | 3                | 0,8            | 120              | 30                   | 97100400301 |
|                                       | 50 x 60 (2")                          | 5               | 3                | 0,8            | 150              | 30                   | 97100500301 |
|                                       | 63 x 75                               | 6               | 2,5              | 0,7            | 190              | 30                   | 97100630301 |
|                                       | 76 x 90 (3")                          | 7               | 2                | 0,7            | 225              | 30                   | 97100750301 |
|                                       | 80 x 94                               | 7               | 2                | 0,7            | 240              | 30                   | 97100800301 |
|                                       | 102 x 116 (4")                        | 7               | 2                | 0,6            | 300              | 30                   | 97101020301 |

Artikelgroep: 17.01.05



\* Bij een temperatuur van 23°C. Technische gegevens en maatvoeringen zijn indicaties en kunnen afwijken.

\*\* Andere rollengten op aanvraag leverbaar.

## Slangen

|                                    | Binnendiameter x<br>buitendiameter in mm | Werkdruk*<br>in bar | Vacuüm*<br>in bar | Buigradius<br>in mm | Rollengte**<br>in meter | Artikelnr.  |
|------------------------------------|--|---------------------|-------------------|---------------------|-------------------------|-------------|
| <b>9712</b>                        | 20 x 28                                  | 6                   | 0,9               | 80                  | 50                      | 97120200501 |
| <b>PVC Zuig-persslang flexibel</b> | 25 x 32,6                                | 6                   | 0,9               | 100                 | 50                      | 97120250501 |
| - inlagen: PVC spiraal             | 32 x 40,4 (1 1/4")                       | 6                   | 0,9               | 110                 | 50                      | 97120320501 |
| - binnenwand: elastisch PVC,       | 38 x 47 (1 1/2")                         | 6                   | 0,9               | 155                 | 50                      | 97120380501 |
| buitenwand: gegolfd                | 50,8 x 59,8 (2")                         | 4                   | 0,9               | 200                 | 50                      | 97120500501 |
| - temperatuur: -25°C/+60°C         | 63 x 73,9 (2 1/2")                       | 4                   | 0,8               | 250                 | 50                      | 97120630501 |
|                                    | 76 x 87 (3")                             | 4                   | 0,8               | 310                 | 50                      | 97120750501 |
|                                    | 80 x 91                                  | 3                   | 0,8               | 320                 | 50                      | 97120800501 |
|                                    | 102 x 115 (4")                           | 3                   | 0,75              | 400                 | 30                      | 97121000301 |
|                                    | 110 x 124                                | 2,5                 | 0,75              | 450                 | 30                      | 97121100301 |
|                                    | 127 x 142 (5")                           | 2,5                 | 0,7               | 500                 | 20                      | 97121250201 |
|                                    | 152 x 168 (6")                           | 2                   | 0,7               | 600                 | 20                      | 97121500201 |
|                                    | 203 x 225 (8")                           | 1,5                 | 0,6               | 850                 | 10                      | 97122000101 |

Artikelgroep: 17.01.05

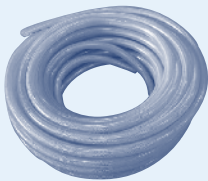


\* Bij een temperatuur van 23°C. Technische gegevens en maatvoeringen zijn indicaties en kunnen afwijken.

\*\* Andere rollengten op aanvraag leverbaar.

|                                     | Binnendiameter x<br>buitendiameter in mm | Werkdruk*<br>in bar | Buigradius<br>in mm | Rollengte**<br>in meter | Artikelnr. |
|-------------------------------------|--|---------------------|---------------------|-------------------------|------------|
| <b>9711</b>                         | 4 x 8                                    | 20                  | 35                  | 100                     | 9711041001 |
| <b>PVC Luchtslang flexibel</b>      | 5 x 11                                   | 20                  | 40                  | 100                     | 9711051001 |
| - kleur: transparant                | 6,3 x 12                                 | 20                  | 50                  | 100                     | 9711061001 |
| - inlagen: textiel                  | 8 x 13                                   | 15                  | 65                  | 100                     | 9711081001 |
| - binnenwand: PVC glad transparant, | 10 x 15 (3/8")                           | 15                  | 80                  | 100                     | 9711101001 |
| buitenwand: PVC glad transparant    | 12,5 x 18 (1/2")                         | 12                  | 95                  | 100                     | 9711121001 |
| - temperatuur: -10°C/+60°C          | 16 x 22                                  | 10                  | 130                 | 50                      | 9711160501 |
| - andere rollengten leverbaar       | 19 x 26 (3/4")                           | 8                   | 155                 | 50                      | 9711190501 |
|                                     | 25 x 33 (1")                             | 8                   | 200                 | 50                      | 9711250501 |
|                                     | 32 x 42 (1 1/4")                         | 5                   | 225                 | 50                      | 9711320501 |
|                                     | 38 x 49 (1 1/2")                         | 5                   | 305                 | 25                      | 9711380251 |
|                                     | 40 x 51                                  | 5                   | 320                 | 25                      | 9711400251 |
|                                     | 50 x 63 (2")                             | 4                   | 400                 | 25                      | 9711500251 |

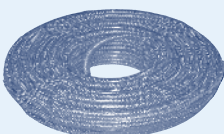
Artikelgroep: 17.01.05



\* Bij een temperatuur van 23°C. Technische gegevens en maatvoeringen zijn indicaties en kunnen afwijken.

\*\* Andere rollengten op aanvraag leverbaar.

|   | Binnendiameter x<br>buitendiameter in mm | Buigradius<br>in mm | Rollengte<br>in meter | Artikelnr.             |
|---|--|---------------------|-----------------------|------------------------|
| <b>9720</b>   | 6 x 12                                   | 48                  | 50                    | 9720006050             |
| <b>Tricoclaire PVC Slang</b>                                      |  |                     |                       | Artikelgroep: 17.01.05 |
| - kleur: blauw transparant  |  |                     |                       |                        |
| - inlagen: polyester  |  |                     |                       |                        |
| - temperatuur: -15°C/+60°C  |  |                     |                       |                        |
| - geschikt voor: o.a. perslucht,<br>levensmiddelen en chemicaliën |  |                     |                       |                        |



Voor bijbehorende koppelingen zie blz. 84, artikelnr. 5363.



# 17.02 Appendages en koppelingen voor slang

## Slangklemmen

|                              | Afmeting in mm         | Artikelnr. |
|------------------------------|------------------------|------------|
| <b>9705</b><br>Wormslangklem | 9 - 12                 | 9705009012 |
|                              | 11 - 16                | 9705011016 |
|                              | 13 - 20                | 9705013020 |
|                              | 14 - 22                | 9705014022 |
|                              | 17 - 25                | 9705017025 |
|                              | 22 - 30                | 9705022030 |
|                              | 25 - 35                | 9705025035 |
|                              | 30 - 40                | 9705030040 |
|                              | 35 - 50                | 9705035050 |
|                              | 40 - 55                | 9705040055 |
|                              | 45 - 60                | 9705045060 |
|                              | 50 - 70                | 9705050070 |
|                              | 60 - 80                | 9705060080 |
|                              | 70 - 90                | 9705070090 |
|                              | 80 - 100               | 9705080100 |
|                              | 90 - 120               | 9705090120 |
|                              | 110 - 140              | 9705110140 |
| 130 - 160                    | 9705130160             |            |
| 190 - 220                    | 9705190220             |            |
|                              | Artikelgroep: 17.02.03 |            |



|                                | Afmeting in mm         | Artikelnr. |
|--------------------------------|------------------------|------------|
| <b>9706</b><br>Super slangklem | 17 - 19                | 9706017019 |
|                                | 20 - 22                | 9706020022 |
|                                | 23 - 25                | 9706023025 |
|                                | 26 - 28                | 9706026028 |
|                                | 29 - 31                | 9706029031 |
|                                | 32 - 35                | 9706032035 |
|                                | 34 - 37                | 9706034037 |
|                                | 36 - 39                | 9706036039 |
|                                | 40 - 43                | 9706040043 |
|                                | 44 - 47                | 9706044047 |
|                                | 48 - 51                | 9706048051 |
|                                | 52 - 55                | 9706052055 |
|                                | 56 - 59                | 9706056059 |
|                                | 60 - 63                | 9706060063 |
|                                | 64 - 67                | 9706064067 |
|                                | 68 - 73                | 9706068073 |
|                                | 74 - 79                | 9706074079 |
|                                | 80 - 85                | 9706080085 |
|                                | 86 - 91                | 9706086091 |
|                                | 92 - 97                | 9706092097 |
|                                | 98 - 103               | 9706098103 |
|                                | 104 - 112              | 9706104112 |
|                                | 113 - 121              | 9706113121 |
|                                | 122 - 130              | 9706122130 |
|                                | 131 - 139              | 9706131139 |
|                                | 140 - 148              | 9706140148 |
|                                | 149 - 161              | 9706149161 |
|                                | 162 - 174              | 9706162174 |
|                                | 175 - 187              | 9706175187 |
|                                | 188 - 200              | 9706188200 |
|                                | 201 - 213              | 9706201213 |
|                                | 214 - 226              | 9706214226 |
|                                | 227 - 239              | 9706227239 |
| 240 - 252                      | 9706240252             |            |
|                                | Artikelgroep: 17.02.03 |            |



|                                       | Afmeting in mm         | Artikelnr. |
|---------------------------------------|------------------------|------------|
| <b>9707</b><br>Wormslangklem<br>- RVS | 9 - 12                 | 9707009012 |
|                                       | 11 - 16                | 9707011016 |
|                                       | 13 - 20                | 9707013020 |
|                                       | 14 - 22                | 9707014022 |
|                                       | 17 - 25                | 9707017025 |
|                                       | 22 - 30                | 9707022030 |
|                                       | 25 - 35                | 9707025035 |
|                                       | 30 - 40                | 9707030040 |
|                                       | 35 - 50                | 9707035050 |
|                                       | 40 - 55                | 9707040055 |
|                                       | 45 - 60                | 9707045060 |
|                                       | 50 - 70                | 9707050070 |
|                                       | 60 - 80                | 9707060080 |
|                                       | 70 - 90                | 9707070090 |
|                                       | 80 - 100               | 9707080100 |
|                                       | 90 - 120               | 9707090120 |
|                                       | 110 - 140              | 9707110140 |
| 130 - 160                             | 9707130160             |            |
|                                       | Artikelgroep: 17.02.03 |            |

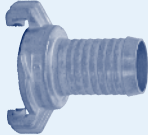


|   | Afmeting in mm         | Artikelnr. |
|---|------------------------|------------|
| <b>9709</b><br>Super slangklem<br>- RVS | 19 - 21                | 9709019021 |
|   | 21 - 23                | 9709021023 |
|   | 23 - 25                | 9709023025 |
|   | 25 - 27                | 9709025027 |
|   | 27 - 29                | 9709027029 |
|   | 29 - 31                | 9709029031 |
|   | 31 - 34                | 9709031034 |
|   | 34 - 37                | 9709034037 |
|   | 37 - 40                | 9709037040 |
|   | 40 - 43                | 9709040043 |
|   | 43 - 47                | 9709043047 |
|   | 47 - 51                | 9709047051 |
|   | 51 - 55                | 9709051055 |
|   | 55 - 59                | 9709055059 |
|   | 59 - 63                | 9709059063 |
|   | 63 - 68                | 9709063068 |
|   | 68 - 73                | 9709068073 |
|   | 73 - 79                | 9709073079 |
|   | 79 - 85                | 9709079085 |
|   | 85 - 91                | 9709085091 |
|   | 91 - 97                | 9709091097 |
|   | 97 - 104               | 9709097104 |
|   | 104 - 112              | 9709104112 |
|   | 112 - 121              | 9709112121 |
|   | 121 - 130              | 9709121130 |
|   | 130 - 140              | 9709130140 |
|   | 149 - 161              | 9709149161 |
| 162 - 174                               | 9709162174             |            |
|   | Artikelgroep: 17.02.03 |            |



## Messing koppelingen type Geka

|   | Afmeting               | Artikelnr. |
|---|------------------------|------------|
| <b>2135</b><br><b>Koppeling type Geka</b><br>- met tule | 3/8"                   | 2135038    |
|   | 5/8"                   | 2135058    |
|   | 1/2"                   | 2135012    |
|   | 3/4"                   | 2135034    |
|   | 1"                     | 2135100    |
|   | 1 1/4"                 | 2135114    |
|   | 1 1/2"                 | 2135112    |
|   | Artikelgroep: 17.02.05 |            |



|  | Afmeting               | Artikelnr. |
|--|------------------------|------------|
| <b>2134</b><br><b>Koppeling type Geka</b><br>- met nastelbare tule | 1/2"                   | 2134012    |
|  | 3/4"                   | 2134034    |
|  | 1"                     | 2134100    |
|  | 1 1/4"                 | 2134114    |
|  | Artikelgroep: 17.02.05 |            |




|  | Afmeting | Artikelnr. |
|--|----------|------------|
| <b>2136</b><br><b>Koppeling type Geka</b><br>- met binnendraad | 3/8"     | 2136038    |
|  | 1/2"     | 2136012    |
|  | 3/4"     | 2136034    |
|  | 1"       | 2136100    |
|  | 1 1/4"   | 2136114    |
|  | 1 1/2"   | 2136112    |
| Artikelgroep: 17.02.05   |          |            |



|  | Afmeting               | Artikelnr. |
|--|------------------------|------------|
| <b>2140</b><br><b>Koppeling type Geka</b><br>- met buitendraad<br>- met automatische afsluiter | 3/4"                   | 2140       |
|  | Artikelgroep: 17.02.05 |            |



|  | Afmeting | Artikelnr. |
|--|----------|------------|
| <b>2137</b><br><b>Koppeling type Geka</b><br>- met buitendraad | 3/8"     | 2137038    |
|  | 1/2"     | 2137012    |
|  | 3/4"     | 2137034    |
|  | 1"       | 2137100    |
|  | 1 1/4"   | 2137114    |
|  | 1 1/2"   | 2137112    |
| Artikelgroep: 17.02.05   |          |            |



|  | Afmeting               | Artikelnr. |
|--|------------------------|------------|
| <b>21751</b><br><b>Y-stuk compleet type Geka</b><br>- 2 x buitendraad,<br>1 x binnendraad<br>- voorzien van 3 koppelingen 3/4" | universeel             | 21751      |
|  | Artikelgroep: 17.02.05 |            |



|  | Afmeting               | Artikelnr. |
|--|------------------------|------------|
| <b>2138</b><br><b>Blindkoppeling type Geka</b> | universeel             | 2138       |
|  | Artikelgroep: 17.02.05 |            |



|   | Afmeting               | Artikelnr. |
|---|------------------------|------------|
| <b>2133</b><br><b>Koppeling type Geka</b><br>- met draaibare tule | 1/2"                   | 2133012    |
|   | 3/4"                   | 2133034    |
|   | Artikelgroep: 17.02.05 |            |



|  | Afmeting               | Artikelnr. |
|--|------------------------|------------|
| <b>2139</b><br><b>Rubber</b><br>- voor messing koppeling type Geka | universeel             | 2139       |
|  | Artikelgroep: 17.02.05 |            |

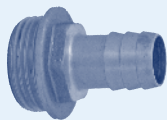


# 17.02 Appendages en koppelingen voor slang

## Messing slangtules

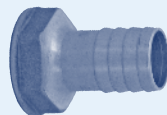
|                          | Afmeting    | Artikelnr. |
|--------------------------|-------------|------------|
| <b>1333</b>              | 1/8" x 6    | 1333018    |
| <b>Messing slangtule</b> | 1/8" x 8    | 133301808  |
| - buitendraad            | 1/8" x 10   | 133301810  |
| - zware uitvoering       | 1/4" x 6    | 133301406  |
| - met zeskant            | 1/4" x 8    | 1333014    |
|                          | 1/4" x 10   | 133301410  |
|                          | 1/4" x 13   | 133301413  |
|                          | 1/4" x 16   | 133301416  |
|                          | 3/8" x 6    | 133303806  |
|                          | 3/8" x 8    | 133303808  |
|                          | 3/8" x 10   | 1333038    |
|                          | 3/8" x 13   | 133303813  |
|                          | 3/8" x 15   | 133303815  |
|                          | 1/2" x 6    | 133301206  |
|                          | 1/2" x 8    | 133301208  |
|                          | 1/2" x 10   | 133301210  |
|                          | 1/2" x 13   | 1333012    |
|                          | 1/2" x 16   | 133301216  |
|                          | 1/2" x 20   | 133301220  |
|                          | 3/4" x 13   | 133303413  |
|                          | 3/4" x 16   | 133303416  |
|                          | 3/4" x 20   | 1333034    |
|                          | 3/4" x 25   | 133303425  |
|                          | 1" x 20     | 133310020  |
|                          | 1" x 25     | 1333100    |
|                          | 1" x 27     | 133310027  |
|                          | 1" x 32     | 133310032  |
|                          | 1 1/4" x 25 | 133311425  |
|                          | 1 1/4" x 30 | 133311430  |
|                          | 1 1/4" x 32 | 1333114    |
|                          | 1 1/4" x 39 | 133311439  |
|                          | 1 1/2" x 32 | 133311232  |
|                          | 1 1/2" x 38 | 1333112    |
|                          | 1 1/2" x 40 | 133311240  |
|                          | 1 1/2" x 45 | 133311245  |
|                          | 1 1/2" x 50 | 133311250  |
|                          | 2" x 51     | 1333200    |
|                          | 2" x 60     | 133320060  |
|                          | 2 1/2" x 63 | 1333212    |
|                          | 2 1/2" x 70 | 133321270  |
|                          | 3" x 76     | 1333300    |
|                          | 4" x 102    | 1333400    |

Artikelgroep: 17.02.10



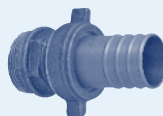
|                          | Afmeting    | Artikelnr. |
|--------------------------|-------------|------------|
| <b>1334</b>              | 1/8" x 8    | 1334018    |
| <b>Messing slangtule</b> | 1/8" x 10   | 133401810  |
| - binnendraad            | 1/4" x 10   | 1334014    |
| - zware uitvoering       | 1/4" x 13   | 133401413  |
| - met zeskant            | 3/8" x 10   | 1334038    |
|                          | 3/8" x 13   | 133403813  |
|                          | 1/2" x 10   | 133401210  |
|                          | 1/2" x 13   | 1334012    |
|                          | 1/2" x 16   | 133401216  |
|                          | 3/4" x 20   | 1334034    |
|                          | 3/4" x 25   | 133403425  |
|                          | 1" x 25     | 1334100    |
|                          | 1 1/4" x 32 | 1334114    |
|                          | 1 1/2" x 40 | 1334112    |
|                          | 2" x 50     | 1334200    |

Artikelgroep: 17.02.10



|  | Afmeting    | Artikelnr. |
|--|-------------|------------|
| <b>1330</b>                            | 3/8" x 10   | 1330038    |
| <b>Messing stand-<br/>pijkoppeling</b> | 1/2" x 13   | 1330012    |
| - buitendraad x<br>wartel x tule       | 1/2" x 15   | 133001215  |
|  | 3/4" x 20   | 1330034    |
|  | 1" x 25     | 1330100    |
|  | 1" x 32     | 133010032  |
|  | 1 1/4" x 32 | 1330114    |
|  | 1 1/4" x 40 | 133011440  |
|  | 1 1/2" x 40 | 133011240  |
|  | 2" x 50     | 1330200    |


Artikelgroep: 17.02.10



# Appendages en koppelingen voor slang 17.02

## Sproeiappendages

|                           | Afmeting | Artikelnr.             |
|---------------------------|----------|------------------------|
| <b>2120</b>               | 1/2"     | 2120012                |
| <b>Messing straalpijp</b> | 3/4"     | 2120034                |
| - instelbaar              | 1"       | 2120100                |
| - met slangtule           | 1 1/4"   | 2120114                |
|                           |          | Artikelgroep: 17.02.15 |



|                            | Artikelnr.             |
|----------------------------|------------------------|
| <b>2062</b>                | 2062                   |
| <b>Aluminium gietbroes</b> | Artikelgroep: 17.02.15 |



|                                | Afmeting in mm | Artikelnr.             |
|--------------------------------|----------------|------------------------|
| <b>2126</b>                    | 3              | 2126300                |
| <b>Aluminium waaierspreier</b> |                | Artikelgroep: 17.02.15 |




|                                   | Afmeting | Artikelnr.             |
|-----------------------------------|----------|------------------------|
| <b>2125</b>                       | 1/2"     | 2125012                |
| <b>Messing straalpijp</b>         | 3/4"     | 2125034                |
| - instelbaar                      | 1"       | 2125100                |
| - met messing koppeling type Geka |          | Artikelgroep: 17.02.15 |



|   | Afmeting | Artikelnr.             |
|---|----------|------------------------|
| <b>2127</b>                                 | 1/2"     | 2127012                |
| <b>Messing verchroomde slangwartelkraan</b> | 3/4"     | 2127034                |
|   |          | Artikelgroep: 17.02.15 |



|                                   | Lengte in mm | Artikelnr.             |
|-----------------------------------|--------------|------------------------|
| <b>2061</b>                       | 400          | 2061040                |
| <b>Gietstok compleet</b>          | 600          | 2061060                |
| - met messing koppeling type Geka | 900          | 2061090                |
| - met kogelkraan                  | 1200         | 2061120                |
|                                   |              | Artikelgroep: 17.02.15 |



# 17.02 Appendages en koppelingen voor slang

## Storz koppelingen lichtmetaal

|   | Afmeting               | Artikelnr. |
|---|------------------------|------------|
| <b>7135</b><br><b>Storz koppeling</b><br>- met tule | NA 44 x 1"             | 7135044100 |
|   | NA 52 x 1 1/4"         | 7135052114 |
|   | NA 52 x 1 1/2"         | 7135052112 |
|   | NA 66 x 1 1/2"         | 7135066112 |
|   | NA 66 x 2"             | 7135066200 |
|   | NA 81 x 2"             | 7135081200 |
|   | NA 81 x 2 1/2"         | 7135081212 |
|   | NA 81 x 3"             | 7135081300 |
|   | NA 89 x 2 1/2"         | 7135089212 |
|   | NA 89 x 3"             | 7135089300 |
|   | NA 115 x 4"            | 7135115400 |
|   | NA 133 x 4"            | 7135133400 |
|   | NA 148 x 5"            | 7135148500 |
|   | Artikelgroep: 17.02.20 |            |



|  | Afmeting | Artikelnr. |
|--|----------|------------|
| <b>7134</b><br><b>Straalpijp</b><br>- lichtmetaal met kogelafsluiter<br>- zonder Storz koppeling | 1"       | 71340      |
|  | 2"       | 7134       |
| Artikelgroep: 17.02.20   |          |            |



|  | Afmeting               | Artikelnr. |
|--|------------------------|------------|
| <b>7136</b><br><b>Storz koppeling</b><br>- met binnendraad | NA 44 x 1"             | 7136044100 |
|  | NA 52 x 1 1/4"         | 7136052114 |
|  | NA 52 x 1 1/2"         | 7136052112 |
|  | NA 66 x 1 1/2"         | 7136066112 |
|  | NA 66 x 2"             | 7136066200 |
|  | NA 81 x 2"             | 7136081200 |
|  | NA 81 x 2 1/2"         | 7136081212 |
|  | NA 81 x 3"             | 7136081300 |
|  | NA 89 x 2"             | 7136089200 |
|  | NA 89 x 2 1/2"         | 7136089212 |
|  | NA 89 x 3"             | 7136089300 |
|  | NA 115 x 4"            | 7136115400 |
|  | NA 133 x 4"            | 7136133400 |
|  | Artikelgroep: 17.02.20 |            |



|  | Afmeting               | Artikelnr. |
|--|------------------------|------------|
| <b>7139</b><br><b>Storz rubber ring</b><br>- voor zuig-persleiding | NA 44                  | 7139044    |
|  | NA 52                  | 7139052    |
|  | NA 66                  | 7139066    |
|  | NA 81                  | 7139081    |
|  | NA 89                  | 7139089    |
|  | NA 115                 | 7139115    |
|  | NA 133                 | 7139133    |
|  | Artikelgroep: 17.02.20 |            |



|   | Afmeting | Artikelnr. |
|---|----------|------------|
| <b>7138</b><br><b>Storz afsluitkap</b><br>- met ketting | NA 44    | 7138044    |
|   | NA 52    | 7138052    |
|   | NA 66    | 7138066    |
|   | NA 81    | 7138081    |
|   | NA 89    | 7138089    |
|   | NA 115   | 7138115    |
|   | NA 133   | 7138133    |
|   | NA 148   | 7138148    |
| Artikelgroep: 17.02.20                                  |          |            |



|                                     | Afmeting               | Artikelnr. |
|-------------------------------------|------------------------|------------|
| <b>7140</b><br><b>Storz sleutel</b> | t/m NA 89              | 7140       |
|                                     | Artikelgroep: 17.02.20 |            |



|  | Afmeting       | Artikelnr. |
|--|----------------|------------|
| <b>7137</b><br><b>Storz koppeling</b><br>- met buitendraad | NA 44 x 1"     | 7137044100 |
|  | NA 44 x 1 1/4" | 7137044114 |
|  | NA 52 x 1 1/4" | 7137052114 |
|  | NA 52 x 1 1/2" | 7137052112 |
|  | NA 66 x 1 1/2" | 7137066112 |
|  | NA 66 x 2"     | 7137066200 |
|  | NA 81 x 2"     | 7137081200 |
|  | NA 81 x 2 1/2" | 7137081212 |
|  | NA 81 x 3"     | 7137081300 |
|  | NA 89 x 2"     | 7137089200 |
|  | NA 89 x 2 1/2" | 7137089212 |
|  | NA 89 x 3"     | 7137089300 |
|  | NA 115 x 4"    | 7137115400 |
|  | NA 133 x 4"    | 7137133400 |
|  | NA 148 x 5"    | 7137148500 |
| Artikelgroep: 17.02.20                                     |                |            |



|                                     | Afmeting               | Artikelnr. |
|-------------------------------------|------------------------|------------|
| <b>7141</b><br><b>Storz sleutel</b> | t/m NA 133             | 7141       |
|                                     | Artikelgroep: 17.02.20 |            |



## Koppelingen type Camlock

- Standaard afdichting: NBR. Andere afdichtingen zijn op aanvraag leverbaar.
- V-deel: 'Vader'-deel, is exclusief klembeugels.
- M-deel: 'Moeder'-deel, is inclusief klembeugels.

|   | Afmeting | Artikelnr. PP | Artikelnr. RVS | Artikelnr. Messing | Artikelnr. Aluminium |
|---|----------|---------------|----------------|--------------------|----------------------|
| <b>7161</b><br><b>Koppeling</b><br><b>type Camlock A</b><br>- met binnendraad<br>- V-deel | 1/2"     |               | 7161RVSA012    | 7161MESA012        | 7161ALUA012          |
|   | 3/4"     | 7161PPPA034   | 7161RVSA034    | 7161MESA034        | 7161ALUA034          |
|   | 1"       | 7161PPPA100   | 7161RVSA100    | 7161MESA100        | 7161ALUA100          |
|   | 1 1/4"   | 7161PPPA114   | 7161RVSA114    | 7161MESA114        | 7161ALUA114          |
|   | 1 1/2"   | 7161PPPA112   | 7161RVSA112    | 7161MESA112        | 7161ALUA112          |
|   | 2"       | 7161PPPA200   | 7161RVSA200    | 7161MESA200        | 7161ALUA200          |
|   | 2 1/2"   |               | 7161RVSA212    | 7161MESA212        | 7161ALUA212          |
|   | 3"       | 7161PPPA300   | 7161RVSA300    | 7161MESA300        | 7161ALUA300          |
|   | 4"       | 7161PPPA400   | 7161RVSA400    | 7161MESA400        | 7161ALUA400          |
|   | 5"       |               | 7161RVSA500    |                    | 7161ALUA500          |
|   | 6"       |               | 7161RVSA600    |                    | 7161ALUA600          |



Artikelgroep: 17.02.25

|   | Afmeting | Artikelnr. PP | Artikelnr. RVS | Artikelnr. Messing | Artikelnr. Aluminium |
|---|----------|---------------|----------------|--------------------|----------------------|
| <b>7162</b><br><b>Koppeling</b><br><b>type Camlock B</b><br>- met buitendraad<br>- M-deel | 1/2"     |               | 7162RVSB012    | 7162MESB012        | 7162ALUB012          |
|   | 3/4"     | 7162PPPB034   | 7162RVSB034    | 7162MESB034        | 7162ALUB034          |
|   | 1"       | 7162PPPB100   | 7162RVSB100    | 7162MESB100        | 7162ALUB100          |
|   | 1 1/4"   | 7162PPPB114   | 7162RVSB114    | 7162MESB114        | 7162ALUB114          |
|   | 1 1/2"   | 7162PPPB112   | 7162RVSB112    | 7162MESB112        | 7162ALUB112          |
|   | 2"       | 7162PPPB200   | 7162RVSB200    | 7162MESB200        | 7162ALUB200          |
|   | 2 1/2"   |               | 7162RVSB212    | 7162MESB212        | 7162ALUB212          |
|   | 3"       | 7162PPPB300   | 7162RVSB300    | 7162MESB300        | 7162ALUB300          |
|   | 4"       | 7162PPPB400   | 7162RVSB400    | 7162MESB400        | 7162ALUB400          |
|   | 5"       |               | 7162RVSB500    |                    | 7162ALUB500          |
|   | 6"       |               | 7162RVSB600    |                    | 7162ALUB600          |



Artikelgroep: 17.02.25

|  | Afmeting | Artikelnr. PP | Artikelnr. RVS | Artikelnr. Messing | Artikelnr. Aluminium |
|--|----------|---------------|----------------|--------------------|----------------------|
| <b>7163</b><br><b>Koppeling</b><br><b>type Camlock C</b><br>- met tule<br>- M-deel | 1/2"     |               | 7163RVSC012    | 7163MESB012        | 7163ALUC012          |
|  | 3/4"     | 7163PPPC034   | 7163RVSC034    | 7163MESB034        | 7163ALUC034          |
|  | 1"       | 7163PPPC100   | 7163RVSC100    | 7163MESB100        | 7163ALUC100          |
|  | 1 1/4"   | 7163PPPC114   | 7163RVSC114    | 7163MESB114        | 7163ALUC114          |
|  | 1 1/2"   | 7163PPPC112   | 7163RVSC112    | 7163MESB112        | 7163ALUC112          |
|  | 2"       | 7163PPPC200   | 7163RVSC200    | 7163MESB200        | 7163ALUC200          |
|  | 2 1/2"   |               | 7163RVSC212    | 7163MESB212        | 7163ALUC212          |
|  | 3"       | 7163PPPC300   | 7163RVSC300    | 7163MESB300        | 7163ALUC300          |
|  | 4"       | 7163PPPC400   | 7163RVSC400    | 7163MESB400        | 7163ALUC400          |
|  | 5"       |               | 7163RVSC500    |                    | 7163ALUC500          |
|  | 6"       |               | 7163RVSC600    |                    | 7163ALUC600          |



Artikelgroep: 17.02.25

|   | Afmeting | Artikelnr. PP | Artikelnr. RVS | Artikelnr. Messing | Artikelnr. Aluminium |
|---|----------|---------------|----------------|--------------------|----------------------|
| <b>7164</b><br><b>Koppeling</b><br><b>type Camlock D</b><br>- met binnendraad<br>- M-deel | 1/2"     |               | 7164RVSD012    | 7164MESD012        | 7164ALUD012          |
|   | 3/4"     | 7164PPPD034   | 7164RVSD034    | 7164MESD034        | 7164ALUD034          |
|   | 1"       | 7164PPPD100   | 7164RVSD100    | 7164MESD100        | 7164ALUD100          |
|   | 1 1/4"   | 7164PPPD114   | 7164RVSD114    | 7164MESD114        | 7164ALUD114          |
|   | 1 1/2"   | 7164PPPD112   | 7164RVSD112    | 7164MESD112        | 7164ALUD112          |
|   | 2"       | 7164PPPD200   | 7164RVSD200    | 7164MESD200        | 7164ALUD200          |
|   | 2 1/2"   |               | 7164RVSD212    | 7164MESD212        | 7164ALUD212          |
|   | 3"       | 7164PPPD300   | 7164RVSD300    | 7164MESD300        | 7164ALUD300          |
|   | 4"       | 7164PPPD400   | 7164RVSD400    | 7164MESD400        | 7164ALUD400          |
|   | 5"       |               | 7164RVSD500    |                    | 7164ALUD500          |
|   | 6"       |               | 7164RVSD600    |                    | 7164ALUD600          |



Artikelgroep: 17.02.25

# 17.02 Appendages en koppelingen voor slang

## Koppelingen type Camlock

|  | Afmeting | Artikelnr. PP | Artikelnr. RVS | Artikelnr. Messing | Artikelnr. Aluminium |
|--|----------|---------------|----------------|--------------------|----------------------|
| <b>7165</b><br><b>Koppeling</b><br><b>type Camlock E</b><br>- met tule<br>- V-deel | 1/2"     | 7165PPPE012   | 7165RVSE012    | 7165MESE012        | 7165ALUE012          |
|  | 3/4"     | 7165PPPE034   | 7165RVSE034    | 7165MESE034        | 7165ALUE034          |
|  | 1"       | 7165PPPE100   | 7165RVSE100    | 7165MESE100        | 7165ALUE100          |
|  | 1 1/4"   | 7165PPPE114   | 7165RVSE114    | 7165MESE114        | 7165ALUE114          |
|  | 1 1/2"   | 7165PPPE112   | 7165RVSE112    | 7165MESE112        | 7165ALUE112          |
|  | 2"       | 7165PPPE200   | 7165RVSE200    | 7165MESE200        | 7165ALUE200          |
|  | 2 1/2"   |               | 7165RVSE212    | 7165MESE212        | 7165ALUE212          |
|  | 3"       | 7165PPPE300   | 7165RVSE300    | 7165MESE300        | 7165ALUE300          |
|  | 4"       | 7165PPPE400   | 7165RVSE400    | 7165MESE400        | 7165ALUE400          |
|  | 5"       |               | 7165RVSE500    |                    | 7165ALUE500          |
| 6"   |          | 7165RVSE600   |                | 7165ALUE600        |                      |



Artikelgroep: 17.02.25

|   | Afmeting | Artikelnr. PP | Artikelnr. RVS | Artikelnr. Messing | Artikelnr. Aluminium |
|---|----------|---------------|----------------|--------------------|----------------------|
| <b>7166</b><br><b>Koppeling</b><br><b>type Camlock F</b><br>- met buitendraad<br>- V-deel | 1/2"     |               | 7166RVSF012    | 7166MESF012        | 7166ALUF012          |
|   | 3/4"     | 7166PPPF034   | 7166RVSF034    | 7166MESF034        | 7166ALUF034          |
|   | 1"       | 7166PPPF100   | 7166RVSF100    | 7166MESF100        | 7166ALUF100          |
|   | 1 1/4"   | 7166PPPF114   | 7166RVSF114    | 7166MESF114        | 7166ALUF114          |
|   | 1 1/2"   | 7166PPPF112   | 7166RVSF112    | 7166MESF112        | 7166ALUF112          |
|   | 2"       | 7166PPPF200   | 7166RVSF200    | 7166MESF200        | 7166ALUF200          |
|   | 2 1/2"   |               | 7166RVSF212    | 7166MESF212        | 7166ALUF212          |
|   | 3"       | 7166PPPF300   | 7166RVSF300    | 7166MESF300        | 7166ALUF300          |
|   | 4"       | 7166PPPF400   | 7166RVSF400    | 7166MESF400        | 7166ALUF400          |
|   | 5"       |               | 7166RVSF500    |                    | 7166ALUF500          |
| 6"  |          | 7166RVSF600   |                | 7166ALUF600        |                      |



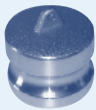
Artikelgroep: 17.02.25

|   | Afmeting | Artikelnr. PP | Artikelnr. RVS | Artikelnr. Messing | Artikelnr. Aluminium |
|---|----------|---------------|----------------|--------------------|----------------------|
| <b>7167</b><br><b>Koppeling</b><br><b>type Camlock DC</b><br>- M-deel | 1/2"     |               | 7167RVSK012    | 7167MESK012        | 7167ALUK012          |
|   | 3/4"     | 7167PPPK034   | 7167RVSK034    | 7167MESK034        | 7167ALUK034          |
|   | 1"       | 7167PPPK100   | 7167RVSK100    | 7167MESK100        | 7167ALUK100          |
|   | 1 1/4"   | 7167PPPK114   | 7167RVSK114    | 7167MESK114        | 7167ALUK114          |
|   | 1 1/2"   | 7167PPPK112   | 7167RVSK112    | 7167MESK112        | 7167ALUK112          |
|   | 2"       | 7167PPPK200   | 7167RVSK200    | 7167MESK200        | 7167ALUK200          |
|   | 2 1/2"   |               | 7167RVSK212    | 7167MESK212        | 7167ALUK212          |
|   | 3"       | 7167PPPK300   | 7167RVSK300    | 7167MESK300        | 7167ALUK300          |
|   | 4"       | 7167PPPK400   | 7167RVSK400    | 7167MESK400        | 7167ALUK400          |
|   | 5"       |               | 7167RVSK500    |                    | 7167ALUK500          |
| 6"  |          | 7167RVSK600   |                | 7167ALUK600        |                      |



Artikelgroep: 17.02.25

|   | Afmeting | Artikelnr. PP | Artikelnr. RVS | Artikelnr. Messing | Artikelnr. Aluminium |
|---|----------|---------------|----------------|--------------------|----------------------|
| <b>7168</b><br><b>Koppeling</b><br><b>type Camlock DP</b><br>- V-deel | 1/2"     |               | 7168RVSP012    | 7168MESP012        | 7168ALUP012          |
|   | 3/4"     | 7168PPPP034   | 7168RVSP034    | 7168MESP034        | 7168ALUP034          |
|   | 1"       | 7168PPPP100   | 7168RVSP100    | 7168MESP100        | 7168ALUP100          |
|   | 1 1/4"   | 7168PPPP114   | 7168RVSP114    | 7168MESP114        | 7168ALUP114          |
|   | 1 1/2"   | 7168PPPP112   | 7168RVSP112    | 7168MESP112        | 7168ALUP112          |
|   | 2"       | 7168PPPP200   | 7168RVSP200    | 7168MESP200        | 7168ALUP200          |
|   | 2 1/2"   |               | 7168RVSP212    | 7168MESP212        | 7168ALUP212          |
|   | 3"       | 7168PPPP300   | 7168RVSP300    | 7168MESP300        | 7168ALUP300          |
|   | 4"       | 7168PPPP400   | 7168RVSP400    | 7168MESP400        | 7168ALUP400          |
|   | 5"       |               | 7168RVSP500    |                    | 7168ALUP500          |
| 6"  |          | 7168RVSP600   |                | 7168ALUP600        |                      |



Artikelgroep: 17.02.25

# Productgroep 18

PE Drukleidingen > PVC Drukleidingen > PP Drukleidingen  
> Afstandbediende afsluiters > C-PVC Programma >  
Blue-system programma > Binnen- en buitenriolering  
> Kabelbescherming en telecom > Milieu programma  
> Tanks > Folie en geotextielen > Halffabrikaten >  
RVS Programma > Malleable programma > Sanitair  
en verwarming > Metalen appendages en fittingen >  
Slangen en koppelingen > Pompen, filters en kabel  
> Lijm, reiniger en toebehoren > Bevestigingsmaterialen >  
Machines en gereedschappen

>> Pompen, filters en kabel

# Milder


— VEELZIJDIG IN LEIDINGSYSTEMEN —



# 18.01 Pompen en filters

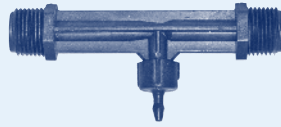
## Pompen

- Onderstaande pompen zijn uit voorraad leverbaar.
- Voor uitgebreide technische informatie vragen wij u contact op te nemen met ons verkoopteam.
- Andere uitvoeringen of modellen zijn op aanvraag leverbaar.

|  | Uitvoering     | Artikelnr. |    |    |    |    |
|--|----------------|------------|----|----|----|----|
| <b>8665</b><br><b>Dompelpomp</b>   | zonder vlotter | 8665       |    |    |    |    |
|  | met vlotter    | 8666       |    |    |    |    |
| Artikelgroep: 18.01.05   |                |            |    |    |    |    |
| <p>Deze dompelpomp is bestemd voor vloeistoffen met een verontreiniging van vaste bestanddelen en uitermate geschikt voor het verpompen van rioolwater met fecaliën, hemel- &amp; drainagewater. Leverbaar in 1x230 Volt of 3x400 Volt*.</p>   |                |            |    |    |    |    |
| <b>Gebruikseigenschappen</b>   |                |            |    |    |    |    |
| <ul style="list-style-type: none"><li>- Maximaal toegestane doorlaat is 50 mm.</li><li>- Maximale dompeldiepte is 20 meter.</li><li>- Maximaal 40 startmomenten per uur.</li><li>- Beschermingsgraad IP68.</li><li>- Isolatieklasse F.</li><li>- Maximale temperatuur van de te verpompen vloeistof: <ul style="list-style-type: none"><li>• 50°C bij continue gebruik S1.</li><li>• 45°C bij niet in continue gebruik S2.</li></ul></li></ul> |                |            |    |    |    |    |
| <b>Constructie</b>   |                |            |    |    |    |    |
| Levering inclusief 10 meter neopreen pompkabel, Nolta stekker met bedrijfscondensator, aan/uit schakelaar deze is tevens de maximaalmotorstroom beveiliging. Koelvloeistof gevuld, asynchroon, 2-polig herwikkelbare motor voorzien van kortsluitanker.  |                |            |    |    |    |    |
| <b>Materialen</b>  |                |            |    |    |    |    |
| <ul style="list-style-type: none"><li>- Trekstangen, handvat, motormantel, bouten en moeren in RVS AISI304.</li><li>- Motoras in RVS AISI416.</li><li>- Deksel en pomphuis in gietijzer EN GJL-250.</li><li>- Afdichtingen in NBR rubber.</li><li>- Waaier in gietijzer EN GJL-200.</li><li>- Mechanical seal in grafiet aluminiumoxide, hardmetaal op aanvraag.</li><li>- Kabel in neopreen H07RN-F.</li></ul>                                |                |            |    |    |    |    |
| <b>Technische data</b>   |                |            |    |    |    |    |
| Voedingsspanning: <ul style="list-style-type: none"><li>• 1 x 230 Volt - 5,5A 50 Hz</li><li>• 3 x 400 Volt - 2,3A 50 Hz</li></ul>  |                |            |    |    |    |    |
| Motorvermogen:   | 0,75 kW / 1 Hp |            |    |    |    |    |
| Toeren per min.:   | 2800           |            |    |    |    |    |
| Persaansluiting:   | 2" binnendraad |            |    |    |    |    |
| Vrije doorlaat:  | 50 mm          |            |    |    |    |    |
| Gewicht:   | 15,7 Kg        |            |    |    |    |    |
| <b>M<sup>3</sup>/H</b>   | 0              | 6          | 12 | 18 | 24 | 30 |
| <b>Opvoerhoogte MWK</b>  | 10,5           | 8,5        | 7  | 5  | 3  | 1  |
|   |                |            |    |    |    |    |
| * 3 x 400 Volt is op aanvraag leverbaar.   |                |            |    |    |    |    |

## Mazzei injectoren

Voor artikelnummers en technische informatie betreffende Mazzei injectoren kunt u contact opnemen met onze verkoopmedewerkers.




## Arkal programma 18.03

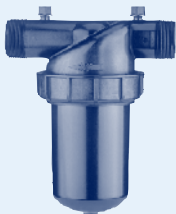
### Arkal programma

- Heeft u interesse in andere filters, neemt u dan contact op met onze afdeling verkoop.

|  | Artikelnr.                      |
|--|---------------------------------|
| <b>1301-1</b><br><b>Arkal filter ¾"</b><br>- standaard met zwart filterelement<br>- maximale werkdruk: 10 bar<br>- met buitendraad | 13011<br>Artikelgroep: 18.03.05 |
|   |                                 |
| <b>Losse filterelementen</b>   | <b>Artikelnr.</b>               |
| zwart - 100 micron   | 13021115                        |
| geel - 200 micron  | 13021200                        |
| blauw - 400 micron   | 13021400                        |
|  | Artikelgroep: 18.03.05          |

|  | Artikelnr.                      |
|--|---------------------------------|
| <b>1311-1</b><br><b>Arkal filter 1"</b><br>- standaard met zwart filterelement<br>- maximale werkdruk: 10 bar<br>- met buitendraad | 13111<br>Artikelgroep: 18.03.05 |
|   |                                 |
| <b>Losse filterelementen</b>   | <b>Artikelnr.</b>               |
| zwart - 100 micron   | 13151115                        |
| rood - 130 micron  | 13151130                        |
| geel - 200 micron  | 13151200                        |
| blauw - 400 micron   | 13151400                        |
|  | Artikelgroep: 18.03.05          |


|  | Artikelnr.                      |
|--|---------------------------------|
| <b>1302-1</b><br><b>Arkal filter ¾"</b><br><b>+ afsluiter</b><br>- standaard met zwart filterelement<br>- maximale werkdruk: 10 bar<br>- met buitendraad<br>- met ingebouwde afsluiter | 13021<br>Artikelgroep: 18.03.05 |
|   |                                 |
| <b>Losse filterelementen</b>   | <b>Artikelnr.</b>               |
| zwart - 100 micron   | 13021115                        |
| geel - 200 micron  | 13021200                        |
| blauw - 400 micron   | 13021400                        |
|  | Artikelgroep: 18.03.05          |

|   | Artikelnr.                      |
|---|---------------------------------|
| <b>1315-1</b><br><b>Arkal filter 1½"</b><br>- standaard met zwart filterelement<br>- maximale werkdruk: 10 bar<br>- met buitendraad | 13151<br>Artikelgroep: 18.03.05 |
|   |                                 |
| <b>Losse filterelementen</b>  | <b>Artikelnr.</b>               |
| zwart - 100 micron  | 13151115                        |
| rood - 130 micron   | 13151130                        |
| geel - 200 micron   | 13151200                        |
| blauw - 400 micron  | 13151400                        |
|   | Artikelgroep: 18.03.05          |

## 18.03 Arkal programma

### Arkal programma

|  | Artikelnr.                      |
|--|---------------------------------|
| <b>1316-1</b><br><b>Arkal Super filter</b><br><b>1½" lang</b><br>- standaard met<br>zwart filterelement<br>- maximale<br>werkdruk: 10 bar<br>- met buitendraad<br>- met extra lang<br>filterdeel | 13161<br>Artikelgroep: 18.03.05 |
|   |                                 |
| <b>Losse<br/>filterelementen</b>   | <b>Artikelnr.</b>               |
| zwart - 100 micron   | 13161115                        |
| rood - 130 micron  | 13161130                        |
| geel - 200 micron  | 13161200                        |
| blauw - 400 micron   | 13161400                        |
|  | Artikelgroep: 18.03.05          |

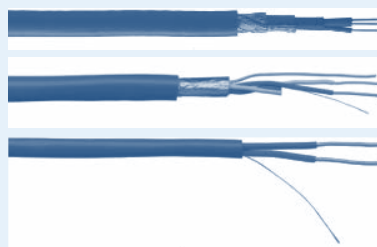
|   | Artikelnr.                      |
|---|---------------------------------|
| <b>1322-1</b><br><b>Arkal dual filter 2"</b><br>- standaard met<br>zwart filterelement<br>- maximale<br>werkdruk: 10 bar<br>- met buitendraad | 13221<br>Artikelgroep: 18.03.05 |
|    |                                 |
| <b>Losse<br/>filterelementen</b>  | <b>Artikelnr.</b>               |
| grijs - 20 micron   | 132211025                       |
| groen - 55 micron   | 132211075                       |
| zwart - 100 micron  | 132211115                       |
| rood - 130 micron   | 132211130                       |
| geel - 200 micron   | 132211200                       |
| blauw - 400 micron  | 132211400                       |
|   | Artikelgroep: 18.03.05          |

|   | Artikelnr.                      |
|---|---------------------------------|
| <b>1337-3</b><br><b>Arkal Angle filter 3"</b><br><b>met flensaansluitingen*</b><br>- standaard met zwart filterelement<br>- maximale werkdruk: 15 bar<br>- metalen filterbuis, epoxy coated<br>- voor sterk bevuilde vloeistoffen | 13373<br>Artikelgroep: 18.03.05 |
|    |                                 |
| * Artikelnr. 13443: Arkal Angle filter 4" met flensaansluitingen.   |                                 |

## 18.04 Kabel

### Kabel

Voor artikelnummers en technische informatie betreffende kabel kunt u contact opnemen met onze verkoopmedewerkers.



# Productgroep 19

PE Drukleidingen > PVC Drukleidingen > PP Drukleidingen  
> Afstandbediende afsluiters > C-PVC Programma >  
Blue-system programma > Binnen- en buitenriolering  
> Kabelbescherming en telecom > Milieu programma  
> Tanks > Folie en geotextielen > Halffabrikaten >  
RVS Programma > Malleable programma > Sanitair  
en verwarming > Metalen appendages en fittingen >  
Slangen en koppelingen > Pompen, filters en kabel  
> Lijm, reiniger en toebehoren > Bevestigingsmaterialen >  
Machines en gereedschappen

>> Lijm, reiniger en toebehoren

# Milder

— VEELZIJDIG IN LEIDINGSYSTEMEN —

# 19.01 Lijm, reiniger en afdichtingsmateriaal

## Lijm

- De keuze van de lijmsort is afhankelijk van de toepassing.
- Wij wijzen u erop dat reinigingsmiddelen zijn vereist voor een goede lijmverbinding.
- Raadpleeg voor gebruik de toepassings- en veiligheidsvoorschriften.

|  | Inhoud in ml | Artikelnr.             |
|--|--------------|------------------------|
| <b>1724</b><br><b>Tangit lijm met drukdeksel</b><br>- voor het lijmen van PVC drukleidingen<br>- KIWA/ATA-keur | blik 1000    | 17241000               |
|  |              | Artikelgroep: 19.01.05 |



|   | Inhoud in ml             | Artikelnr.                   |
|---|--------------------------|------------------------------|
| <b>17121</b><br><b>UNI-100 GT lijm met kwast</b><br>- langzaam drogend<br>- speciaal voor grotere afmetingen<br>- KIWA/ATA-keur | blik 1000<br>blik 5000 * | 171211001000<br>171211005000 |
|   |                          | Artikelgroep: 19.01.05       |




\* Zonder kwast.

|   | Inhoud in ml   | Artikelnr.   |
|---|--|--|
| <b>1723</b><br><b>Tangit lijm met kwast</b><br>- voor het lijmen van PVC drukleidingen<br>- KIWA/ATA-keur | tube 125 *<br>blik 250<br>blik 500<br>blik 1000<br>blik 4500 * | 17230125<br>17230250<br>17230500<br>17231000<br>17234500 |
|   |  | Artikelgroep: 19.01.05                                   |



\* Zonder kwast.

|  | Inhoud in ml  | Artikelnr.   |
|--|---|--|
| <b>17122</b><br><b>UNI-100 XT lijm met kwast</b><br>- THF-vrij | tube 125*<br>pot 250<br>pot 500<br>pot 1000<br>jerrycan 5000* | 171221000125<br>171221000250<br>171221000500<br>171221001000<br>171221005000 |
|  |   | Artikelgroep: 19.01.05   |



\* Zonder kwast.

|  | Inhoud in ml   | Artikelnr.   |
|--|--|--|
| <b>171288</b><br><b>T-88 lijm met kwast</b><br>- voor het lijmen van PVC afvoer- en drukleidingen<br>- KIWA/ATA-keur | pot 100<br>pot 250<br>pot 500<br>pot 1000<br>blik 5000 * | 1712880100<br>1712880250<br>1712880500<br>1712881000<br>1712885000 |
|  |  | Artikelgroep: 19.01.05   |



\* Zonder kwast.

|   | Inhoud in ml | Artikelnr.             |
|---|--------------|------------------------|
| <b>1706</b><br><b>Griffon WDF-05 sneldrogende lijm</b><br>- voor het lijmen van flexibele slangen, PVC afvoer- en drukleidingen | pot 500      | 17060500               |
|   |              | Artikelgroep: 19.01.05 |



|   | Inhoud in ml                                   | Artikelnr.   |
|---|--|--|
| <b>1712100</b><br><b>UNI-100 lijm met kwast</b><br>- voor het lijmen van PVC drukleidingen<br>- KIWA/ATA-keur | pot 250<br>pot 500<br>blik 1000<br>blik 5000 * | 17121000250<br>17121000500<br>17121001000<br>17121005000 |
|   |  | Artikelgroep: 19.01.05                                   |




\* Zonder kwast.

|   | Inhoud in ml | Artikelnr.             |
|---|--------------|------------------------|
| <b>1707</b><br><b>Griffon HCR-36 lijm</b><br>- voor het verlijmen van buizen en fittingen met nauwe passing in druk- en afvoersystemen<br>- tevens geschikt voor C-PVC (max. 60°C)<br>- speciaal voor verbindingen waarbij een hoge chemische bestendigheid is vereist<br>- geschikt voor diameters ≤ 160 mm<br>- max. 10 bar<br>- gebruiken in combinatie met HCR-reiniger zie blz. 269, artikelnr. 1708 | pot 1000     | 17071000               |
|   |              | Artikelgroep: 19.01.05 |



## Lijm

|                                 | Inhoud in ml | Artikelnr.             |
|---------------------------------|--------------|------------------------|
| <b>6149</b><br>Blue-system lijm | pot 250      | 61490250               |
|                                 | pot 1000     | 61491000               |
|                                 |              | Artikelgroep: 06.02.05 |



|                                     | Inhoud in ml | Artikelnr.             |
|-------------------------------------|--------------|------------------------|
| <b>3713</b><br>C-PVC lijm met kwast | pot 500      | 37130500               |
|                                     |              | Artikelgroep: 19.01.05 |



## Reiniger

|   | Inhoud in ml | Artikelnr.             |
|---|--------------|------------------------|
| <b>1725</b><br>Tangit reiniger<br>- voor het reinigen van PVC/C-PVC | blik 1000    | 17251000               |
|   |              | Artikelgroep: 19.01.05 |



|  | Inhoud             | Artikelnr.             |
|--|--------------------|------------------------|
| <b>17111</b><br>Reinigingsdoekjes<br>- geschikt voor PE/PP | flacon à 100 stuks | 171100001              |
|  |                    | Artikelgroep: 19.01.05 |



|  | Inhoud in ml | Artikelnr.             |
|--|--------------|------------------------|
| <b>1713</b><br>Griffon reiniger<br>- voor het reinigen van PVC/C-PVC/Blue-system | blik 125     | 171300125              |
|  | blik 500     | 171300500              |
|  | blik 1000    | 171301000              |
|  | blik 5000    | 171305000              |
|  |              | Artikelgroep: 19.01.05 |



|   | Inhoud in gram | Artikelnr.             |
|---|----------------|------------------------|
| <b>1714</b><br>Glijmiddel<br>- voor fittingen met manchetverbinding<br>- universeel | pot 700        | 1714700                |
|   | pot 4000       | 1714999                |
|   |                | Artikelgroep: 19.01.05 |




|   | Inhoud in ml | Artikelnr.             |
|---|--------------|------------------------|
| <b>1711</b><br>Griffon PE reiniger<br>- voor het reinigen van PE/PP | fles 1000    | 17111000               |
|   |              | Artikelgroep: 19.01.05 |



|                                      | Afmeting in mm | Artikelnr.             |
|--------------------------------------|----------------|------------------------|
| <b>1727</b><br>Kwast<br>- plat model | 30             | 1727030                |
|                                      | 50             | 1727050                |
| <b>1727</b><br>Kwast<br>- rond model | 10             | 1727010                |
|                                      | 12             | 1727012                |
|                                      | 16             | 1727016                |
|                                      | 18             | 1727018                |
|                                      | 20             | 1727020                |
|                                      |                | Artikelgroep: 19.02.05 |



|   | Inhoud in ml | Artikelnr.             |
|---|--------------|------------------------|
| <b>1708</b><br>Griffon HCR-36 reiniger<br>- voor gebruik in combinatie met HCR-lijm zie blz. 268, artikelnr. 1707 | pot 500      | 17080500               |
|   |              | Artikelgroep: 19.01.05 |



|                                      | Afmeting in mm | Artikelnr.             |
|--------------------------------------|----------------|------------------------|
| <b>1727</b><br>Kwast<br>- rond model | 10             | 1727010                |
|                                      | 12             | 1727012                |
|                                      | 16             | 1727016                |
|                                      | 18             | 1727018                |
|                                      | 20             | 1727020                |
|                                      |                | Artikelgroep: 19.02.05 |




# 19.01 Lijm, reiniger en afdichtingsmateriaal


## Afdichtingsmateriaal

- Raadpleeg voor gebruik de toepassings- en veiligheidsvoorschriften.


|   | Inhoud in lengte | Artikelnr.                         |
|---|------------------|------------------------------------|
| <b>1756</b><br>Loctite 55<br>afdichtingskoord | bus à 160 meter  | 17560160<br>Artikelgroep: 19.01.10 |




|                            | Inhoud in ml        | Artikelnr.                                     |
|----------------------------|---------------------|--|
| <b>7570</b><br>Loctite 570 | tube 50<br>tube 250 | 75700050<br>75700250<br>Artikelgroep: 19.01.10 |




|                            | Inhoud in ml        | Artikelnr.                                     |
|----------------------------|---------------------|--|
| <b>7569</b><br>Loctite 577 | tube 50<br>tube 250 | 75690050<br>75690250<br>Artikelgroep: 19.01.10 |



|                                 | Inhoud in ml  | Artikelnr.                         |
|---------------------------------|---------------|------------------------------------|
| <b>7572</b><br>Loctite reiniger | spruitbus 400 | 75720400<br>Artikelgroep: 19.01.10 |




|  | Inhoud in ml | Artikelnr.                     |
|--|--------------|--------------------------------|
| <b>1757</b><br>Tangit M 3000<br>expansieschuim<br>- compleet met<br>1x tuitmond<br>artikel 17573 | 300          | 1757<br>Artikelgroep: 19.01.10 |



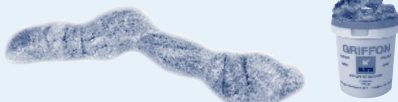
|  | Inhoud in ml | Artikelnr.                         |
|--|--------------|------------------------------------|
| <b>1721</b><br>Siliconenkit<br>- transparant | koker 300    | 17210310<br>Artikelgroep: 19.01.10 |




|   | Lengte in mm | Artikelnr.                      |
|---|--------------|---------------------------------|
| <b>17571</b><br>Tangit M 4082<br>dichtsok | 800          | 17571<br>Artikelgroep: 19.01.10 |



|                       | Inhoud in gram      | Artikelnr.                                     |
|-----------------------|---------------------|--|
| <b>1719</b><br>Hennep | pot 100<br>knot 200 | 17190100<br>17190200<br>Artikelgroep: 19.01.10 |




|   | Artikelnr.                      |
|---|---------------------------------|
| <b>17572</b><br>Tangit PP 06 kitpistool | 17572<br>Artikelgroep: 19.01.10 |




|  | Inhoud in ml | Artikelnr.                          |
|--|--------------|-------------------------------------|
| <b>17211</b><br>Tixophalte<br>- kleur: zwart | koker 310    | 172103101<br>Artikelgroep: 19.01.10 |



|  | Artikelnr.                      |
|--|---------------------------------|
| <b>17573</b><br>Tangit FP 504 tuitmond | 17573<br>Artikelgroep: 19.01.10 |



|                          | Inhoud in kg | Artikelnr.                     |
|--------------------------|--------------|--------------------------------|
| <b>1760</b><br>Moffenkit | 15           | 1760<br>Artikelgroep: 19.01.10 |




## Tape en toebehoren

|  | Afmeting rol l x b x dikte | Artikelnr.             |
|--|----------------------------|------------------------|
| <b>1715</b><br><b>PTFE (Teflon) tape</b><br>- met Gastec QA<br>- kleur: rood | 12 meter x 12mm x 0,1mm    | 1715                   |
|  |                            | Artikelgroep: 19.02.05 |



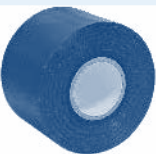
|  | Afmeting rol l x b x dikte | Artikelnr.             |
|--|----------------------------|------------------------|
| <b>17151</b><br><b>PTFE (Teflon) tape</b><br>- DIN EN 751-3<br>- kleur: geel | 12 meter x 12mm x 0,1mm    | 17151                  |
|  | 15 meter x 19mm x 0,2mm    | 17152                  |
|  |                            | Artikelgroep: 19.02.05 |



|   | Breedte in mm | Artikelnr.             |
|---|---------------|------------------------|
| <b>1738</b><br><b>Aluminium tape voor HDPE/ aluminium Buis</b><br>- rollengte: 45 meter | 100           | 1738100                |
|   |               | Artikelgroep: 19.02.05 |



|   | Breedte in mm | Artikelnr.             |
|---|---------------|------------------------|
| <b>1739</b><br><b>PE Tape voor buis</b><br>- rollengte: 15,25 meter | 50            | 1739050                |
|   |               | Artikelgroep: 19.02.05 |



|  | Kleur | Breedte in mm | Artikelnr.             |
|--|-------|---------------|------------------------|
| <b>1718</b><br><b>PVC Isolatie tape</b><br>- dikte: 0,2mm<br>- rollengte: 10 meter | wit   | 50            | 1718105                |
|  | wit   | 100           | 1718110                |
|  | geel  | 50            | 1718205                |
|  | geel  | 100           | 1718210                |
|  | grijs | 50            | 1718305                |
|  | grijs | 100           | 1718310                |
|  | zwart | 50            | 1718405                |
|  | zwart | 100           | 1718410                |
|  |       |               | Artikelgroep: 19.02.05 |



|   | Breedte in mm | Artikelnr.             |
|---|---------------|------------------------|
| <b>Fig. 240</b><br><b>Kebu Petro-band</b><br>- rol à 10 meter | 50            | 403500003              |
|   | 100           | 403500004              |
|   |               | Artikelgroep: 16.02.05 |



|  | Breedte in mm | Artikelnr.             |
|--|---------------|------------------------|
| <b>Fig. 243</b><br><b>Kebu Reparatieband</b><br>- rol à 10 meter | 50            | 403500026              |
|  |               | Artikelgroep: 16.02.05 |



|   | Inhoud in gram | Artikelnr.             |
|---|----------------|------------------------|
| <b>Fig. 246</b><br><b>Kebu Kneedmassa</b> | 500            | 403500046              |
|   |                | Artikelgroep: 16.02.05 |



|   | Inhoud in ml | Artikelnr.             |
|---|--------------|------------------------|
| <b>Fig. 247</b><br><b>Stopaq afdichtings-pasta FN2100</b> | 310          | 401522820              |
|   |              | Artikelgroep: 16.02.05 |






# 19.02 Tape en toebehoren

## Tape en toebehoren

|   | Breedte in mm | Artikelnr.                       |
|---|---------------|----------------------------------|
| <b>1720</b><br>Linnen gecoate tape<br>- waterafstotend<br>- rollengte: 55 meter | 48            | 172005<br>Artikelgroep: 19.02.05 |

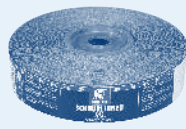


|  | Afmeting rol l x b | Artikelnr.                     |
|--|--------------------|--------------------------------|
| <b>1744</b><br>Griffon Kolmat<br>Fibre Seal tape | 15 meter x 14mm    | 1744<br>Artikelgroep: 19.02.05 |



|   | Type             | Artikelnr. |
|---|------------------|------------|
| <b>1736</b><br>Schuurlinnen<br>- breedte: 38mm<br>- rollengte: 25 meter | K-80             | 1736081    |
|   | K-80 waterproof  | 1736082    |
|   | K-120            | 1736121    |
|   | K-120 waterproof | 1736122    |


Artikelgroep: 19.02.05



|                           | Inhoud in gram | Artikelnr.                     |
|---------------------------|----------------|--------------------------------|
| <b>1717</b><br>Fitterskit | pot 600        | 1717<br>Artikelgroep: 19.02.05 |




|                                    | Inhoud in gram | Artikelnr.                        |
|------------------------------------|----------------|-----------------------------------|
| <b>1729</b><br>Glijmiddel Blue Gel | knijpfles 250  | 1729250<br>Artikelgroep: 19.01.05 |



|                             | Inhoud in ml  | Artikelnr.                     |
|-----------------------------|---------------|--------------------------------|
| <b>1740</b><br>Gaslekzoeker | spruitbus 400 | 1740<br>Artikelgroep: 19.02.05 |



|                           | Artikelnr.                     |
|---------------------------|--------------------------------|
| <b>1722</b><br>Kitpistool | 1722<br>Artikelgroep: 19.02.05 |



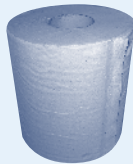
|   | Type                             | Artikelnr.                      |
|---|----------------------------------|---------------------------------|
| <b>1794</b><br>Werkhandschoenen<br>- per paar | Grijs met ruwe, blauwe latexlaag | 17940                           |
|   | Amerikaantje                     | 17941<br>Artikelgroep: 19.02.05 |




|  | Inhoud         | Artikelnr.                     |
|--|----------------|--------------------------------|
| <b>1798</b><br>Poetsdoeken<br>- afmeting doek: 34 x 37cm | doos 250 stuks | 1798<br>Artikelgroep: 19.02.05 |



|  | Artikelnr.                      |
|--|---------------------------------|
| <b>17982</b><br>Poetspapier<br>- kleur: wit<br>- per rol | 17982<br>Artikelgroep: 19.02.05 |



|   | Inhoud in ml | Artikelnr.                     |
|---|--------------|--------------------------------|
| <b>1800</b><br>Handzeep<br>- inclusief pompje | 3000         | 1800<br>Artikelgroep: 19.02.05 |



# Productgroep 20

PE Drukleidingen > PVC Drukleidingen > PP Drukleidingen  
> Afstandbediende afsluiters > C-PVC Programma >  
Blue-system programma > Binnen- en buitenriolering  
> Kabelbescherming en telecom > Milieu programma  
> Tanks > Folie en geotextielen > Halffabrikaten >  
RVS Programma > Malleable programma > Sanitair  
en verwarming > Metalen appendages en fittingen >  
Slangen en koppelingen > Pompen, filters en kabel  
> Lijm, reiniger en toebehoren > Bevestigingsmaterialen >  
Machines en gereedschappen

>> Bevestigingsmaterialen

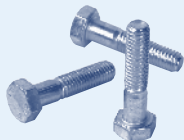
# Milder

— VEELZIJDIG IN LEIDINGSYSTEMEN —

# 20.01 Bouten, moeren en sluitringen

## Verzinkte bouten, moeren en sluitringen

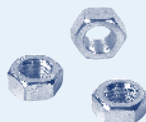
|                              | Afmeting x lengte<br>in mm | Artikelnr.   |
|------------------------------|----------------------------|--------------|
| <b>5904</b>                  | M4 x 40                    | 5904004040   |
| <b>Bout</b>                  | M4 x 50                    | 5904004050   |
| - elektrolytisch<br>verzinkt | M5 x 50                    | 5904005050   |
| - kwaliteit: 8.8             | M6 x 40                    | 5904006040   |
|                              | M6 x 45                    | 5904006045   |
|                              | M8 x 45                    | 5904008045   |
|                              | M8 x 50                    | 5904008050   |
|                              | M8 x 60                    | 5904008060   |
|                              | M8 x 70                    | 5904008070   |
|                              | M8 x 80                    | 5904008080   |
|                              | M10 x 30                   | 5904010030   |
|                              | M10 x 40                   | 5904010040   |
|                              | M10 x 50                   | 5904010050   |
|                              | M10 x 60                   | 5904010060   |
|                              | M10 x 70                   | 5904010070   |
|                              | M10 x 80                   | 5904010080   |
|                              | M10 x 100                  | 5904010100   |
|                              | M12 x 60                   | 5904012060   |
|                              | M12 x 70                   | 5904012070   |
|                              | M12 x 80                   | 5904012080   |
|                              | M12 x 100                  | 5904012100   |
|                              | M16 x 55                   | 5904016055   |
|                              | M16 x 60                   | 5904016060   |
|                              | M16 x 65                   | 5904016065   |
|                              | M16 x 70                   | 5904016070   |
|                              | M16 x 80                   | 5904016080   |
|                              | M16 x 90                   | 5904016090   |
|                              | M16 x 100                  | 5904016100   |
|                              | M16 x 110                  | 5904016110   |
|                              | M16 x 120                  | 5904016120   |
|                              | M16 x 130                  | 5904016130   |
|                              | M16 x 140                  | 5904016140   |
|                              | M16 x 150                  | 5904016150   |
|                              | M16 x 160                  | 5904016160   |
|                              | M16 x 170                  | 5904016170   |
|                              | M16 x 180                  | 5904016180   |
|                              | M16 x 200                  | 5904016200   |
|                              | M16 x 220                  | 5904016220   |
|                              | M20 x 60                   | 5904020060   |
|                              | M20 x 70                   | 5904020070   |
|                              | M20 x 80                   | 5904020080   |
|                              | M20 x 90                   | 5904020090   |
|                              | M20 x 100                  | 5904020100   |
|                              | M20 x 110                  | 5904020110   |
|                              | M20 x 120                  | 5904020120   |
|                              | M20 x 130                  | 5904020130   |
|                              | M20 x 140                  | 5904020140   |
|                              | M20 x 150                  | 5904020150   |
|                              | M20 x 160                  | 5904020160   |
|                              | M20 x 170                  | 5904020170   |
|                              | M20 x 180                  | 5904020180   |
|                              | M20 x 200                  | 5904020200   |
|                              | M20 x 220                  | 5904020220   |
|                              | M20 x 240                  | 5904020240   |
|                              | M20 x 260                  | 5904020260   |
|                              | M24 x 70                   | 5904024070   |
|                              | M24 x 80                   | 5904024080   |
|                              | M24 x 85                   | 5904024085   |
|                              | M24 x 90                   | 5904024090   |
|                              | M24 x 95                   | 5904024095   |
|                              | M24 x 100                  | 5904024100   |
|                              | M24 x 110                  | 5904024110   |
|                              | M24 x 120                  | 5904024120   |
|                              | M24 x 130                  | 5904024130   |
|                              | M24 x 140                  | 5904024140   |
|                              | M24 x 150                  | 5904024150   |
|                              | M24 x 160                  | 5904024160   |
|                              | M24 x 200                  | 5904024200   |
|                              | M24 x 220                  | 5904024220 ↗ |



|                     | Afmeting x lengte<br>in mm | Artikelnr. |
|---------------------|----------------------------|------------|
| <b>Vervolg 5904</b> | M27 x 110                  | 5904027110 |
|                     | M27 x 120                  | 5904027120 |
|                     | M27 x 130                  | 5904027130 |
|                     | M27 x 180                  | 5904027180 |
|                     | M27 x 190                  | 5904027190 |
|                     | M27 x 200                  | 5904027200 |
|                     | M27 x 270                  | 5904027270 |

Artikelgroep: 20.01.05

|                              | Afmeting | Artikelnr. |
|------------------------------|----------|------------|
| <b>5905</b>                  | M6       | 5905006    |
| <b>Moer</b>                  | M8       | 5905008    |
| - elektrolytisch<br>verzinkt | M10      | 5905010    |
| - kwaliteit: 8.8             | M12      | 5905012    |
|                              | M16      | 5905016    |
|                              | M20      | 5905020    |
|                              | M24      | 5905024    |
|                              | M27      | 5905027    |



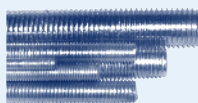
Artikelgroep: 20.01.05

|                              | Afmeting | Artikelnr. |
|------------------------------|----------|------------|
| <b>5906</b>                  | M6       | 5906006    |
| <b>Sluitring</b>             | M8       | 5906008    |
| - elektrolytisch<br>verzinkt | M10      | 5906010    |
| - kwaliteit: 8.8             | M12      | 5906012    |
|                              | M16      | 5906016    |
|                              | M20      | 5906020    |
|                              | M24      | 5906024    |
|                              | M27      | 5906027    |



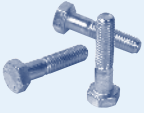
Artikelgroep: 20.01.05

|                              | Afmeting | Artikelnr. |
|------------------------------|----------|------------|
| <b>5908</b>                  | M4       | 5908004    |
| <b>Draadstang</b>            | M5       | 5908005    |
| - elektrolytisch<br>verzinkt | M6       | 5908006    |
| - lengte: 1000mm             | M8       | 5908008    |
| - kwaliteit: 4.8             | M10      | 5908010    |
|                              | M12      | 5908012    |
|                              | M14      | 5908014    |
|                              | M16      | 5908016    |
|                              | M18      | 5908018    |
|                              | M20      | 5908020    |

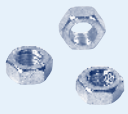



Artikelgroep: 20.01.05


## RVS Bouten, moeren en sluitringen

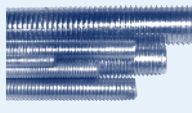
|   | Afmeting x lengte<br>in mm | Artikelnr.  |
|---|----------------------------|-------------|
| <b>59041</b><br><b>RVS Bout</b><br>- kwaliteit: A4<br> | M8 x 20                    | 59041008020 |
|   | M8 x 25                    | 59041008025 |
|   | M8 x 30                    | 59041008030 |
|   | M8 x 35                    | 59041008035 |
|   | M8 x 40                    | 59041008040 |
|   | M8 x 45                    | 59041008045 |
|   | M8 x 50                    | 59041008050 |
|   | M8 x 60                    | 59041008060 |
|   | M8 x 70                    | 59041008070 |
|   | M8 x 80                    | 59041008080 |
|   | M10 x 20                   | 59041010020 |
|   | M10 x 25                   | 59041010025 |
|   | M10 x 30                   | 59041010030 |
|   | M10 x 40                   | 59041010040 |
|   | M10 x 50                   | 59041010050 |
|   | M10 x 60                   | 59041010060 |
|   | M10 x 70                   | 59041010070 |
|   | M10 x 80                   | 59041010080 |
|   | M10 x 100                  | 59041010100 |
|   | M12 x 25                   | 59041012025 |
|   | M12 x 40                   | 59041012040 |
|   | M12 x 50                   | 59041012050 |
|   | M12 x 60                   | 59041012060 |
|   | M12 x 65                   | 59041012065 |
|   | M12 x 70                   | 59041012070 |
|   | M12 x 80                   | 59041012080 |
|   | M12 x 100                  | 59041012100 |
|   | M12 x 120                  | 59041012120 |
|   | M12 x 130                  | 59041012130 |
|   | M12 x 150                  | 59041012150 |
|   | M16 x 30                   | 59041016030 |
|   | M16 x 45                   | 59041016045 |
|   | M16 x 50                   | 59041016050 |
|   | M16 x 55                   | 59041016055 |
|   | M16 x 60                   | 59041016060 |
|   | M16 x 65                   | 59041016065 |
|   | M16 x 70                   | 59041016070 |
|   | M16 x 75                   | 59041016075 |
|   | M16 x 80                   | 59041016080 |
|   | M16 x 85                   | 59041016085 |
|   | M16 x 90                   | 59041016090 |
|   | M16 x 95                   | 59041016095 |
|   | M16 x 100                  | 59041016100 |
|   | M16 x 110                  | 59041016110 |
|   | M16 x 120                  | 59041016120 |
| M16 x 130   | 59041016130                |             |
| M16 x 140   | 59041016140                |             |
| M16 x 150   | 59041016150                |             |
| M16 x 160   | 59041016160                |             |
| M16 x 170   | 59041016170                |             |
| M16 x 180   | 59041016180                |             |
| M16 x 200   | 59041016200                |             |
| M16 x 220   | 59041016220                |             |
| M20 x 45  | 59041020045                |             |
| M20 x 60  | 59041020060                |             |
| M20 x 70  | 59041020070                |             |
| M20 x 80  | 59041020080                |             |
| M20 x 90  | 59041020090                |             |
| M20 x 100   | 59041020100                |             |
| M20 x 110   | 59041020110                |             |
| M20 x 120   | 59041020120                |             |
| M20 x 130   | 59041020130                |             |
| M20 x 140   | 59041020140                |             |
| M20 x 150   | 59041020150                |             |
| M20 x 160   | 59041020160                |             |
| M20 x 180   | 59041020180                |             |
| M20 x 200   | 59041020200                |             |
| M20 x 220   | 59041020220                |             |
| M20 x 300   | 59041020300                |             |
| M24 x 100   | 59041024100                |             |
| M24 x 110   | 59041024110                |             |
| M24 x 120   | 59041024120                |             |
| M24 x 130   | 59041024130                |             |
| M24 x 140   | 59041024140                |             |
| M24 x 150   | 59041024150 ➤              |             |


|                      | Afmeting x lengte<br>in mm | Artikelnr.  |                        |
|----------------------|----------------------------|-------------|------------------------|
| <b>Vervolg 59041</b> | M27 x 110                  | 59041027110 |                        |
|                      | M27 x 120                  | 59041027120 |                        |
|                      | M27 x 130                  | 59041027130 |                        |
|                      | M27 x 180                  | 59041027180 |                        |
|                      | M27 x 190                  | 59041027190 |                        |
|                      | M27 x 200                  | 59041027200 |                        |
|                      | M27 x 270                  | 59041027270 |                        |
|                      |                            |             | Artikelgroep: 20.01.10 |

|   | Afmeting | Artikelnr. |                        |
|---|----------|------------|------------------------|
| <b>59051</b><br><b>RVS Moer</b><br>- kwaliteit: A4<br> | M6       | 59051006   |                        |
|   | M8       | 59051008   |                        |
|   | M10      | 59051010   |                        |
|   | M12      | 59051012   |                        |
|   | M16      | 59051016   |                        |
|   | M20      | 59051020   |                        |
|   | M24      | 59051024   |                        |
|   | M27      | 59051027   |                        |
|   |          |            | Artikelgroep: 20.01.10 |

|  | Afmeting | Artikelnr. |                        |
|--|----------|------------|------------------------|
| <b>59061</b><br><b>RVS Sluitring</b><br>- kwaliteit: A4<br> | M8       | 59061008   |                        |
|  | M10      | 59061010   |                        |
|  | M12      | 59061012   |                        |
|  | M16      | 59061016   |                        |
|  | M20      | 59061020   |                        |
|  | M24      | 59061024   |                        |
|  | M27      | 59061027   |                        |
|  |          |            | Artikelgroep: 20.01.10 |

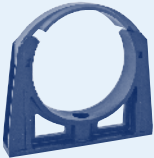
|   | Afmeting | Artikelnr. |
|---|----------|------------|
| <b>590611</b><br><b>RVS Carrosserie-<br/>ring</b><br>- kwaliteit: A4<br> | M8       | 590610081  |
|   | M10      | 590610101  |
|   | M12      | 590610121  |
|   | M20      | 590610201  |
|   |          |            |

|   | Afmeting | Artikelnr.             |
|---|----------|------------------------|
| <b>5909</b><br><b>RVS Draadstang</b><br>- lengte: 1000mm<br>- kwaliteit: A4<br> | M6       | 5909006                |
|   | M8       | 5909008                |
|   | M10      | 5909010                |
|   | M12      | 5909012                |
|   | M16      | 5909016                |
|   | M20      | 5909020                |
|   | M24      | 5909024                |
|   |          | Artikelgroep: 20.01.10 |

|   | Afmeting | Artikelnr. |
|---|----------|------------|
| <b>5910</b><br><b>RVS Slaganker</b><br>- kwaliteit: A4<br> | M8       | 5910008    |
|   | M10      | 5910010    |
|   | M12      | 5910012    |
|   |          |            |

# 20.02 Beugels en toebehoren

## Kunststof beugels

|   | Afmeting in mm         | Artikelnr. |
|---|------------------------|------------|
| <b>5913</b><br>Buis-klem<br> | 12*                    | 5913012    |
|   | 16*                    | 5913016    |
|   | 20*                    | 5913020    |
|   | 25*                    | 5913025    |
|   | 32*                    | 5913032    |
|   | 40                     | 5913040    |
|   | 50                     | 5913050    |
|   | 63                     | 5913063    |
|   | 75                     | 5913075    |
|   | 90                     | 5913090    |
|   | 110                    | 5913110    |
|   | 125                    | 5913125    |
|   | 140                    | 5913140    |
|   | 160                    | 5913160    |
|   | 200                    | 5913200    |
|   | 225                    | 5913225    |
|   | 250                    | 5913250    |
| 315   | 5913315                |            |
| 400**   | 5913400                |            |
|   | Artikelgroep: 20.02.05 |            |

\* Zonder beugel.  
\*\* PP met scharnierend gedeelte.

|  | Afmeting in mm         | Artikelnr. |
|--|------------------------|------------|
| <b>9383</b><br>PVC Beugel<br>- kleur: grijs<br>- zonder pen<br> | 32                     | 9383032    |
|  | 40                     | 9383040    |
|  | 50                     | 9383050    |
|  | 60                     | 9383060    |
|  | 63                     | 9383063    |
|  | 70                     | 9383070    |
|  | 75                     | 9383075    |
|  | 80                     | 9383080    |
|  | 90                     | 9383090    |
|  | 100                    | 9383100    |
|  | 110                    | 9383110    |
|  | 125                    | 9383125    |
|  | 160                    | 9383160    |
| 200  | 9383200                |            |
|  | Artikelgroep: 20.02.05 |            |

|  | Afmeting in mm | Artikelnr.             |
|--|----------------|------------------------|
| <b>9389</b><br>PVC Zadel<br>- omega-model<br> | 25             | 9389025                |
|  | 32             | 9389032                |
|  | 40             | 9389040                |
|  | 50             | 9389050                |
|  | 63             | 9389063                |
|  | 75             | 9389075                |
|  | 80             | 9389080                |
|  | 100            | 9389100                |
|  | 110            | 9389110                |
|  |                | Artikelgroep: 20.02.05 |

|   | Afmeting | Artikelnr.             |
|---|----------|------------------------|
| <b>9388</b><br>Kunststof klemnok<br> | M6       | 93886                  |
|   | M8       | 93888                  |
|   |          | Artikelgroep: 20.02.20 |

|   | Lengte in mm | Artikelnr.             |
|---|--------------|------------------------|
| <b>9485</b><br>Muurpen<br>- voor PVC beugel<br>- thermisch verzinkt<br> | 65           | 9485065                |
|   |              | Artikelgroep: 20.02.20 |

|  | Bereik in mm | Artikelnr.             |
|--|--------------|------------------------|
| <b>5914</b><br>PP Buis-klem<br>- verhogingsblokjes om leiding/afsluiters op gelijke hoogte te brengen<br>- ribben om de klemmen te openen<br>- zowel te gebruiken voor metrische als duimse buisdiameters<br>- steekverbinding om klemmen naar elkaar te verbinden<br>- met 3 schroeven vast te zetten en voorzien van markeringen om aan te geven waar geboord moet worden<br> | 16 - 19      | 5914016019             |
|  | 20 - 23      | 5914020023             |
|  | 25 - 28      | 5914025028             |
|  | 31 - 35      | 5914031035             |
|  | 39 - 43      | 5914039043             |
|  | 47 - 51      | 5914047051             |
|  | 60 - 65      | 5914060065             |
|  | 72 - 80      | 5914072080             |
|  | 87 - 95      | 5914087095             |
|  |              | Artikelgroep: 20.02.05 |

Voor zware industriebeugels zie blz. 278, artikelnr. 4383.

|  | Bereik in mm | Artikelnr.             |  |
|--|--------------|------------------------|--|
| <b>5915</b><br>Buis-klem zelfsluitend<br>- buis-klem sluit als de buis er in gedrukt wordt<br>- bevestiging met houtdraadpen, houtschroef of inlagschroef<br>- UV- en verouderingsbestendig<br>- aan te bevelen voor koperen buis<br> | 12 - 14      | 5915012014             |  |
|  | 14 - 16      | 5915015016             |  |
|  | 16 - 20      | 5915016020             |  |
|  | 20 - 23      | 5915020023             |  |
|  | 24 - 28      | 5915025028             |  |
|  | 32 - 35      | 5915032035             |  |
|  | 40 - 44      | 5915040044             |  |
|  | 48 - 55      | 5915050054             |  |
|  |              | Artikelgroep: 20.02.05 |  |

## Flamco beugels

|                          | Afmeting          | Artikelnr.             |
|--------------------------|-------------------|------------------------|
| <b>2502</b>              | M8 x 1/2" - 22    | 2502008012             |
| <b>Flamco muurbeugel</b> | M8 x 3/4" - 22    | 2502008034             |
|                          | M8 x 1" - 22      | 2502008100             |
|                          | M10 x 1 1/4" - 42 | 2502010114             |
|                          | M10 x 1 1/2" - 42 | 2502010112             |
|                          | M10 x 2" - 42     | 2502010200             |
|                          |                   | Artikelgroep: 20.02.10 |



|                          | Afmeting | Artikelnr.             |
|--------------------------|----------|------------------------|
| <b>2503</b>              | M8 x 12  | 2503008012             |
| <b>Flamco muurbeugel</b> | M8 x 15  | 2503008015             |
|                          | M8 x 22  | 2503008022             |
|                          | M8 x 28  | 2503008028             |
|                          | M8 x 35  | 2503008035             |
|                          | M10 x 42 | 2503010042             |
|                          | M10 x 54 | 2503010054             |
|                          |          | Artikelgroep: 20.02.10 |



## Stalen beugels

|                         | Afmeting  | Artikelnr.             |
|-------------------------|-----------|------------------------|
| <b>9384</b>             | M6 x 25   | 9384025                |
| <b>Stalen beugel EV</b> | M8 x 32   | 9384032                |
| - elektrolytisch        | M8 x 40   | 9384040                |
| verzinkt                | M8 x 50   | 9384050                |
|                         | M8 x 63   | 9384063                |
|                         | M8 x 70   | 9384070                |
|                         | M8 x 75   | 9384075                |
|                         | M8 x 80   | 9384080                |
|                         | M8 x 90   | 9384090                |
|                         | M8 x 100  | 9384100                |
|                         | M8 x 110  | 9384110                |
|                         | M8 x 125  | 9384125                |
|                         | M8 x 140  | 9384140                |
|                         | M8 x 160  | 9384160                |
|                         | M8 x 200  | 9384200                |
|                         | M10 x 225 | 9384225                |
|                         | M10 x 250 | 9384250                |
|                         | M10 x 315 | 9384315                |
|                         |           | Artikelgroep: 20.02.15 |



|                         | Bereik in mm          | Artikelnr.             |
|-------------------------|-----------------------|------------------------|
| <b>9482</b>             | 10 - 14 DN8 (1/4")    | 9482010014             |
| <b>Verzinkte beugel</b> | 15 - 19 DN10 (3/8")   | 9482015019             |
| - met rubber inlage     | 20 - 23 DN15 (1/2")   | 9482020023             |
| - M8/M10                | 25 - 28 DN20 (3/4")   | 9482025028             |
|                         | 31 - 35 DN25 (1")     | 9482031035             |
|                         | 40 - 45 DN32 (1 1/4") | 9482040045             |
|                         | 48 - 52 DN40 (1 1/2") | 9482048052             |
|                         | 60 - 64 DN50 (2")     | 9482060064             |
|                         | 66 - 70               | 9482066070             |
|                         | 75 - 79 DN65 (2 1/2") | 9482075079             |
|                         | 80 - 83               | 9482080083             |
|                         | 88 - 91 DN80 (3")     | 9482088091             |
|                         | 100 - 105             | 9482100105             |
|                         | 108 - 115 DN100 (4")  | 9482108115             |
|                         | 125 - 130             | 9482125130             |
|                         | 133 - 140 DN125 (5")  | 9482133140             |
|                         | 152 - 160             | 9482152160             |
|                         | 165 - 169 DN150 (6")  | 9482165169             |
|                         | 200 - 210             | 9482200210             |
|                         |                       | Artikelgroep: 20.02.15 |



|                         | Afmeting   | Artikelnr.             |
|-------------------------|------------|------------------------|
| <b>93841</b>            | M8 x 70    | 93841070               |
| <b>Stalen beugel TV</b> | M8 x 80    | 93841080               |
| - thermisch verzinkt    | M8 x 100   | 93841100               |
|                         | 250 Gat 13 | 93841250               |
|                         | 315 Gat 13 | 93841315               |
|                         |            | Artikelgroep: 20.02.15 |



# 20.02 Beugels en toebehoren

## Zware industriebeugels

|  | Afmeting   | Artikelnr. |
|--|------------|------------|
| <b>4383</b><br><b>Zware industrie-beugel</b><br>- elektrolytisch<br>verzinkt | 90 x 1/2"  | 4383090    |
|  | 110 x 1/2" | 4383110    |
|  | 125 x 1/2" | 4383125    |
|  | 140 x 1/2" | 4383140    |
|  | 160 x 1/2" | 4383160    |
|  | 160 x 1"   | 43831601   |
|  | 200 x 1" * | 4383200    |
|  | 225 x 1" * | 4383225    |
|  | 250 x 1" * | 4383250    |
|  | 315 x 1" * | 4383315    |
| Artikelgroep: 20.02.15   |            |            |



\* Met sok.

|  | Afmeting               | Artikelnr. |
|--|------------------------|------------|
| <b>4384</b><br><b>Muurplaat</b><br>- elektrolytisch<br>verzinkt<br>- 1/2" en 1" zijn<br>voor zware industrie-beugel (artikel-nr. 4383)<br>- M6 t/m M16 zijn uitgevoerd met projectiegelaste aansluitmoer | 1/2"                   | 4384012    |
|  | 1"                     | 4384100    |
|  | M6                     | 4384006    |
|  | M8                     | 4384008    |
|  | M10                    | 4384010    |
|  | M16                    | 4384016    |
|  | Artikelgroep: 20.02.20 |            |

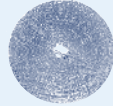


## Toebehoren voor beugels

|                           | Afmeting | Artikelnr.             |
|---------------------------|----------|------------------------|
| <b>9390</b><br>Montageoog | M6       | 93906                  |
|                           | M8       | 93908                  |
|                           |          | Artikelgroep: 20.02.20 |



|  | Breedte in mm | Artikelnr.             |
|--|---------------|------------------------|
| <b>93871</b><br>Kunststof<br>ophangband<br>- rollengte: 25 meter | 40            | 93871                  |
|  |               | Artikelgroep: 20.02.20 |



|   | Afmeting x lengte<br>in mm | Artikelnr.             |
|---|----------------------------|------------------------|
| <b>93901</b><br>Draadbus verzinkt<br>- elektrolytisch<br>verzinkt | M6 x 25                    | 9390106025             |
|   | M8 x 30                    | 9390108030             |
|   | M10 x 30                   | 9390110030             |
|   | M12 x 40                   | 9390112040             |
|   |                            | Artikelgroep: 20.02.20 |




|   | Afmeting x lengte<br>in mm | Artikelnr.             |
|---|----------------------------|------------------------|
| <b>9386</b><br>Houtdraadpen<br>- elektrolytisch<br>verzinkt | M6 x 60                    | 9386006060             |
|   | M6 x 90                    | 9386006090             |
|   | M6 x 150                   | 9386006150             |
|   | M8 x 50                    | 9386008050             |
|   | M8 x 80                    | 9386008080             |
|   | M8 x 100                   | 9386008100             |
|   | M8 x 150                   | 9386008150             |
|   |                            | Artikelgroep: 20.02.20 |



|   | Afmeting | Artikelnr.             |
|---|----------|------------------------|
| <b>93902</b><br>Verloopnippel<br>- elektrolytisch<br>verzinkt<br>- buitendraad<br>x binnendraad | M6 x M8  | 939020608              |
|   | M8 x M6  | 939020806              |
|   | M8 x M10 | 939020810              |
|   | M10 x M8 | 939021008              |
|   |          | Artikelgroep: 20.02.20 |




|   | Afmeting x lengte<br>in mm | Artikelnr.             |
|---|----------------------------|------------------------|
| <b>9486</b><br>Inslagpen met plug<br>- elektrolytisch<br>verzinkt | M8 x 100                   | 9486008100             |
|   |                            | Artikelgroep: 20.02.20 |



|  | Breedte x dikte in mm | Artikelnr.             |
|--|-----------------------|------------------------|
| <b>9387</b><br>Stalen montageband<br>- rollengte: 10 meter | 12 x 0,8              | 9387                   |
|  |                       | Artikelgroep: 20.02.20 |



|                                      | Afmeting | Artikelnr.             |
|--------------------------------------|----------|------------------------|
| <b>9487</b><br>Balkklem<br>- model C | M8 x 23  | 9487008                |
|                                      | M10 x 20 | 9487010                |
|                                      |          | Artikelgroep: 20.02.20 |





# 20.03 Kabelbinders

## Kabelbinders

### 1755

Kabelbinder  
- kleur: zwart  
- per 100 stuks



Lengte x dikte in mm      Artikelnr. per zak

|           |         |
|-----------|---------|
| 100 x 2,5 | 1755100 |
| 142 x 3,2 | 1755142 |
| 203 x 4,6 | 1755203 |
| 280 x 4,8 | 1755280 |
| 368 x 4,8 | 1755368 |
| 432 x 4,8 | 1755432 |
| 450 x 8,0 | 1755450 |

Artikelgroep: 20.03.05

# Productgroep 21

PE Drukleidingen > PVC Drukleidingen > PP Drukleidingen  
> Afstandbediende afsluiters > C-PVC Programma >  
Blue-system programma > Binnen- en buitenriolering  
> Kabelbescherming en telecom > Milieu programma  
> Tanks > Folie en geotextielen > Halffabrikaten >  
RVS Programma > Malleable programma > Sanitair  
en verwarming > Metalen appendages en fittingen >  
Slangen en koppelingen > Pompen, filters en kabel  
> Lijm, reiniger en toebehoren > Bevestigingsmaterialen >  
Machines en gereedschappen

>> Machines en gereedschappen

# Milder


— VEELZIJDIG IN LEIDINGSYSTEMEN —

# 21.01 Machines


## Lasmachines

- Alle onderstaande elektrolasmachines herkennen de fittingen van het Plasson elektrolasprogramma. Dit houdt in dat zodra de beide polen van de machines zijn aangesloten op de fitting, de machine automatisch de lastijd aangeeft. Kortom; **aansluiten fitting = herkenning lastijd**.
- De lasmachines zijn eenvoudig te bedienen vanwege het duidelijke display.
- Het gewicht van de lasmachines is rond 18-21 kilogram, met uitzondering van lichtgewicht lastrafo PF PolyCode artikel 3530 blz. 283.
- De machines zijn voorzien van een soepele kabel.
- Lasmachines zijn op aanvraag leverbaar met laskabel van 5 of 10 meter.
- Volgens normering CE en IP54.

|  | Koop/huur | Voltage | Artikelnr.   |
|--|-----------|---------|--|
| <b>3523</b><br><b>Lastrafo PF Monomatic</b><br>- eenvoudig in gebruik<br>- automatische herkenning Plasson lasfittingen<br>- laskabellengte: 5 meter | koop      | 230V    | 3523K  |
|  | huur      | 230V    | 3523   |
|  | koop      | 110V    | 3525K  |
|  | huur      | 110V    | 3525   |
|  |           |         | Artikelgroep koop: 21.01.05<br>Artikelgroep huur: 21.05.05 |



|  | Koop/huur | Artikelnr.   |
|--|-----------|--|
| <b>3527*</b><br><b>Lastrafo PF Polymatic Plus USB</b><br>- automatische herkenning Plasson lasfittingen<br>- geheugenregistratie van 1000 lasprocessen<br>- met barcodeleespen<br>- met USB aansluiting voor data overdracht<br>- laskabellengte: 5 meter<br>- voltage: 230V | koop      | 3527K  |
|  | huur      | 3527   |
|  |           | Artikelgroep koop: 21.01.05<br>Artikelgroep huur: 21.05.05 |



\* Deze lastrafo is optioneel leverbaar met GPS.

Artikelnr. 35275: lastrafo PF Polymatic Plus USB met barcode scanner.

Het Plasson elektrolasprogramma treft u in Groep 1 aan, vanaf blz. 41.  
Bent u in het bezit van een andere elektrolasmachine en wilt u het Plasson elektrolasprogramma proberen?  
Neem gerust contact op met onze verkoopmedewerkers en vraag naar de mogelijkheden.

## Lasmachines

|   | Koop/huur | Artikelnr.   |
|---|-----------|--|
| <b>3529</b><br><b>Lastrafo PF PolyControl Plus</b><br>- voor het lassen van grote fittingen<br>- door interne ventilator kortere afkoeltijd<br>- automatische herkenning Plasson lasfittingen<br>- geheugenregistratie van 1000 lasprocessen<br>- met barcodeleespen<br>- met USB aansluiting voor data overdracht<br>- laskabellengte: 10 meter<br>- voltage: 230V | koop      | 3529K  |
|   | huur      | 3529   |
|   |           | Artikelgroep koop: 21.01.05<br>Artikelgroep huur: 21.05.05 |



|  | Koop/huur | Artikelnr.   |
|--|-----------|--|
| <b>3530</b><br><b>Lastrafo PF PolyCode USB</b><br>- voor fittingen van 20 t/m 160mm<br>- automatische herkenning Plasson lasfittingen<br>- met barcodeleespen<br>- met USB aansluiting voor data overdracht<br>- lichtgewicht, 11 kg<br>- laskabellengte: 3 meter<br>- voltage: 230V | koop      | 3530K  |
|  | huur      | 3530   |
|  |           | Artikelgroep koop: 21.01.05<br>Artikelgroep huur: 21.05.05 |



|  | Artikelnr.                       |
|--|----------------------------------|
| <b>352306</b><br><b>PF Universele aansluitpolen</b><br>- passend voor 4,0 en 4,7 | 352306<br>Artikelgroep: 21.02.05 |



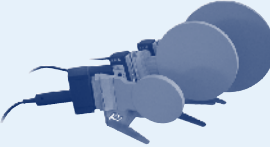
|   | Koop/huur | Artikelnr.   |
|---|-----------|--|
| <b>359911</b><br><b>Geberit elektro-lasmachine ESG 3 40/315</b><br>- voor lassen van Geberit afvoerhulpstukken 40mm t/m 315mm | koop      | 359911K  |
|   | huur      | 359911   |
|   |           | Artikelgroep koop: 21.01.05<br>Artikelgroep huur: 21.05.05 |



# 21.01 Machines


## Lasspiegels


|  | Koop/huur | Artikelnr.   |
|--|-----------|--|
| <b>359641</b><br>Lasspiegel Geberit KSS<br>- voor lassen tot 160mm | koop      | 359641K  |
|  | huur      | 359641   |
|  |           | Artikelgroep koop: 21.01.05<br>Artikelgroep huur: 21.05.10 |





Voor het leveren van spiegellas- en/of moflasmachines kunt u contact opnemen met onze afdeling verkoop.


## Buisschrappers

|  | Bereik in mm | Type       | Koop/huur | Artikelnr.   |
|--|--------------|------------|-----------|--|
| <b>3314</b><br>Buisschraper 125<br> | 20 t/m 125   | universeel | koop      | 3314K  |
|  | 20 t/m 125   | universeel | huur      | 3314   |
|  |              |            |           | Artikelgroep koop: 21.02.05<br>Artikelgroep huur: 21.05.15 |

|   | Bereik in mm | Type       | Koop/huur | Artikelnr.   |
|---|--------------|------------|-----------|--|
| <b>33142</b><br>Buisschraper 200<br> | 63 t/m 200   | universeel | koop      | 3314200K   |
|   | 63 t/m 200   | universeel | huur      | 3314200  |
|   |              |            |           | Artikelgroep koop: 21.02.05<br>Artikelgroep huur: 21.05.15 |

|   | Bereik in mm | Type       | Koop/huur | Artikelnr.   |
|---|--------------|------------|-----------|--|
| <b>33143</b><br>Buisschraper 315<br> | 90 t/m 315   | universeel | koop      | 3314315K   |
|   | 90 t/m 315   | universeel | huur      | 3314315  |
|   |              |            |           | Artikelgroep koop: 21.02.05<br>Artikelgroep huur: 21.05.15 |

|   | Bereik in mm | Type       | Koop/huur | Artikelnr.   |
|---|--------------|------------|-----------|--|
| <b>33144</b><br>Buisschraper 400<br> | 180 t/m 400  | universeel | koop      | 3314400K   |
|   | 180 t/m 400  | universeel | huur      | 3314400  |
|   |              |            |           | Artikelgroep koop: 21.02.05<br>Artikelgroep huur: 21.05.15 |


|   | Bereik in mm | Type       | Koop/huur | Artikelnr.   |
|---|--------------|------------|-----------|--|
| <b>33148</b><br>Buisschraper 800<br> | 250 t/m 800  | universeel | koop      | 3314800K   |
|   | 250 t/m 800  | universeel | huur      | 3314800  |
|   |              |            |           | Artikelgroep koop: 21.02.05<br>Artikelgroep huur: 21.05.15 |

|  | Bereik in mm | Type  | Artikelnr.                  |
|--|--------------|-------|-----------------------------|
| <b>331411</b><br>Reservemes voor buisschraper<br> | t/m 200      | blauw | 331411200                   |
|  | 315 t/m 400  | rood  | 331411400                   |
|  |              |       | Artikelgroep koop: 21.02.05 |

# 21.02 Lasprocedures en toebehoren

## Buisschraper en toebehoren

|                                      | Afmeting in mm | Artikelnr. |
|--------------------------------------|----------------|------------|
| <b>3315</b>                          | 20             | 3315020    |
| <b>Buisschraper voor boormachine</b> | 25             | 3315025    |
|                                      | 32             | 3315032    |
|                                      | 40             | 3315040    |
|                                      | 50             | 3315050    |
|                                      | 63             | 3315063    |
| Artikelgroep: 21.02.05               |                |            |



Artikelnr. 33151: reservemes voor buisschraper boormachine.

|                     | Afmeting | Artikelnr.             |
|---------------------|----------|------------------------|
| <b>364</b>          | 1 1/2"   | 364                    |
| <b>Handschraper</b> |          | Artikelgroep: 21.02.05 |



Artikelnr. 3641: Reservemes voor handschraper 364.

|  | Koop/huur | Artikelnr.                  |
|--|-----------|-----------------------------|
| <b>3320</b>  | koop      | 3320K                       |
|  | huur      | 3320                        |
| <b>Buisschraper 230V</b>                                     |           | Artikelgroep koop: 21.02.05 |
| - voor elektrolassaanboorzadel artikel 9380L, 9580L en 9590L |           | Artikelgroep huur: 21.05.15 |



|                               | Inhoud in ml | Artikelnr.             |
|-------------------------------|--------------|------------------------|
| <b>1711</b>                   | fles 1000    | 17111000               |
| <b>Griffon PE reiniger</b>    |              | Artikelgroep: 19.01.05 |
| - voor het reinigen van PE/PP |              |                        |



|                          | Inhoud             | Artikelnr.             |
|--------------------------|--------------------|------------------------|
| <b>17111</b>             | flacon à 100 stuks | 171110001              |
| <b>Reinigingsdoekjes</b> |                    | Artikelgroep: 19.01.05 |
| - geschikt voor PE/PP    |                    |                        |




|   | Artikelnr.             |
|---|------------------------|
| <b>17110</b>  | 171100003              |
| <b>Markeerstift</b>                                 | Artikelgroep: 21.03.05 |
| - wit   |                        |
| - voor het markeren van de insteekdiepte op PE buis |                        |

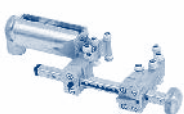


## Buissnijders


|                    | Bereik in mm | Artikelnr.             |
|--------------------|--------------|------------------------|
| <b>33180</b>       | 20 t/m 75    | 3318075                |
|                    | 50 t/m 140   | 3318140                |
|                    | 90 t/m 160   | 3318160                |
| <b>Buissnijder</b> |              | Artikelgroep: 21.02.05 |



|                        | Bereik in mm | Artikelnr.                  |
|------------------------|--------------|-----------------------------|
| <b>33281</b>           | 32 t/m 125   | 3328125K                    |
|                        |              | 3328125                     |
| <b>Buissnijder 125</b> |              | Artikelgroep koop: 21.02.05 |
|                        |              | Artikelgroep huur: 21.05.15 |



|                        | Bereik in mm | Artikelnr.                  |
|------------------------|--------------|-----------------------------|
| <b>33283</b>           | 90 t/m 315   | 3328315K                    |
|                        |              | 3328315                     |
| <b>Buissnijder 315</b> |              | Artikelgroep koop: 21.02.05 |
|                        |              | Artikelgroep huur: 21.05.15 |



## Buisklemmen sets


|                                 |   | Bereik in mm | Koop/huur | Artikelnr.   |
|---------------------------------|---|--------------|-----------|--|
| <b>33311</b><br>Buisklemmen set |  | 32 t/m 110   | koop      | 3331110K   |
|                                 |   | 32 t/m 110   | huur      | 3331110  |
|                                 |   |              |           | Artikelgroep koop: 21.02.05<br>Artikelgroep huur: 21.05.15 |

|                                 |   | Bereik in mm | Koop/huur | Artikelnr.   |
|---------------------------------|---|--------------|-----------|--|
| <b>33342</b><br>Buisklemmen set |  | 63 t/m 200   | koop      | 3334200K   |
|                                 |   | 63 t/m 200   | huur      | 3334200  |
|                                 |   |              |           | Artikelgroep koop: 21.02.05<br>Artikelgroep huur: 21.05.15 |

|                                 |  | Bereik in mm | Koop/huur | Artikelnr.   |
|---------------------------------|--|--------------|-----------|--|
| <b>33325</b><br>Buisklemmen set |  | 110 t/m 560  | koop      | 3332560K   |
|                                 |  | 110 t/m 560  | huur      | 3332560  |
|                                 |  |              |           | Artikelgroep koop: 21.02.05<br>Artikelgroep huur: 21.05.15 |

|                                 |   | Bereik in mm | Koop/huur | Artikelnr.   |
|---------------------------------|---|--------------|-----------|--|
| <b>33338</b><br>Buisklemmen set |  | 250 t/m 800  | koop      | 3333800K   |
|                                 |   | 250 t/m 800  | huur      | 3333800  |
|                                 |   |              |           | Artikelgroep koop: 21.02.05<br>Artikelgroep huur: 21.05.15 |

|   | Bereik in mm  | Bereik spie in mm | Koop/huur | Artikelnr.   |
|---|---|-------------------|-----------|--|
| <b>33170</b><br>Klemmen set   | 250 - 800   | 90 t/m 160        | koop      | 3317090160K  |
|   | 250 - 800   | 90 t/m 160        | huur      | 3317090160   |
| - voor elektrolas aanboorzadel artikel 9580L<br>- met drukttestbuisverwijderaar |   |                   |           | Artikelgroep koop: 21.02.05<br>Artikelgroep huur: 21.05.15 |
|   |  |                   |           |  |


|  | Bereik in mm  | Bereik spie in mm | Koop/huur | Artikelnr.   |
|--|---|-------------------|-----------|--|
| <b>33172</b><br>Klemmen set deelbaar   | 250 - 800   | 90 t/m 160        | koop      | 3317290160K  |
|  | 250 - 800   | 90 t/m 160        | huur      | 3317290160   |
| - voor elektrolas aanboorzadel met flensaftakking artikel 9590L<br>- met drukttestbuisverwijderaar |   |                   |           | Artikelgroep koop: 21.02.05<br>Artikelgroep huur: 21.05.15 |
|  |  |                   |           |  |



# 21.02 Lasprocedures en toebehoren

## Buisklemmen sets

|  | Koop/huur | Artikelnr.                  |
|--|-----------|-----------------------------|
| <b>3322</b><br><b>Boor- en klemgereedschap</b><br><b>riool afvoorzadel 160</b><br>- voor Plasson riool<br>afvoorzadel artikel 7580 | koop      | 3322K                       |
|  | huur      | 3322                        |
|  |           | Artikelgroep koop: 21.02.05 |
|  |           | Artikelgroep huur: 21.05.15 |



|  | Koop/huur | Artikelnr.                  |
|--|-----------|-----------------------------|
| <b>3323</b><br><b>Boor- en klemgereedschap riool</b><br><b>afvoorzadel 45°</b><br>- voor Plasson riool<br>afvoorzadel artikel 758A | koop      | 3323K                       |
|  | huur      | 3323                        |
|  |           | Artikelgroep koop: 21.02.05 |
|  |           | Artikelgroep huur: 21.05.15 |

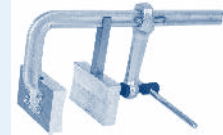


## Rondingsklemmen sets

|  | Bereik in mm | Koop/huur | Artikelnr. |                             |
|--|--------------|-----------|------------|-----------------------------|
| <b>33210</b><br><b>Rondingsklemmen set</b><br>- voor het opnieuw rond<br>maken van ovale PE buis | 32 t/m 40    | koop      | 3321040K   |                             |
|  | 32 t/m 40    | huur      | 3321040    |                             |
|  | 50 t/m 63    | koop      | 3321063K   |                             |
|  | 50 t/m 63    | huur      | 3321063    |                             |
|  |              |           |            | Artikelgroep koop: 21.02.05 |
|  |              |           |            | Artikelgroep huur: 21.05.15 |



|   | Bereik in mm | Koop/huur | Artikelnr. |                             |
|---|--------------|-----------|------------|-----------------------------|
| <b>33211</b><br><b>Rondingsklem</b><br>- voor het opnieuw rond<br>maken van ovale PE buis | 63 t/m 180   | koop      | 3321180K   |                             |
|   | 63 t/m 180   | huur      | 3321180    |                             |
|   | 250 t/m 400  | koop      | 3321400K   |                             |
|   | 250 t/m 400  | huur      | 3321400    |                             |
|   |              |           |            | Artikelgroep koop: 21.02.05 |
|   |              |           |            | Artikelgroep huur: 21.05.15 |



|  | Bereik in mm | Koop/huur | Artikelnr. |                             |
|--|--------------|-----------|------------|-----------------------------|
| <b>33258</b><br><b>Hydraulische</b><br><b>rondingsklemmen set</b><br>- voor grote diameter | 450 t/m 800  | koop      | 3325800K   |                             |
|  | 450 t/m 800  | huur      | 3325800    |                             |
|  |              |           |            | Artikelgroep koop: 21.02.05 |
|  |              |           |            | Artikelgroep huur: 21.05.15 |



## Gatzagen voor aanboorzadels

|  | Bereik in mm | Koop/huur | Artikelnr.                  |
|--|--------------|-----------|-----------------------------|
| <b>33190</b><br><b>Gatzaag set elektrolas aanboorzadel</b><br>- voor elektrolas aanboorzadel artikel 9580L en 9590L<br>- met druktestbuis-verwijderaar | 90 t/m 160   | koop      | 3319090160K                 |
|  | 90 t/m 160   | huur      | 3319090160                  |
|  |              |           | Artikelgroep koop: 21.02.05 |
|  |              |           | Artikelgroep huur: 21.05.15 |



|   | Afmeting | Koop/huur | Artikelnr.                  |
|---|----------|-----------|-----------------------------|
| <b>33192</b><br><b>Gatzaag voor aanboorzadel 2"</b><br>- voor elektrolas aanboorzadel artikel 9380L | 2"       | koop      | 3319200K                    |
|   | 2"       | huur      | 3319200                     |
|   |          |           | Artikelgroep koop: 21.02.05 |
|   |          |           | Artikelgroep huur: 21.05.15 |

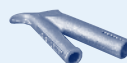


## Lasföhns

|   | Koop/huur | Artikelnr.                  |
|---|-----------|-----------------------------|
| <b>3835</b><br><b>Lasföhn</b><br>- voor het lassen van o.a. PVC, PE, PP | koop      | 3835K                       |
|   | huur      | 3835                        |
|   |           | Artikelgroep koop: 21.02.05 |
|   |           | Artikelgroep huur: 21.05.15 |



|   | Artikelnr. |
|---|------------|
| <b>38351</b><br><b>Lasmond voor lasföhn</b> | 38351      |
| Artikelgroep: 21.02.05                      |            |



Een elektrolasinstructie voor Plasson elektrolasfittingen is op te vragen via onze afdeling verkoop of te downloaden via [www.milder.nl](http://www.milder.nl).

### Instructie voor Plasson elektrolasfittingen

Belangrijke aandachtspunten met betrekking tot de richtlijnen van deze instructie.

1. Controleer het werkstuk voordat u de elektrode in de bus insteekt.
2. Controleer de afstand tot het werkstuk.
3. Controleer de afstand tot het werkstuk.
4. Controleer de afstand tot het werkstuk.
5. Controleer de afstand tot het werkstuk.
6. Controleer de afstand tot het werkstuk.
7. Controleer de afstand tot het werkstuk.
8. Controleer de afstand tot het werkstuk.
9. Controleer de afstand tot het werkstuk.
10. Controleer de afstand tot het werkstuk.
11. Controleer de afstand tot het werkstuk.
12. Controleer de afstand tot het werkstuk.

**Milder** - Welding in the Best Tradition - **PIPLASSON**

### Belangrijke aandachtspunten

Deze kaart bevat een belangrijke lasinstructie. Indien u vragen heeft over het elektrolasproces, neemt u den contact op met de medewerkers van onze verkoopafdeling in Binnveld of Rotterdam. Wij helpen u graag. Wij leveren zowel kunststof, polypropyleen als polyethyleen plus accessoires.

**Belangrijke aandachtspunten en insteken van de bus**  
 Wanneer u de elektrode in de bus insteekt, moet u de elektrode in de bus plaatsen. De elektrode moet in de bus zitten en niet uit de bus vallen. De elektrode moet in de bus zitten en niet uit de bus vallen. De elektrode moet in de bus zitten en niet uit de bus vallen.

**Buisklasse**  
 De busklasse is afhankelijk van de busklasse. De busklasse is afhankelijk van de busklasse. De busklasse is afhankelijk van de busklasse.

**Minneren van de insteekdiepte**  
 De insteekdiepte is afhankelijk van de busklasse. De insteekdiepte is afhankelijk van de busklasse. De insteekdiepte is afhankelijk van de busklasse.

**Gebruik van buisklemmen**  
 De buisklemmen worden gebruikt om de bus aan het werkstuk te bevestigen. De buisklemmen worden gebruikt om de bus aan het werkstuk te bevestigen.

**Niet schuren**  
 Het werkstuk moet niet worden geschuurd. Het werkstuk moet niet worden geschuurd. Het werkstuk moet niet worden geschuurd.

**Opslag van elektrolasfittingen**  
 De elektrolasfittingen moeten op een droge plaats worden opgeslagen. De elektrolasfittingen moeten op een droge plaats worden opgeslagen.

**Lasstokkokers**  
 De lasstokkokers worden gebruikt om de elektrode te beschermen. De lasstokkokers worden gebruikt om de elektrode te beschermen.

**Milder** - Welding in the Best Tradition - **PIPLASSON**

# 21.03 Gereedschappen

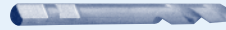
## Gatzagen

|                    | Afmeting in mm | Artikelnr. |
|--------------------|----------------|------------|
| <b>4916</b>        | 14             | 4916014    |
| <b>Gatzaag</b>     | 16             | 4916016    |
| - van hardmetaal   | 17             | 4916017    |
| - exclusief houder | 19             | 4916019    |
|                    | 21             | 4916021    |
|                    | 22             | 4916022    |
|                    | 24             | 4916024    |
|                    | 25             | 4916025    |
|                    | 27             | 4916027    |
|                    | 30             | 4916030    |
|                    | 32             | 4916032    |
|                    | 33             | 4916033    |
|                    | 35             | 4916035    |
|                    | 37             | 4916037    |
|                    | 38             | 4916038    |
|                    | 40             | 4916040    |
|                    | 41             | 4916041    |
|                    | 43             | 4916043    |
|                    | 44             | 4916044    |
|                    | 46             | 4916046    |
|                    | 48             | 4916048    |
|                    | 51             | 4916051    |
|                    | 52             | 4916052    |
|                    | 54             | 4916054    |
|                    | 57             | 4916057    |
|                    | 59             | 4916059    |
|                    | 60             | 4916060    |
|                    | 64             | 4916064    |
|                    | 65             | 4916065    |
|                    | 67             | 4916067    |
|                    | 70             | 4916070    |
|                    | 73             | 4916073    |
|                    | 76             | 4916076    |
|                    | 79             | 4916079    |
|                    | 83             | 4916083    |
|                    | 86             | 4916086    |
|                    | 89             | 4916089    |
|                    | 92             | 4916092    |
|                    | 95             | 4916095    |
|                    | 98             | 4916098    |
|                    | 102            | 4916102    |
|                    | 105            | 4916105    |
|                    | 108            | 4916108    |
|                    | 111            | 4916111    |
|                    | 114            | 4916114    |
|                    | 121            | 4916121    |
|                    | 127            | 4916127    |
|                    | 133            | 4916133    |
|                    | 140            | 4916140    |
|                    | 146            | 4916146    |
|                    | 152            | 4916152    |
|                    | 160            | 4916160    |

Artikelgroep: 21.03.05



|  | Voor gatzaag in mm | Artikelnr.             |
|--|--------------------|------------------------|
| <b>4919</b>                            | 14 t/m 30          | 4919                   |
| <b>Spiraalboor voor gatzaaghouders</b> |                    | Artikelgroep: 21.03.05 |
| - kort model                           |                    |                        |



|  | Voor gatzaag in mm | Artikelnr.             |
|--|--------------------|------------------------|
| <b>4918</b>                            | 32 t/m 152         | 4918                   |
| <b>Spiraalboor voor gatzaaghouders</b> |                    | Artikelgroep: 21.03.05 |
| - lang model                           |                    |                        |



|                    | Afmeting in mm | Keilinlaat in mm | Artikelnr.             |
|--------------------|----------------|------------------|------------------------|
| <b>4917</b>        | 133            | 125              | 4917133                |
| <b>Gatzaag</b>     | 168            | 160              | 4917168                |
| - van bi-metaal    |                |                  | Artikelgroep: 21.03.05 |
| - exclusief houder |                |                  |                        |



|                                       | Keilinlaat in mm | Artikelnr.             |
|---------------------------------------|------------------|------------------------|
| <b>93511</b>                          | 125              | 93511251               |
| <b>Montagesleutel voor keilinlaat</b> | 160              | 93511601               |
| - voor keilinlaat 9351                |                  | Artikelgroep: 21.03.05 |



|                       | Voor gatzaag in mm | Artikelnr.             |
|-----------------------|--------------------|------------------------|
| <b>4717</b>           | 14 t/m 30          | 47179161316            |
| <b>Gatzaaghouders</b> | 32 t/m 168         | 47171146               |
|                       |                    | Artikelgroep: 21.03.05 |




|                                   | Afmeting | Artikelnr. |
|-----------------------------------|----------|------------|
| <b>1771</b>                       | 1¼"      | 17710114   |
| <b>Foam Pig</b>                   | 1½"      | 17710112   |
| - voor het reinigen van leidingen | 2"       | 17710200   |
|                                   | 2½"      | 17710212   |
|                                   | 3"       | 17710300   |
|                                   | 4"       | 17710400   |
|                                   | 5"       | 17710500   |
|                                   | 6"       | 17710600   |
|                                   | 7"       | 17710700   |
|                                   | 8"       | 17710800   |
|                                   | 9"       | 17710900   |
|                                   | 10"      | 17711000   |
|                                   | 11"      | 17711100   |

Artikelgroep: 21.03.05




## Plasson gereedschappen

|                       | Afmeting in mm | Artikelnr.             |
|-----------------------|----------------|------------------------|
| <b>7990</b>           | 16 t/m 40      | 7990016040             |
| <b>Montagesleutel</b> | 40 t/m 75      | 7990040075             |
| - voor Plasson        | 63 t/m 125     | 7990063125             |
| klemfittingen         |                | Artikelgroep: 21.03.05 |




|                         | Afmeting in mm | Artikelnr.             |
|-------------------------|----------------|------------------------|
| <b>10990</b>            | 20 t/m 32      | 10990020032            |
| <b>Demontagesleutel</b> | 40 t/m 63      | 10990040063            |
| - voor Plasson Serie 1  |                | Artikelgroep: 21.03.05 |
| fittingen               |                |                        |




|                                       | Afmeting/bereik in mm | Artikelnr.             |
|---------------------------------------|-----------------------|------------------------|
| <b>7991</b>                           | 63 t/m 160            | 7991                   |
| <b>Plasson montage-sleutel tapper</b> |                       | Artikelgroep: 21.03.05 |
| - voor Plasson                        |                       |                        |
| aanboorzadel 6540                     |                       |                        |
| met tapper                            |                       |                        |



|                            | Artikelnr.             |
|----------------------------|------------------------|
| <b>9202</b>                | 9202000                |
| <b>Stalen Inbussleutel</b> | Artikelgroep: 21.03.05 |
| - voor Plasson elektrolas  |                        |
| aanboorzadel 9630          |                        |



|                         | Afmeting in mm | Artikelnr.             |
|-------------------------|----------------|------------------------|
| <b>7960</b>             | 20 t/m 63      | 7960020063             |
| <b>Afschuinapparaat</b> |                | Artikelgroep: 21.03.05 |
| - voor PE buis          |                |                        |



|  | Artikelnr.             |
|--|------------------------|
| <b>79601</b>                             | 79601                  |
| <b>Reserve mes voor afschuinapparaat</b> | Artikelgroep: 21.03.05 |



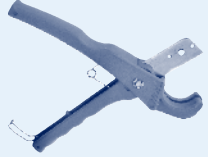
|                      | Artikelnr.             |
|----------------------|------------------------|
| <b>1746</b>          | 1746001                |
| <b>Buisontbramer</b> | Artikelgroep: 21.03.05 |




Artikelnr. 1746002: meshouder voor buisontbramer.

## Overige gereedschappen


|                                | Afmeting in mm | Artikelnr.             |
|--------------------------------|----------------|------------------------|
| <b>1747</b>                    | t/m 38         | 1747038                |
| <b>Kniptang</b>                | t/m 50         | 1747050                |
| - voor het knippen van PE buis | t/m 75         | 1747075                |
|                                |                | Artikelgroep: 21.03.05 |



|                                 | Afmeting in mm | Artikelnr.             |
|---------------------------------|----------------|------------------------|
| <b>1748</b>                     | t/m 38         | 1748038                |
| <b>Reservemes voor kniptang</b> | t/m 50         | 1748050                |
|                                 | max. 75        | 1748075                |
|                                 |                | Artikelgroep: 21.03.05 |



|                            | Afmeting in mm | Artikelnr.             |
|----------------------------|----------------|------------------------|
| <b>1749</b>                | t/m 63         | 1749063                |
| <b>Buisschaar</b>          |                | Artikelgroep: 21.03.05 |
| - met één hand te bedienen |                |                        |




|                      | Artikelnr.             |
|----------------------|------------------------|
| <b>1716</b>          | 1716                   |
| <b>Handzaag</b>      | Artikelgroep: 21.03.05 |
| - met geharde tanden |                        |



|                               | Afmeting | Artikelnr.             |
|-------------------------------|----------|------------------------|
| <b>1743</b>                   | 24"      | 1743024                |
| <b>Draadzaag</b>              | 72"      | 1743072                |
| - voor het zagen van PVC buis |          | Artikelgroep: 21.03.05 |



|   | Artikelnr.             |
|---|------------------------|
| <b>17110</b>  | 171100003              |
| <b>Markeerstift</b>                                 | Artikelgroep: 21.03.05 |
| - wit   |                        |
| - voor het markeren van de insteekdiepte op PE buis |                        |



## 21.03 Gereedschappen

### Overige gereedschappen

|  | Artikelnr.                        |
|--|-----------------------------------|
| <b>1780</b><br><b>Momentsleutel ½"</b><br>- met ½" aandrijfvierkant<br>- bereik van 10 Nm tot 210 Nm | 1780012<br>Artikelgroep: 21.03.05 |



|   | Afmeting in mm             | Artikelnr.   |
|---|----------------------------|--|
| <b>1781</b><br><b>Dop zeskant</b><br>- voor moment-<br>sleutel ½" | 13<br>16<br>20<br>24<br>27 | 1781013012<br>1781016012<br>1781020012<br>1781024012<br>1781027012 |

Artikelgroep: 21.03.05




## 21.04 Buisafsluiters


### Buisafsluiters

|  | Afmeting   | Bereik in mm | Max. druk in bar | Artikelnr. |
|--|------------|--------------|------------------|------------|
| <b>9415</b><br><b>Oppompbare buisafsluiter</b><br>- voorzien van 1,5m slang en ventiel<br>- geschikt voor moeilijk bereikbare plaatsen (ovale buizen en bochten)<br>- eenvoudig te reinigen en herbruikbaar<br>- bestand tegen bepaalde oliën, vetten, chemicaliën en heet water | DN50 (2")  | 48 - 72      | 1,70             | 9415050    |
|  | DN80 (3")  | 72 - 92      | 1,35             | 9415075    |
|  | DN100 (4") | 92 - 145     | 1,35             | 9415100    |
|  | DN150 (5") | 145 - 200    | 0,70             | 9415150    |
|  | DN200 (6") | 200 - 320    | 0,50             | 9415200    |

Artikelgroep: 21.04.05



|   | Artikelnr.                     |
|---|--------------------------------|
| <b>9417</b><br><b>Kunststof handpomp</b><br>- voor de oppompbare buisafsluiter 9415 | 9417<br>Artikelgroep: 21.03.05 |



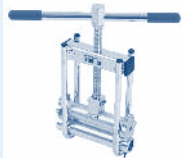
|   | Afmeting   | Bereik in mm | Artikelnr. |
|---|------------|--------------|------------|
| <b>9424</b><br><b>Kunststof afsluitstop</b> | DN20 (¾")  | 20 - 26      | 9424020    |
|   | DN25 (1")  | 25 - 32      | 9424025    |
|   | DN30 (1¼") | 34 - 43      | 9424030    |
|   | DN40 (1½") | 38 - 45      | 9424040    |
|   | DN50 (2")  | 49 - 62      | 9424050    |
|   | DN65 (2½") | 62 - 70      | 9424065    |
|   | DN80 (3")  | 74 - 86      | 9424080    |
|   | DN100 (4") | 93 - 108     | 9424100    |
|   | DN125 (5") | 124 - 137    | 9424125    |
| DN150 (6")                                  | 143 - 155  | 9424150      |            |

Artikelgroep: 21.04.05



|  | Bereik in mm | Type        | Artikelnr. |
|--|--------------|-------------|------------|
| <b>9428</b><br><b>PE Knelapparaat</b><br>- voor SDR11<br>- voor PE, HDPE en PP | 20 - 63      | Handbediend | 9428020063 |
|  | 75 - 200     | Hydraulisch | 9428075200 |

Artikelgroep: 21.04.05



# Alfabetische index

PE Drukleidingen > PVC Drukleidingen > PP Drukleidingen  
> Afstandbediende afsluiters > C-PVC Programma >  
Blue-system programma > Binnen- en buitenriolering  
> Kabelbescherming en telecom > Milieu programma  
> Tanks > Folie en geotextielen > Halffabrikaten >  
RVS Programma > Malleable programma > Sanitair  
en verwarming > Metalen appendages en fittingen >  
Slangen en koppelingen > Pompen, filters en kabel  
> Lijm, reiniger en toebehoren > Bevestigingsmaterialen >  
Machines en gereedschappen

**Milder**

— VEELZIJDIG IN LEIDINGSYSTEMEN —

# Alfabetische index

|  |                  |  |               |  |                  |
|--|------------------|--|---------------|--|------------------|
| <b>A</b>                                       |                  |  |               |  |                  |
| Aanboorzadels PP                               | 36               | Buis verzinkt                                | 208           | Elektrolas aanboorzadels Plasson                   | 46               |
| Aanboorzadels Plasson elektrolas               | 46               | Buis voor binnen- en buitenriolering         | 134           | Elektrolasfittings Plasson                         | 41               |
| Accessoires voor afstandbediende afsluiters    | 123              | Buis voor regenwaterafvoer                   | 135           | Elektrolasfittings voor hydranten Plasson          | 49               |
| Acrylaat buis                                  | 196              | Buisafsluiters                               | 292           | Elektrolasfittings voor riool-toepassingen Plasson | 48               |
| Afdekkingen kolken                             | 178              | Buisklemmen                                  | 276           |  |                  |
| Afdekkingen peilputten                         | 179              | Buisklemmen sets                             | 287           | <b>F</b>   |                  |
| Afdekkingen putten                             | 175              | Buisschaar                                   | 291           | Filter Arion                                       | 248              |
| Afdichtingen, pakkingen en Petro-band PSI      | 61, 91, 113, 242 | Buisschrapers                                | 285           | Filterbuis PVC en toebehoren                       | 76               |
| Afdichtingsmateriaal                           | 270              | Buissnijders                                 | 286           | Filters Arkal                                      | 265              |
| Afschuinapparaten                              | 34, 291          | Buitenriolering PVC afvoerbuis               | 134           | Fittingbuis PVC/PP                                 | 194              |
| Afsluiters Blue-system                         | 132              | Buitenriolering PVC manchet-hulpstukken SN4  | 144           | Fittingen Blue-system                              | 130              |
| Afsluiters C-PVC                               | 128              | Buitenriolering PVC manchet-hulpstukken SN8  | 148           | Fittingen C-PVC                                    | 126              |
| Afsluiters gietijzer                           | 226              | <b>C</b>                                     |               | Fittingen gietijzer                                | 231              |
| Afsluiters Plasson PE/PP                       | 67               | Compensatoren                                | 247           | Fittingen messing draad                            | 220              |
| Afsluiters Plasson PP lagedruk                 | 69               | Controleputten PE/PP/PVC                     | 154, 171, 177 | Fittingen messing knel                             | 218              |
| Afsluiters PP                                  | 70, 114          | C-PVC Afsluiters                             | 128           | Fittingen messing soldeer                          | 222              |
| Afsluiters voor PVC leidingen                  | 97               | C-PVC Buis                                   | 126           | Fittingen PP SDR11                                 | 108              |
| Afsluiters voor RVS leidingen                  | 206              | C-PVC Fittingen                              | 126           | Fittingen PP SDR17,6                               | 107              |
| Afstandbediende afsluiters                     | 118              | C-PVC Lijm, reiniger                         | 128, 268      | Fittingen trekvast verzinkt                        | 215              |
| Afvoerbuis PE Geberit                          | 160              | <b>D</b>                                     |               | Fittingen voor sanitair en verwarming              | 218              |
| Afvoerbuis PP                                  | 135              | Deelbare buis telecom                        | 172           | Fittingen verzinkt                                 | 208              |
| Afvoerbuis PVC voor binnen- en buitenriolering | 134              | Deelbare koppelingen telecom                 | 172           | Fittingen zwart                                    | 213              |
| Afvoergoten PE en toebehoren                   | 181              | Deelbare PE kabelbeschermingsbuis            | 168           | Flamco beugels                                     | 277              |
| Afvoerhulpstukken PE Geberit                   | 160              | Dekzeilen                                    | 190           | Flenzen RVS  | 204              |
| Afvoer PP manchet-hulpstukken                  | 142              | Dompelpompen                                 | 264           | Flenzen verzinkt                                   | 212              |
| Afvoer PVC lijm-hulpstukken binnenriolering    | 136              | Doorstroombeters                             | 101           | Flenzen voor PE leidingen                          | 59               |
| Afvoer PVC manchet-hulpstukken SN4             | 144              | Doorvoerbochten PVC                          | 140           | Flenzen voor PP leidingen                          | 111              |
| Afvoer PVC manchet-hulpstukken SN8             | 148              | Doorvoermanchetten PE Putten                 | 171           | Flenzen voor PVC leidingen                         | 89               |
| Aktief koolfilter                              | 174              | Draadfittingen messing                       | 220           | Flexkoppelingen                                    | 156              |
| Appendages metaal                              | 245              | Draadfittingen PP Plasson                    | 35            | Folie en geotextielen                              | 190              |
| Arion filter                                   | 248              | Draadfittingen PVC                           | 86            | Fucoli programma                                   | 226              |
| Arkal programma                                | 265              | Draadfittingen RVS                           | 201           | <b>G</b>   |                  |
| Armaturen messing voor sanitair en verwarming  | 224              | Draadstang RVS                               | 275           | Gatzagen   | 290              |
| Asco membraanafsluiters elektrisch bediend     | 122              | Draadstang verzinkt                          | 274           | Gatzagen aanboorzadels                             | 289              |
|  |                  | Drainagebuis PE                              | 157           | Gatzagen PE Putten                                 | 176              |
| <b>B</b>                                       |                  | Drainage hulpstukken                         | 158           | Geberit PE Afvoerbuis                              | 160              |
| Balkeerleppen gietijzer                        | 228              | Drainageputten PVC                           | 158           | Geberit PE Afvoerhulpstukken                       | 160              |
| Beugels Flamco                                 | 277              | Drukbus PE                                   | 26            | Gegroefde PE buis                                  | 168              |
| Beugels kunststof                              | 276              | Drukbus PP                                   | 106           | Geotextielen en folie                              | 190              |
| Beugels staal/verzinkt                         | 277              | Drukbus PVC                                  | 74            | Gereedschappen overige                             | 291              |
| Beugels toebehoren                             | 279              | Drukbus ZPE                                  | 27            | Gereedschappen Plasson                             | 34, 291          |
| Beugels voor PE afvoersysteem                  | 165              | Drukfittingen PE SDR11 kort model            | 56            | Gereedschappen Plasson Serie 1                     | 40               |
| Beulco messing koppelingen                     | 66               | Drukfittingen PE SDR11 met lange spie-einden | 54            | Gietijzeren afsluiters                             | 226              |
| Bevestigingsmaterialen                         | 274              | Drukfittingen PE SDR11 r=1,5d                | 58            | Gietijzeren afsluiters toebehoren                  | 228              |
| Binnenriolering PP manchet-hulpstukken         | 142              | Drukfittingen PE SDR17 kort model            | 52            | Gietijzeren balkeerleppen                          | 228              |
| Binnenriolering PVC afvoerbuis                 | 134              | Drukfittingen PE SDR17 met lange spie-einden | 50            | Gietijzeren brandkranen                            | 241              |
| Binnenriolering PVC afvoer lijm-hulpstukken    | 136              | Drukfittingen PE SDR17 r=1,5d                | 53            | Gietijzeren dubbeldisc keerklep                    | 248              |
| Blue-system afsluiters                         | 132              | Drukfittingen PP SDR11                       | 108           | Gietijzeren fittingen                              | 231              |
| Blue-system buis                               | 130              | Drukfittingen PP SDR11 voor moflas           | 109           | Gietijzeren kolkafdekkingen                        | 178              |
| Blue-system fittingen                          | 130              | Drukfittingen PP SDR17,6                     | 107           | Gietijzeren kolkafdekkingen                        | 179              |
| Blue-system lijm, reiniger                     | 132, 269         | Drukfittingen PVC met draadverbinding        | 86            | Gietijzeren peilputafdekkingen                     | 175              |
| Bouten RVS                                     | 275              | Drukfittingen PVC met lijm-/draadverbinding  | 81            | Gietijzeren putafdekkingen                         | 175              |
| Bouten verzinkt                                | 274              | Drukfittingen PVC met lijmverbinding         | 77            | Gietijzeren straat- en trottoirkoppen              | 178              |
| Bovengrondse opslagtanks                       | 186              | Drukfittingen PVC met manchet-verbinding     | 96            | Gietijzeren viandekleppen                          | 229              |
| Bronzen/messing schuifafsluiters               | 246              | Dubbeldisc keerklep                          | 248           | Griffon lijm en reiniger                           | 155, 268         |
| Buis acrylaat                                  | 196              | <b>E</b>                                     |               | Grondkabel   | 266              |
| Buis Blue-system                               | 130              | Elektrolasmachines                           | 282           |  |                  |
| Buis C-PVC                                     | 126              | Elektrisch bediende kogelkranen              | 120           | <b>H</b>   |                  |
| Buis halffabrikaten                            | 194              | Elektrisch bediende membraanafsluiters       | 121           | Halfabrikaten buis                                 | 194              |
| Buis koper en Wicu                             | 218              | Elektrisch bediende membraanafsluiters ASCO  | 122           | Halfschalen  | 165              |
| Buis PE 100                                    | 26               | Elektrisch bediende viandekleppen            | 120           | Handholes  | 171              |
| Buis PE 100 voor gas                           | 26               | Elektrobus                                   | 169           | Handschrappers                                     | 286              |
| Buis PVC transparant                           | 75               |  |               | Hawle steekfittingen                               | 64               |
| Buis RVS                                       | 200              |  |               | HDPE Buis  | 26               |
|  |                  |  |               | HDPE Buis voor gas                                 | 26               |
|  |                  |  |               | Holstaf PVC  | 194              |
|  |                  |  |               | Hulpstukken PP binnenriolering                     | 142              |
|  |                  |  |               | Hulpstukken PVC binnenriolering                    | 136              |
|  |                  |  |               | Hulpstukken PVC buitenriolering SN4                | 144              |
|  |                  |  |               | Hulpstukken PVC buitenriolering SN8                | 148              |
|  |                  |  |               | Hulpstukken PVC HV gemaakt uit buis                | 94               |
|  |                  |  |               | Hulpstukken PVC regenwaterafvoer                   | 150              |
|  |                  |  |               | Hulpstukken drainage                               | 158              |
|  |                  |  |               | Hydranten  | 182              |
|  |                  |  |               | <b>I</b>   |                  |
|  |                  |  |               | Industriebeugels                                   | 278              |
|  |                  |  |               | Industriebuis PVC                                  | 74               |
|  |                  |  |               | Infiltratie units                                  | 180              |
|  |                  |  |               | Injectoren Mazzei                                  | 265              |
|  |                  |  |               | Inspectie- en pompputten PE                        | 174              |
|  |                  |  |               | <b>K</b>   |                  |
|  |                  |  |               | Kabel  | 266              |
|  |                  |  |               | Kabelafdekband/kabellabels                         | 170              |
|  |                  |  |               | Kabelbescherming PE                                | 168              |
|  |                  |  |               | Kabelbescherming PVC                               | 169              |
|  |                  |  |               | Kabelbescherming toebehoren                        | 170              |
|  |                  |  |               | Kabelbinders                                       | 280              |
|  |                  |  |               | Kabeltrekput PE                                    | 171              |
|  |                  |  |               | Kebu Petro-band, reparatieband en kneedmassa       | 63, 93, 244, 271 |
|  |                  |  |               | Keerklep dubbeldisc                                | 248              |
|  |                  |  |               | Keilnlaet  | 147              |
|  |                  |  |               | Klemfittingen Plasson                              | 27               |
|  |                  |  |               | Knelfittingen messing                              | 218              |
|  |                  |  |               | Knevelnlaet  | 147              |
|  |                  |  |               | Kniptang   | 291              |
|  |                  |  |               | Kogelkranen elektrisch bediend                     | 120              |
|  |                  |  |               | Kogelkranen messing verchromd                      | 245              |
|  |                  |  |               | Kogelkranen pneumatisch bediend                    | 118              |
|  |                  |  |               | Kogelkranen PVC                                    | 97               |
|  |                  |  |               | Kogelkranen RVS                                    | 206              |
|  |                  |  |               | Kolkafdekkingen                                    | 178              |
|  |                  |  |               | Kolken PE  | 177              |
|  |                  |  |               | Kolken PVC   | 153              |
|  |                  |  |               | Koolfilter   | 174              |
|  |                  |  |               | Kopere- en Wicu buis                               | 218              |
|  |                  |  |               | Koppelingen Beulco messing                         | 66               |
|  |                  |  |               | Koppelingen Type Camlock                           | 261              |
|  |                  |  |               | Koppelingen messing Type Geka                      | 257              |
|  |                  |  |               | Koppelingen Storz lichtmetaal                      | 260              |
|  |                  |  |               | Kunststof beugels                                  | 276              |
|  |                  |  |               | Kunststof platen PE/PP/PVC                         | 195              |
|  |                  |  |               | Kwasten  | 103, 269         |
|  |                  |  |               | <b>L</b>   |                  |
|  |                  |  |               | Lagedruk afsluiters PP Plasson                     | 69               |
|  |                  |  |               | Lasbochten staal                                   | 215              |
|  |                  |  |               | Lasdraad PE  | 195              |
|  |                  |  |               | Lasfittingen RVS                                   | 205              |
|  |                  |  |               | Lasföhns   | 289              |
|  |                  |  |               | Lasmachines  | 282              |
|  |                  |  |               | Lasspiegels  | 284              |
|  |                  |  |               | Lijm   | 268              |
|  |                  |  |               | Link-Seal afsluitschakel PSI                       | 62, 92, 243      |
|  |                  |  |               | Luchtleidingen en -fittingen                       | 124              |
|  |                  |  |               | <b>M</b>   |                  |
|  |                  |  |               | Machines   | 282              |
|  |                  |  |               | Malleable fittingen                                | 208              |
|  |                  |  |               | Malleable pijpnippels                              | 213              |
|  |                  |  |               | Mano- en vacuümmeters met kastdiameter 63mm        | 249              |
|  |                  |  |               | Mano- en vacuümmeters met kastdiameter 100mm       | 250              |
|  |                  |  |               | Markeerstift                                       | 40, 286, 291     |
|  |                  |  |               | Mazzei injectoren                                  | 265              |
|  |                  |  |               | Membraanafsluiters elektrisch bediend              | 121              |
|  |                  |  |               | Membraanafsluiters pneumatisch bediend             | 119              |
|  |                  |  |               | Messing armaturen voor sanitair en verwarming      | 224              |

|  |                   |   |                   |  |               |  |          |
|--|-------------------|---|-------------------|--|---------------|--|----------|
| Messing/bronzen schuifafsluiters             | 246               | Petro-band, pakkingen                             |                   | PVC Holstaf/volstaf                          | 194           | Terugslagkleppen messing                     | 247      |
| Messing draadfittingen                       | 220               | en afdichtingen PSI                               | 61, 91, 113, 242  | PVC Hulpstukken binnenriolering              | 136           | Terugslagkleppen PVC                         | 99       |
| Messing drukreducerventiel                   | 248               | PE Versterkte buis                                | 26                | PVC Hulpstukken buitenriolering              | 144           | Terugslagkleppen RVS                         | 206      |
| Messing kneffittingen                        | 218               | Pijpnippels verzinkt en zwart                     | 213               | PVC Hulpstukken regenwaterafvoer             | 150           | Transparante buis PVC                        | 75       |
| Messing koppelingen Beulco                   | 66                | Plasson elektroas aanboorzadels                   | 46                | PVC HV Hulpstukken gemaakt uit buis          | 94            | Tricoflex slang                              | 254      |
| Messing koppelingen type Geka                | 257               | Plasson elektroasfittingen                        | 41                | PVC HV Wanddoorvoer gemaakt uit buis         | 95            | Trottoirkoppen gietijzer                     | 178      |
| Messing slangtules                           | 258               | Plasson elektroasfittingen voor hydranten         | 49                | PVC Industriebuis                            | 74            | Trottoir-/straatkolken PE                    | 153, 177 |
| Messing soldeerfittingen                     | 222               | Plasson elektroasfittingen voor riooltoepassingen | 48                | PVC Kabelbescherming                         | 169           | Trottoir-/straatkolken PVC                   | 153      |
| Messing terugslagkleppen                     | 247               | Plasson gereedschappen                            | 34, 291           | PVC Kogelkranen                              | 97            | <b>V</b>                                     |          |
| Messing veiligheidstoestel                   | 248               | Plasson klemfittingen                             | 27                | PVC Kolken onderbak                          | 153           | Vacuüm- en manometers met kastdiameter 63mm  | 249      |
| Messing verchroomde kogelkranen              | 245               | Plasson klemfittingen onderdelen                  | 33                | PVC Lijm, reiniger                           | 102, 155, 268 | Vacuüm- en manometers met kastdiameter 100mm | 250      |
| Messing vuilvanger                           | 248               | Plasson montagesleutels                           | 34, 36, 40, 291   | PVC Ontluchtingskappen                       | 152           | Verwarming en sanitair                       | 218      |
| Metalen appendages                           | 245               | Plasson PE/PP afsluiters                          | 67                | PVC/PP/PE Controleputten                     | 154, 177      | Verzinkte beugels                            | 277      |
| Meterkastvloerplaat                          | 139               | Plasson PP aanboorzadels                          | 36                | PVC Regenwaterafvoerbuis                     | 135           | Verzinkte bouten, moeren en sluitringen      | 274      |
| Milieu kolk PE                               | 177               | Plasson PP draadfittingen                         | 35                | PVC Regenwaterafvoer hulpstukken             | 150           | Verzinkte buis                               | 208      |
| Milieu programma                             | 174               | Plasson PP lagedruk afsluiters                    | 69                | PVC Straat- en trottoirkolken                | 153           | Verzinkte draadstang                         | 274      |
| Moeren RVS                                   | 205, 275          | Plasson PP draadfittingen                         | 35                | PVC Terugslagkleppen                         | 99            | Verzinkte fittingen                          | 208      |
| Moeren verzinkt                              | 274               | Plasson PP lagedruk afsluiters                    | 69                | PVC Transparante buis                        | 75            | Verzinkte pijpnippels                        | 213      |
| Mofasfittingen PP                            | 110               | Plasson Serie 1                                   | 37                | PVC Volstaf/holstaf                          | 194           | Verzinkte trekvaste fittingen                | 215      |
| Momentsleutel                                | 292               | Plasson Serie 1 gereedschappen en toebehoren      | 40                | PVC Vlinderkleppen                           | 100           | Vlinderkleppen elektrisch bediend            | 120      |
| Montageband staal                            | 279               | Platen kunststof PE/PVC/PP                        | 195               | PVC Vuilvangers                              | 98            | Vlinderkleppen gietijzer                     | 229      |
| Montagesleutels Plasson                      | 34, 36, 40, 291   | Pneumatisch bediende kogelkranen                  | 118               | <b>R</b>                                     |               | Vlinderkleppen pneumatisch bediend           | 118      |
| <b>O</b>                                     |                   | Pneumatisch bediende membraan-afsluiters          | 119               | Regenwaterafvoerbuis PVC                     | 135           | Vlinderkleppen PVC                           | 100      |
| Onderbakken PVC kolken                       | 153               | Pneumatisch bediende vlinderkleppen               | 118               | Regenwaterafvoer hulpstukken PVC             | 150           | Volstaf PVC                                  | 194      |
| Onderdelen Plasson klemfittingen             | 33                | Pompen  | 264               | Reiniger                                     | 269           | Vuilvangers PVC                              | 98       |
| Onderdelen PVC fittingen                     | 88                | Pomp- en inspectieputten PE                       | 174               | Richdel membraanafsluiters                   | 121           | <b>W</b>                                     |          |
| Ondergrondse tanks                           | 187               | PP Aanboorzadels                                  | 36                | Rondingsklemmen sets                         | 288           | Waarschuwingsslint                           | 170      |
| Ontluchtingskappen PVC                       | 152               | PP Afsluiters                                     | 70, 114           | RVS Afsluiters                               | 206           | Wanddoorvoer PVC HV gemaakt uit buis         | 95       |
| Ophangband kunststof                         | 279               | PP Afsluiters Plasson lagedruk                    | 69                | RVS Bouten, moeren en sluitringen            | 275           | Wandkabel                                    | 266      |
| Opslagtanks bovengronds                      | 186               | PP Afvoerbuis                                     | 135               | RVS Buis                                     | 201           | Watermeters                                  | 251      |
| Opslagtanks ondergronds                      | 187               | PP Afvoer manchethulpstukken                      | 142               | RVS Draadfittingen                           | 201           | Watermeters toebehoren                       | 252      |
| <b>P</b>                                     |                   | PP Controleput                                    | 154, 177          | RVS Draadstang                               | 275           | Wicu buis                                    | 218      |
| Pakkingen, afdichtingen                      |                   | PP Draadfittingen Plasson                         | 35                | RVS Flenzen                                  | 204           | <b>Z</b>                                     |          |
| en Petro-band PSI                            | 61, 91, 113, 242  | PP Drukbus  | 106               | RVS Kogelkranen                              | 206           | ZPE Buis                                     | 27       |
| PE 100 drukkbus                              | 26                | PP Fittingbuis                                    | 194               | RVS Sluitringen                              | 205           | Zwaarverkeersdeksels                         | 175      |
| PE 100 drukkbus voor gas                     | 26                | PP Drukfittingen SDR11                            | 108               | RVS Lasfittingen                             | 205           | Zware industriebeugels                       | 278      |
| PE Afvoergoten en toebehoren                 | 181               | PP Drukfittingen SDR11 voor moflas                | 109               | RVS Schuifafsluiters                         | 206           | Zwarte fittingen                             | 213      |
| PE Afvoerbuis Geberit                        | 160               | PP Drukfittingen SDR17,6                          | 107               | RVS Terugslagkleppen                         | 206           | Zwarte pijpnippels                           | 213      |
| PE Afvoerhulpstukken Geberit                 | 160               | PP Flenzen voor PE leidingen                      | 59                | <b>S</b>                                     |               |  |          |
| PE Buis gegroefd                             | 168               | PP Flenzen voor PP leidingen                      | 111               | Sanitair en verwarming                       | 218           |  |          |
| PE Buis voor gas                             | 26                | PP Flenzen voor PVC leidingen                     | 90                | Schuifafsluiters brons/messing               | 246           |  |          |
| PE Buis ZPE                                  | 27                | PP/PE Reiniger                                    | 72, 116, 269, 286 | Schuifafsluiters RVS                         | 206           |  |          |
| PE Controleput                               | 171, 177          | PP/PE/PVC Controleputten                          | 154, 177          | Serie 1 Plasson                              | 37            |  |          |
| PE Drainagebuis                              | 157               | PSI Link-Seal afsluitschakel                      | 62, 92, 243       | Serie 1 Plasson gereedschappen en toebehoren | 40            |  |          |
| PE Elektroasfittingen Plasson                | 41                | PSI Pakkingen, afdichtingen                       |                   | Slangen                                      | 254           |  |          |
| PE Drukfittingen SDR11 kort model            | 56                | en Petro-band                                     | 61, 91, 113, 242  | Slangklemmen                                 | 256           |  |          |
| PE Drukfittingen SDR11 met lange spie-einden | 54                | Putafdekkingen                                    | 175               | Slangtules messing                           | 258           |  |          |
| PE Drukfittingen SDR11 r=1,5d                | 58                | Putten PVC drainage                               | 158               | Sluitringen RVS                              | 275           |  |          |
| PE Drukfittingen SDR17 kort model            | 52                | Puttenstaat PE inspectieputten                    | 183               | Sluitringen verzinkt                         | 274           |  |          |
| PE Drukfittingen SDR17 met lange spie-einden | 50                | Puttenstaat PVC/PE drainageputten                 | 159               | Soldeerfittingen messing                     | 222           |  |          |
| PE Drukfittingen SDR17 r=1,5d                | 53                | PVC Afvoerbuis voor binnen- en buitenriolering    | 134               | Spie-laseind PE voor afsluiters              | 70, 114       |  |          |
| PE Geberit afvoersysteem                     | 160               | PVC Afvoer lijmhulpstukken binnenriolering        | 136               | Sproeiappendages                             | 259           |  |          |
| Peilputafdekkingen                           | 179               | PVC Afvoer manchethulpstukken SN4                 | 144               | Stalen beugels                               | 277           |  |          |
| Peilputten                                   | 179               | PVC Afvoer manchethulpstukken SN8                 | 148               | Stalen lasbochten                            | 215           |  |          |
| PE Inspectie- en pompputten                  | 174               | PVC Beugels/zadels                                | 276               | Steekfittingen Hawle                         | 64            |  |          |
| PE Inspectie- en pompputten toebehoren       | 176               | PVC Controleput                                   | 154               | Stelranden beton                             | 175           |  |          |
| PE Kabelbescherming                          | 168               | PVC Doorvoerbochten                               | 140               | Storz koppelingen lichtmetaal                | 260           |  |          |
| PE Kabeltrekput                              | 171               | PVC Drainageputten                                | 158               | Straatkoppen gietijzer                       | 178           |  |          |
| PE Kolken                                    | 177               | PVC Drukbus                                       | 74                | Straatpotten en toebehoren                   | 230           |  |          |
| PE Peilputten                                | 179               | PVC Drukfittingen met draadverbinding             | 86                | Straat-/trottoirkolken PE                    | 177           |  |          |
| PE/PP Afsluiters Plasson                     | 67                | PVC Drukfittingen met lijm-/draadverbinding       | 81                | Straat-/trottoirkolken PVC                   | 153           |  |          |
| PE/PP/PVC Controleputten                     | 154, 177          | PVC Drukfittingen met lijmverbinding              | 77                | <b>T</b>                                     |               |  |          |
| PE/PP/PVC Platen                             | 195               | PVC Drukfittingen met manchetterverbinding        | 96                | Tangit lijm en reiniger                      | 102, 268      |  |          |
| PE/PP Reiniger                               | 72, 116, 269, 286 | PVC Drukfittingen met manchetterverbinding        | 96                | Tanks bovengronds en ondergronds             | 186           |  |          |
| PE Spie-laseind voor afsluiters              | 70, 114           | PVC Filterbuis en toebehoren                      | 76                | Tanks toebehoren                             | 188           |  |          |
| PE Tanks bovengronds                         | 186               | PVC Fittingbuis                                   | 194               | Tape en toebehoren                           | 271           |  |          |
| PE Tanks ondergronds                         | 187               | PVC Fittingen onderdelen                          | 88                | Tegelpadkolk-/kop                            | 154           |  |          |
|  |                   | PVC Flenzen voor PVC leidingen                    | 89                | Telecom                                      | 171           |  |          |
|  |                   |   |                   | Telecom toebehoren                           | 172           |  |          |



# Algemene verkoop- en leveringsvoorwaarden Milder Holland bv

## Artikel 1: algemene bepalingen

**1.1** In deze algemene voorwaarden gelden de volgende definities: Milder Holland bv: De besloten vennootschap met beperkte aansprakelijkheid Milder Holland bv, gevestigd en kantoorhoudende te Bemmel aan de Nijverheidstraat 28.

De afnemer: De afnemer die met Milder Holland bv een overeenkomst (wil) sluit(en) betreffende door Milder Holland bv te leverende zaken en/of werkzaamheden en/of diensten.

**1.2** Deze algemene voorwaarden zijn van toepassing op alle overeenkomsten tussen Milder Holland bv en de afnemer. Deze voorwaarden zijn voorts waar mogelijk van toepassing op de verhouding tussen Milder Holland bv en de afnemer gedurende de periode dat Milder Holland bv en de afnemer met elkaar in onderhandeling zijn over het al dan niet sluiten van een overeenkomst.

**1.3** Andere dan deze algemene voorwaarden, met name die voorwaarden waarvan de afnemer zich bedient, zijn voor Milder Holland bv niet verbindend, tenzij deze door haar schriftelijk aanvaard zijn.

**1.4** Mocht een bepaling uit deze algemene voorwaarden nietig zijn, dan laat dit de geldigheid van de overige bepalingen onverlet.

**1.5** Aanvullende of afwijkende bedingen of voorwaarden zijn alleen van kracht indien Milder Holland bv deze schriftelijk heeft aanvaard; deze afwijkingen gelden alleen voor de overeenkomst waarbij zij gemaakt zijn.

**1.6** Alle aanbestedingen zijn vrijblijvend, tenzij anders is overeengekomen. Milder Holland bv is pas gebonden, nadat zij de opdracht van de afnemer binnen redelijke termijn schriftelijk heeft aanvaard, dan wel nadat zij op een redelijke termijn met de uitvoering van de opdracht is begonnen. Na het sluiten van de overeenkomst worden alle tevoren gemaakte afspraken die niet schriftelijk zijn aanvaard geacht te zijn vervallen. Nadere overeenkomsten zijn slechts bindend indien zij schriftelijk door Milder Holland bv zijn bevestigd.

**1.7** Milder Holland bv behoudt alle rechten op de gegevens, voorkomende in haar aanbiedingen en de daarbij gevoegde modellen, monstertekeningen en gebruiksvoorschriften, e.d. Tekeningen, beschrijvingen, technische gegevens, afbeeldingen en overige bijzonderheden betreffende zaken (producten) en/of productieprocessen van Milder Holland bv zijn van vertrouwelijke aard en mogen niet zonder schriftelijke toestemming van Milder Holland bv aan derden ter beschikking worden gesteld of zelfs ter inzage worden verstrekt.

**1.8** Technische gegevens, maten, gewichten, prijzen e.d. in prijscatalogi, offertes en andere documenten zijn niet bindend voor Milder Holland bv en zij behoudt zich de gebruikelijke spelruimte voor. Geringe afwijkingen geven de afnemer niet het recht de overeenkomst te ontbinden, zijn betalingsverplichting op te schorten of schadevergoeding te vorderen.

**1.9** Wijzigingen in de oorspronkelijke opdracht van welke aard ook, moeten schriftelijk door de afnemer aan Milder Holland bv worden doorgegeven. Indien dat hogere kosten veroorzaakt dan voorzien in de prijsopgave, dan is Milder Holland bv gerechtigd deze extra kosten in rekening te brengen.

## Artikel 2: prijzen

**2.1** Alle prijsopgaven en prijzen die in rekening gebracht worden zijn af fabriek, werkplaats c.q. magazijn Milder Holland bv exclusief BTW, en eventuele andere op de overeenkomst vallende kosten, zoals heffingen, invoerrechten en dergelijke, in Euro's, tenzij uitdrukkelijk anders is overeengekomen.

**2.2** De prijzen zijn gebaseerd op het ten tijde van het afsluiten van de overeenkomst geldende kostenfactoren, zoals materialen, lonen, in- en uitvoerrechten, belastingen, vracht, assurantie, en verdere prijsbepalende factoren.

**2.3** Indien zich na het sluiten van de overeenkomst wijzigingen voordoen in de voor Milder Holland bv geldende kostprijs, bijvoorbeeld door wijziging in energie-, loon-, transport- of productiekosten, heeft Milder Holland bv het recht deze wijzigingen aan de afnemer door te berekenen.

Alleen in het geval dat Milder Holland bv dit binnen drie maanden na het sluiten van de overeenkomst doet, heeft de afnemer het recht de overeenkomst te ontbinden tegen een redelijke vergoeding voor door Milder Holland bv geleden verlies en/of gederfde winst.

**2.4** Indien betaling is overeengekomen in buitenlandse valuta, is Milder Holland bv gerechtigd de prijzen dienovereenkomstig te wijzigen, indien na het sluiten van de overeenkomst de koersen zijn gewijzigd.

## Artikel 3: levering/transport

**3.1** Alle leveringen door Milder Holland bv geschieden af fabriek, werkplaats c.q. magazijn Milder Holland bv, tenzij Milder Holland bv het transport naar de plaats van aflevering verzorgt. Voor levering buiten Nederland gelden de zaken als afgeleverd bij aankomst aan de (Nederlandse) grens, haven dan wel luchthaven. Vanaf het moment van levering zijn de zaken voor risico van de afnemer.

**3.2** Indien Milder Holland bv het transport naar de plaats van aflevering verzorgt geschiedt het transport voor leveringen van € 500,- en meer (excl. BTW) binnen Nederland kosteloos. Bij leveringen beneden dit bedrag worden transportkosten in rekening gebracht. Bij leveringen beneden € 50,- wordt bovendien een orderkostentoeslag in rekening gebracht.

**3.3** Opgegeven levertijden zullen nimmer zijn te beschouwen als fatale termijnen, tenzij uitdrukkelijk anders is overeengekomen.

**3.4** Milder Holland bv is, nadat zij in gebreke gesteld is, gedurende de in de ingebrekestelling gestelde termijn voor de nakoming niet aansprakelijk voor de gevolgen van overschrijding van de leveringstermijn.

**3.5** De afnemer ontleent aan de overschrijding van de oorspronkelijke termijn voor nakoming niet het recht de overeenkomst te ontbinden, schadevergoeding te vorderen dan wel zijn verplichtingen uit de overeenkomst op te schorten.

## Artikel 4: garanties en reclames

**4.1** Milder Holland bv garandeert de deugdelijkheid en kwaliteit van de door haar geleverde zaken, gebruikte materialen, vervangen onderdelen en/of de behoorlijke uitvoering van haar werkzaamheden of diensten gedurende een termijn van 12 maanden, na levering dan wel na verrichting van de werkzaamheden of diensten, zij het met inachtneming van de hierna gestelde beperkingen.

**4.2** Onder de garantie vallen niet de gevolgen van normale slijtage (zoals onder meer de vervanging van batterijen, elektroden, rubber en glazen onderdelen) of onkundig dan wel onjuist gebruik.

**4.3** Indien de geleverde zaken door Milder Holland bv zijn betrokken van een derde (leverancier) en zonder be- of verwerking door Milder Holland bv aan de afnemer zijn doorgeleverd, is de garantie zowel in duur als in omvang beperkt tot de garantie die Milder Holland bv van deze derde ontvangt.

**4.4** De garantie voor geleverde zaken en gebruikte materialen is beperkt tot materiaal- en constructiefouten, in welk geval Milder Holland bv alleen verplicht is tot reparatie dan wel vervanging van de defecte onderdelen, en wel onder de navolgende voorwaarden: indien werkzaamheden buiten de Milder Holland bv-werkplaats dienen plaats te vinden worden voorrijkosten en arbeidsloon in rekening gebracht, zij het dat voorrijkosten niet verschuldigd zijn indien de werkzaamheden moeten worden verricht aan zaken die door Milder Holland bv zijn geïnstalleerd; indien, naar het oordeel van Milder Holland bv, de werkzaamheden binnen de Milder Holland bv-werkplaats zullen kunnen geschieden, wordt geen arbeidsloon berekend. In dat geval zijn wel eventuele verzendkosten dan wel transportkosten voor rekening van de afnemer.

**4.5** Reclame dient schriftelijk en zo spoedig mogelijk te geschieden, doch uiterlijk 8 dagen na levering dan wel voltooiing der werkzaamheden of diensten ofwel -bij niet zichtbare gebreken- binnen 8 dagen nadat de gebreken redelijkerwijze konden worden geconstateerd, doch in ieder geval uiterlijk 8 dagen na het verstrijken van de garantietermijn.

**4.6** De afnemer heeft geen recht op garantie zolang hij de verschuldigde prestatie en/of het door hem ingevolge het bepaalde in artikel 5.4 hierna verschuldigde in geval van niet-nakoming, niet volledig heeft voldaan.

## Artikel 5: betaling

**5.1** Milder Holland bv factureert aan de afnemer, ongeacht welke persoon c.q. vennootschap de levering heeft verricht of de werkzaamheden feitelijk heeft uitgevoerd.

**5.2** Betaling dient te geschieden binnen de op de factuur vermelde betalingstermijn of, bij gebreke van een dergelijke vermelding, binnen dertig dagen na factuurdatum. Bij betaling binnen acht dagen na factuurdatum is de afnemer gerechtigd 2% korting te berekenen, op het goederenbedrag exclusief omzetbelasting.

**5.3** De afnemer heeft, anders dan hiervoor vermeld, geen recht op korting of verrekening.  
**5.4** Indien het factuurbedrag niet of niet helemaal op de overeengekomen datum is voldaan, is de afnemer zonder ingebrekestelling in verzuim. De afnemer is dan over (het niet betaalde deel

van) het factuurbedrag de wettelijke rente verschuldigd evenals een boete ter grootte van 1% per maand vanaf de vervaldag van de desbetreffende factuur tot aan de dag der algehele voldoening. Daarnaast komen de buitengerechtigde incassokosten voor rekening van de afnemer. Deze worden vastgesteld op het incassotarief van de Nederlandse Orde van Advocaten, (en berekend over het factuurbedrag, vermeerderd met de genoemde boete), met een minimum van € 250,-, tenzij Milder Holland bv aantoonde dat de door haar in redelijkheid gemaakte incassokosten meer hebben belopen, in welk geval zij gerechtigd is tot dat meerdere.  
**5.5** Reclame met betrekking tot de hoogte van het factuurbedrag dient schriftelijk en uiterlijk binnen acht dagen na factuurdatum te geschieden, bij gebreke waarvan de afnemer wordt geacht met het factuurbedrag te hebben ingestemd.

## Artikel 6: eigendomsvoorbehoud

**6.1** Milder Holland bv behoudt zich het eigendomsrecht van de aan de afnemer geleverde zaken voor, totdat de door de afnemer verschuldigde prestatie is voldaan, alsmede totdat het door de afnemer ingevolge het bepaalde in artikel 5.4 hiervoor verschuldigde ingeval van niet-nakoming is voldaan.

**6.2** De afnemer is niet gerechtigd de zaken waarop het bovengenoemde eigendomsvoorbehoud rust te verkopen of te verwerken buiten de normale uitoefening van zijn bedrijf, deze zaken te verpanden, of op welke wijze dan ook inbreuk te maken op het eigendomsrecht van Milder Holland bv.

**6.3** In geval het bepaalde in artikel 6.1 of 6.2 hiervoor van toepassing vindt en de afnemer een of meer daartuit voortvloeiende verplichtingen niet nakomt, wordt de afnemer geacht van rechtswege in verzuim te zijn en heeft Milder Holland bv het recht de uitvoering van de overeenkomst op te schorten of de overeenkomst geheel of gedeeltelijk te ontbinden, zonder dat zij tot enige schadevergoeding of garantie gehouden is en onverminderd het recht op schadevergoeding.

## Artikel 7: aansprakelijkheid Milder Holland bv

**7.1** De aansprakelijkheid van Milder Holland bv voor niet, niet tijdige of niet behoorlijke nakoming van de tussen Milder Holland bv en de afnemer gesloten overeenkomst is beperkt tot directe schade en zal het netto verkoopbedrag c.q. netto factuurbedrag niet te boven gaan. De aansprakelijkheid voor gevolgschade is volledig uitgesloten.

**7.2** Deze in artikel 7.1 genoemde aansprakelijkheidsbeperking geldt eveneens indien de afnemer of een derde schade lijdt als gevolg van handelen of nalaten van het personeel van Milder Holland bv of derden die bij de uitvoering van de overeenkomst zijn betrokken.

**7.3** De afnemer vrijwaart Milder Holland bv tegen alle eventuele aanspraken c.q. rechten van derden op vergoeding van geleden en nog te lijden schade die voortvloeit uit handelen of nalaten van Milder Holland bv c.q. haar personeel of een door Milder Holland bv bij de uitvoering van de overeenkomst ingeschakelde derde en waarvoor de afnemer op grond van de wet aansprakelijk kan worden gehouden, tenzij deze schade is veroorzaakt door grove nalatigheid van Milder Holland bv c.q. haar personeel of een door Milder Holland bv bij de uitvoering van de overeenkomst ingeschakelde derde.

**7.4** Milder Holland bv is niet aansprakelijk voor schade die ontstaat is door of in verband met normale slijtage, onoordeelkundige behandeling of gebruik dan wel onoordeelkundig of onjuist onderhoud van de door Milder Holland bv geleverde zaken.

**7.5** Indien de aansprakelijkheid van Milder Holland bv jegens de afnemer is vastgesteld en Milder Holland bv zou niet gerechtigd zijn haar aansprakelijkheid te beperken als genoemd in de artikelen 7.1 tot en met 7.4 hiervoor, dan zal deze aansprakelijkheid voor wat betreft schade aan personen en zaken in ieder geval zijn beperkt tot het door Milder Holland bv verzekerd bedrag per gebeurtenis.

## Artikel 8: overmacht

**8.1** In geval van overmacht is Milder Holland bv gerechtigd, hetzij de overeenkomst geheel of gedeeltelijk te beëindigen, hetzij de uitvoering van haar verplichtingen op te schorten, zonder tot schadevergoeding gehouden te zijn.

**8.2** Als overmacht worden beschouwd tekortkomingen die niet aan Milder Holland bv kunnen worden toegerekend en noch krachtens wet, rechtshandeling of in het verkeer geldende opvattingen voor haar rekening komen, zoals oorlog, overheidsmaatregelen, vertraging in de

aanvoer, transportmoeilijkheden, werkstakingen, gebrek aan voorraden, grondstoffen en/of arbeidskrachten, brand en andere storingen in het bedrijf van Milder Holland bv, uitvoer- en invoerbeodden en alle andere omstandigheden die de naleving van de overeenkomst door Milder Holland bv in ernstige mate bemoeilijken.

## Artikel 9: veiligheid

**9.1** De afnemer is gehouden zich aan de zijde van Milder Holland bv c.q. daartoe bevoegde instanties gegeven veiligheidsregels te houden en zich te gedragen volgens de terzake gegeven instructies en handleidingen.

**9.2** De afnemer is niet bevoegd de door Milder Holland bv geleverde zaken te gebruiken voor een ander doel dan in zijn overeenkomst met Milder Holland bv staat vermeld en/of met deze overeenkomst is bedoeld en/of uit de aard van de geleverde zaken voortvloeit.

## Artikel 10: ruil

Indien de afnemer gekochte zaken wenst terug te zenden of te ruilen is Milder Holland bv bevoegd, daarmee in te stemmen mits:

- a. de afnemer aan Milder Holland bv 15% van het factuurbedrag, betrekking hebbend op de terug te zenden of te ruilen zaken, vergoedt;
- b. de zaken niet in het bijzonder voor de afnemer zijn vervaardigd of gewijzigd (maatwerk);
- c. de zaken nieuw en in originele staat zijn;
- d. de zaken niet in grote hoeveelheden door de afnemer zijn besteld.

Een toezegging van Milder Holland bv tot ruiling of terugzending is slechts geldig, indien Milder Holland bv deze toezegging schriftelijk heeft gedaan.

## Artikel 11: emballage

**11.1** In rekening gebrachte emballage wordt, mits franco en in goede staat binnen 14 dagen na aflevering aan Milder Holland bv terugbezorgd, volledig vergoed.

**11.2** Indien de leverancier van Milder Holland bv, ook in het geval genoemd in artikel 11.1 hiervoor, de emballage niet volledig vergoed, zal deze korting aan de afnemer worden doorberekend.

## Artikel 12: verjaring

Alleen indien reclames op de in deze algemene of de aanvullende voorwaarden voorgescreven wijze ter kennis van Milder Holland bv zijn gebracht, zijn rechtsvorderingen en/of verwerpen van de afnemer ontvankelijk. Zij verjaren door verloop van een jaar na kennisgeving, behoudens het geval dat de afnemer aan een vordering tot betaling zijn recht op vermindering van de koopprijs tegenwerpt.

De verjaring loopt niet, zolang de afnemer zijn rechten niet kan uitoefenen als gevolg van opzet van Milder Holland bv

## Artikel 13: ontbinding

Geheel of gedeeltelijke ontbinding van de overeenkomst is voor partijen slechts mogelijk in de gevallen genoemd in deze algemene verkoop- en leveringsvoorwaarden. Daarnaast heeft Milder Holland bv het recht tot (gedeeltelijke) ontbinding van de overeenkomst indien de afnemer in verzuim is, in staat van falissement wordt verklaard, (voorlopige) surseance van betaling aanvraagt of door beslaglegging, onder curatelinstelling of anderszins de beschikkingsbevoegdheid over zijn vermogen of delen ervan verliest, of in geval van stillegging of liquidatie van diens onderneming, onverlet het recht van Milder Holland bv op volledige schadevergoeding. Alle vorderingen van Milder Holland bv zijn dan terstond opeisbaar.

## Artikel 14: bevoegde rechter

Alle geschillen, welke mochten ontstaan naar aanleiding van enige tussen de afnemer en Milder Holland bv gesloten overeenkomst, dan wel van nadere overeenkomsten, die daarvan het gevolg mochten zijn, zullen worden beslecht door gerechtelijke instanties.

## Artikel 15: toepasselijk recht

Op de door Milder Holland bv en een afnemer gesloten overeenkomst en nadere overeenkomsten die daaruit voortvloeien is uitsluitend het Nederlandse recht van toepassing.

Wijzigingen voorbehouden.

De algemene verkoop- en leveringsvoorwaarden zijn gedepeerd bij de Kamer van Koophandel Centraal Gelderland.

PE Drukleidingen > PVC Drukleidingen > PP Drukleidingen >  
Afstandbediende afsluiters > C-PVC Programma > Blue-system  
programma > Binnen- en buitenriolering > Kabelbescherming  
en telecom > Milieu programma > Tanks > Folie en geotextielen  
> Halffabrikaten > RVS Programma > Malleable programma  
> Sanitair en verwarming > Metalen appendages en fittingen  
> Slangen en koppelingen > Pompen, filters en kabel > Lijm,  
reiniger en toebehoren > Bevestigingsmaterialen > Machines  
en gereedschappen

#### Milder Bommel

*Industrieterrein Pannenhuis in Huissen*

Nijverheidstraat 28

6681 LN Bommel

Telefoon 026 - 325 91 03

#### Milder Rotterdam

*Industrieterrein Noordwest*

Sevillaweg 70-72

3047 AL Rotterdam

Telefoon 010 - 415 99 83

[info@milder.nl](mailto:info@milder.nl)

[www.milder.nl](http://www.milder.nl)

